

DH-PFB203W

Water-proof Wall Mount Bracket



Features

- Aesthetic design
- Water-proof wall mount bracket
- Material: aluminum & SECC

Technical Specifications

Model	DH-PFB203W
General	
Material	Aluminum & SECC
Dimension(WxHxD)	160mmx122mmx76mm (6.30"x4.80"x2.99")
Weight	0.5kg(1.1lb)
Load Bearing	1kg(2.2lb)
Color	White
Operating Temperature	-40°C ~ +60°C (-40°F ~ +140°F)
Humidity	<90% RH
Applicable Model	Please see "Accessory Selection"

Order Information

Type	Part Number	Description
Camera Mount	DH-PFB203W	Wall mount bracket
	PFB203W	Wall mount bracket

Dimensions (mm/inch)

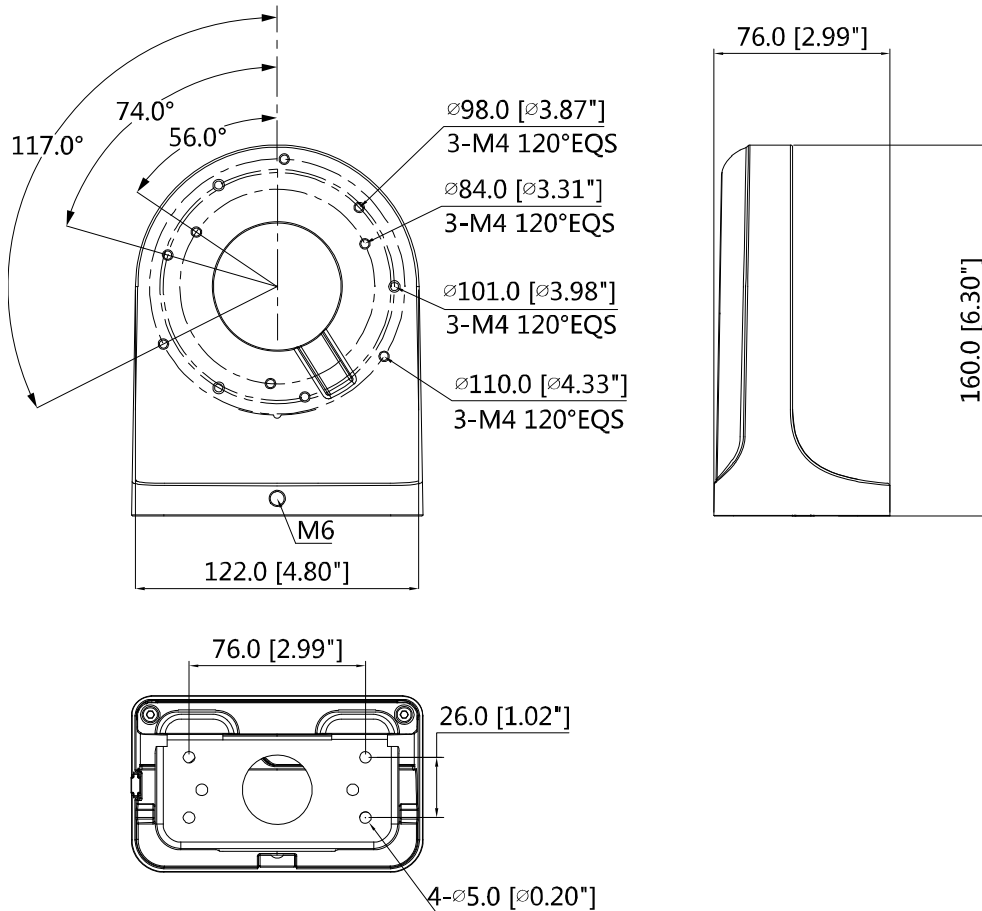

Application

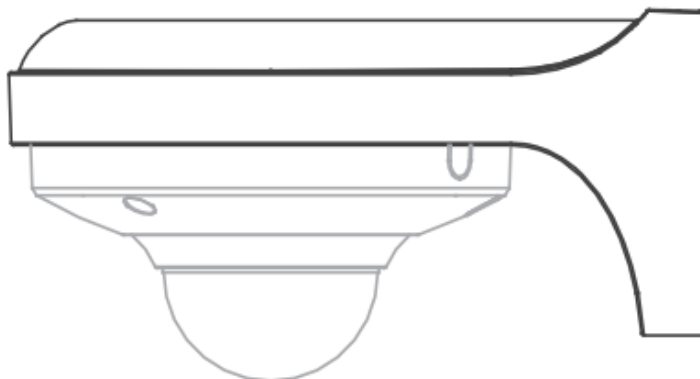

Package Information

- Wall mount bracket *1
- M4 screw *3
- ST4 screw *4
- Plastic anchor *4
- Wrench *1