

Walk-through Metal Detector

User's Manual







Foreword

General

This manual introduces the functions and operations of the walk-through metal detector (hereinafter referred to as the "Detector").

Safety Instructions

The following signal words might appear in the manual.

Signal Words	Meaning
 DANGER	Indicates a high potential hazard which, if not avoided, will result in death or serious injury.
 WARNING	Indicates a medium or low potential hazard which, if not avoided, could result in slight or moderate injury.
 CAUTION	Indicates a potential risk which, if not avoided, could result in property damage, data loss, reductions in performance, or unpredictable results.
 TIPS	Provides methods to help you solve a problem or save time.
 NOTE	Provides additional information as a supplement to the text.

Revision History

Version	Revision Content	Release Time
V1.0.1	Update port description. Add the temperature overlay function and detector upgrade.	November 2021
V1.0.0	First release.	June 2021

Interface Declaration

This manual mainly introduces the relevant functions when you use the Device. The interfaces used for manufacture, returning to the factory for inspection, and locating fault are not described in this manual. Please contact technical support if you need information about these interfaces.

Privacy Protection Notice

As the device user or data controller, you might collect the personal data of others such as their face, fingerprints, and car plate number. You need to be in compliance with your local privacy protection laws and regulations to protect the legitimate rights and interests of other people by implementing measures which include but are not limited: Providing clear and visible identification to inform people of the existence of the surveillance area and provide required contact information.

About the Manual

- The manual is for reference only. Slight differences might be found between the manual and the product.
- We are not liable for losses incurred due to operating the product in ways that are not in compliance with the manual.
- The manual will be updated according to the latest laws and regulations of related jurisdictions.

For detailed information, see the paper user's manual, use our CD-ROM, scan the QR code or visit our official website. The manual is for reference only. Slight differences might be found between the electronic version and the paper version.

- All designs and software are subject to change without prior written notice. Product updates might result in some differences appearing between the actual product and the manual. Please contact customer service for the latest program and supplementary documentation.
- There might be errors in the print or deviations in the description of the functions, operations and technical data. If there is any doubt or dispute, we reserve the right of final explanation.
- Upgrade the reader software or try other mainstream reader software if the manual (in PDF format) cannot be opened.
- All trademarks, registered trademarks and company names in the manual are properties of their respective owners.
- Please visit our website, contact the supplier or customer service if any problems occur while using the device.
- If there is any uncertainty or controversy, we reserve the right of final explanation.

Important Safeguards and Warnings

This chapter describes the contents covering proper handling of the Device, hazard prevention, and prevention of property damage. Read these contents carefully before using the Device, comply with them when using, and keep the manual well for future reference.

Transportation Requirements



Transport the Device under the allowed humidity and temperature conditions.

Storage Requirements



- Keep the Device away from dampness, dust or soot.
- Store the Device under the allowed humidity and temperature conditions.

Installation Requirements



- Do not place or install the Device in a place exposed to sunlight or near the heat source.
- Keep the Device installed horizontally on a stable place to prevent it from falling.
- Install the Device in a well-ventilated place, and do not block the ventilation of the Device.

Operation Requirements



- Do not drop or splash liquid onto the Device, and make sure that there is no object filled with liquid on the Device to prevent liquid from flowing into the Device.
- Operate the Device within the rated range of power input and output.
- Do not disassemble the Device.
- Use the Device under the allowed humidity and temperature conditions.

Maintenance Requirements



- Use the battery of specified manufacturer; otherwise there might result in explosion. When replacing battery, make sure that the same type is used. Improper battery use might result in fire, explosion, or inflammation.
- Always replace with the same type of batteries.
- Use the recommended power cables in the region and conform to the rated power specification.
- Use the power adapter provided with the Device; otherwise, it might result in people injury and device damage.



- Use power supply that meets ES1 but does not exceed PS2 limits defined in IEC 62368-1. For specific power supply requirements, refer to device labels.
- Connect the Device (I-type structure) to the power socket with protective earthing.
- The appliance coupler is a disconnection device. Keep the angle for easy operation.

Table of Contents

Foreword	I
Important Safeguards and Warnings.....	III
1 Overview	1
1.1 Introduction	1
1.2 Technical Advantages	1
2 Structure	2
2.1 Dimensions	2
2.2 Port	3
3 Installation	5
3.1 Checklist.....	5
3.2 Environment Requirements	5
3.3 Installing Detector	6
3.4 Multiple Walk-through Detectors Site Installation	8
3.5 Stabilizing Detector.....	9
4 Detector Configuration	10
4.1 Configuration Panel	10
4.2 Remote Control.....	11
4.3 Detector Operations.....	12
4.3.1 Password Setting	12
4.3.1.1 Login.....	12
4.3.1.2 Changing Password	12
4.3.2 Setting Date&Time.....	13
4.3.3 Setting Sensitivity	14
4.3.4 Setting Security Level.....	16
4.3.5 Setting Frequency	16
4.3.6 Setting Application Program	18
4.3.7 Setting Alarm Audio.....	19
4.3.8 Setting Temperature Overlay.....	20
4.3.9 Setting System Parameters	21
4.3.9.1 General.....	22
4.3.9.2 Setting Network	24
4.3.9.3 Setting Alarm Rules	25
4.3.9.4 Setting Infrared Start-stop.....	27
4.3.9.5 Viewing Device Information.....	29
4.3.9.6 Diagnosis.....	30

4.3.10 Viewing Alarm Record	31
4.3.11 Restore.....	31
4.4 Adjusting Detection Ability.....	33
5 Detector Upgrade.....	34
5.1 Searching for Detector.....	34
5.2 Upgrading Detector	35
5.3 Changing Password.....	36
6 FAQ	37
Appendix 1 Cybersecurity Recommendations.....	39

1 Overview

1.1 Introduction

The device is a high-performance walk-through metal detector. It is light-weighted and has high metal detection sensitivity, strong anti-interference capabilities and stable performance. The device, made of high-strength special materials, is light-weighted and easy to transport and install. The device has a modular design and is manufactured on unified assembly lines, ensuring the good stability. It also delivers a simplicity and user-friendly interface.

The walk-through metal detector is suitable for use in the following scenarios: Security screening of prohibited metal items in law enforcement sites such as public security, the procuratorate, tribunal, labor camp, and detention house. It is also suitable for security checks at the entrances of public spaces, including stadiums, entertainment places, airports, customs, exhibition halls and museums.

1.2 Technical Advantages

- Start-stop Technology
The IR units support manual start-stop technology for longer service life.
- Adjustable Sensitivity
The sensitivity of each detection zone can be adjusted as needed to meet different sensitivity requirements of different zones.
- Alarm
Light and sound alarm for sharp alert. The sound duration and volume can be adjusted as needed.
- Search
The system supports real-time search.
- Detection Capability
60 to 100 people detected per min.
- Filtering
Pre-define metal item weight, volume, size, part; exclude keys, jewelries, belt buckles and more.
- Security Protection
In line with EMC electromagnetic radiation standards and adopting weak magnetic field technology, the Device is harmless to cardiac pacemaker wearers, pregnant women, floppy disks, film, and videotapes.

2 Structure

2.1 Dimensions

Figure 2-1 Dimensions (unit: mm [inch])

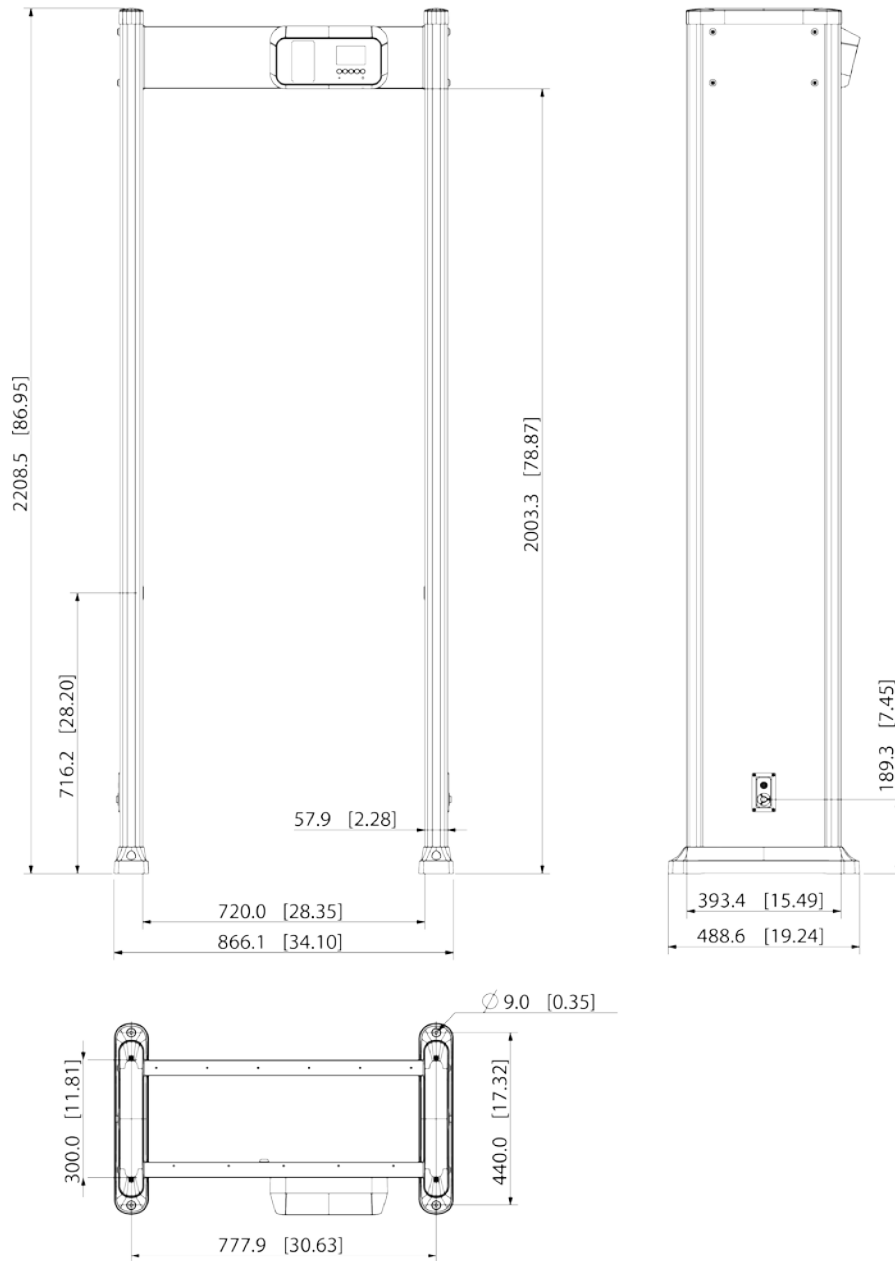

2.2 Port

Figure 2-2 Port (1)



Figure 2-3 Port (2)

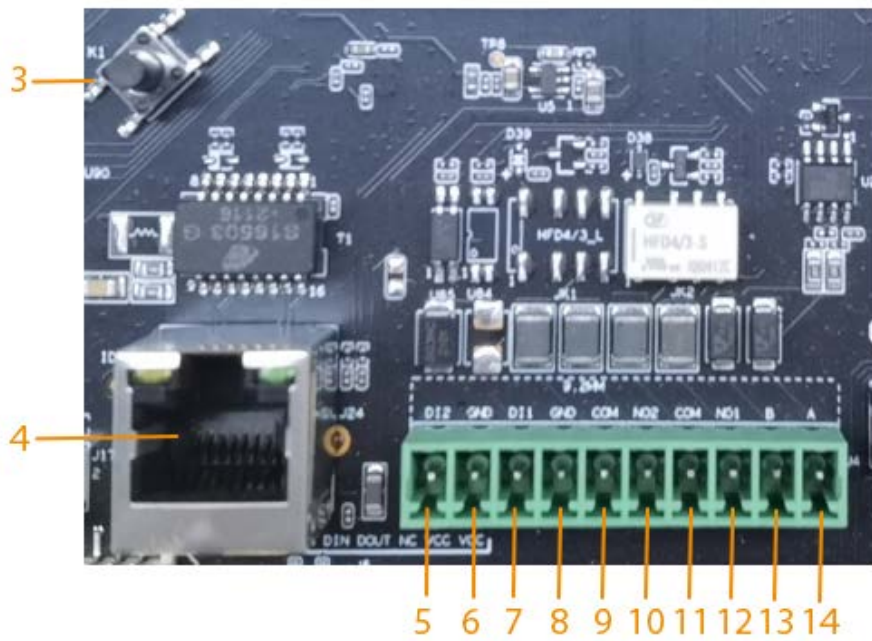



Figure 2-4 Port (3)



Table 2-1 Port description

No.	Name	Description
1	Power supply switch	Turns on or off the Device.
2	Power input port	Connects to power cable to get power supply.
3	Reset button	Long press the button for more than 5 s to restore the detector to factory default.
4	Ethernet port	Connects to network with network cable.
5	Alarm in +	Receives the signal of external alarm source.
6	Alarm in-	
7	NC	Reserved port.
8		
9		
10		
11	Alarm out C	Outputs alarm signal to alarm device.
12	Alarm out NO	
13	RS-485 B	Controls external devices, such as PTZ.
14	RS-485 A	 <ul style="list-style-type: none"> • Connect A and B cables (which both control RS-485) to devices such as PTZ cameras. • If there are a large number of PTZ decoders, connect A and B cables to 120 Ω resistors.
15	DB25	Signal port for metal detection.
16	Power in	Inputs 12 VDC power. Be sure to supply power as instructed in the manual.  Device damage might occur if power is not supplied correctly.
17	Power out	Outputs 12 VDC power.

3 Installation

3.1 Checklist

After receiving the product, check against the table below. If there are any problems, contact the after-sales service personnel.

Table 3-1 Checklist

No.	List	Description	
1	Overall packaging	Appearance	Obvious damage
		Packaging	Accidental impact
		Accessories	Complete or not
2	Host	Appearance	Obvious damage
		Model	Whether consistent with the order contract

Table 3-2 Packing list

Name	Quantity
Detector panel	2
Host box	1
Beam	2
Power cable (power input)	1
DB25 cable	2
Fixing screws (M6 × 16)	4
Fixing screws (M8 × 80)	8
Remote control	1
Wrench	1

3.2 Environment Requirements

- The ground is flat and sturdy
The ground should be flat and firmly supporting to prevent vibration. If there is a vibrating metal structure under the ground, there can be unnecessary alarm when people pass through the metal detector.
Do not install the detector on a metal ground.
- Keep away from fixed metal objects
Large metal objects that are fixed or immobile should be at least 50 cm away from the detector (detecting large metal objects) because they might make the Device more susceptible to vibration.



The distance in this section is the recommended distance. The actual installation distance depends on the installation site conditions.

- Keep away from moving metal objects
Large moving metal objects should be kept 0.5 m to 2 m away from the detector to avoid false alarms. Depending on the size of the metal object, the distance between the moving metal object and the detector might vary.
- Keep away from radioactive electronic interference
The distance between the electronic interference source and the receiving coil should be as large as possible. The recommended minimum distance is 0.5 m to 4 m. However, the actual distance needs to be based on specific circumstances. For example, you can go through a metal detector with a source of interference until the best position is found. Interference can occur from electronic control panels, radios and computers, image displays, high-power motors and transformers, AC wires, transistor control circuits, flash fluorescent tubes, arc welding equipment, and more.
- Keep away from conductive electronic interference
Connect the power cable to a line that is not connected to other large loads, such as high-power motors, because they can cause a large power or voltage shock in the line.

3.3 Installing Detector

Step 1 Open the packing box and take out the accessories.

Step 2 Open the front beam with the key, and then attach the host box to the front beam with four M6 × 16 screws.

Figure 3-1 Attach host box

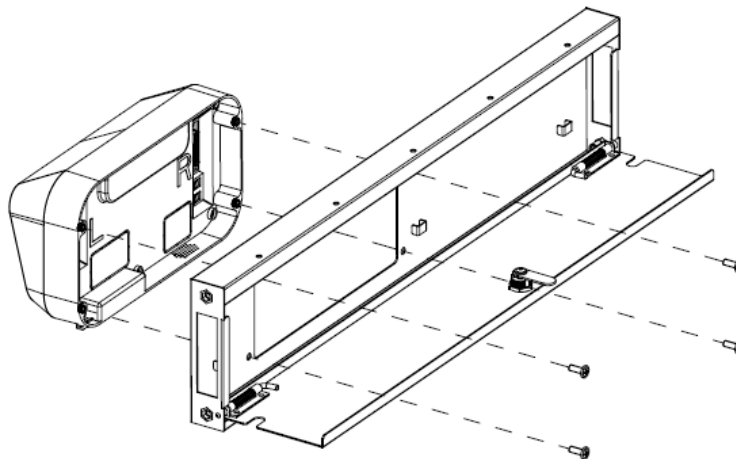

Step 3 Connect two DB25 cables and one power cable to the host box, and then separately run the two DB25 cables through the two holes at the two ends of the beam. Select one end of the beam, and then run the power cable.

Figure 3-2 Connect to host box

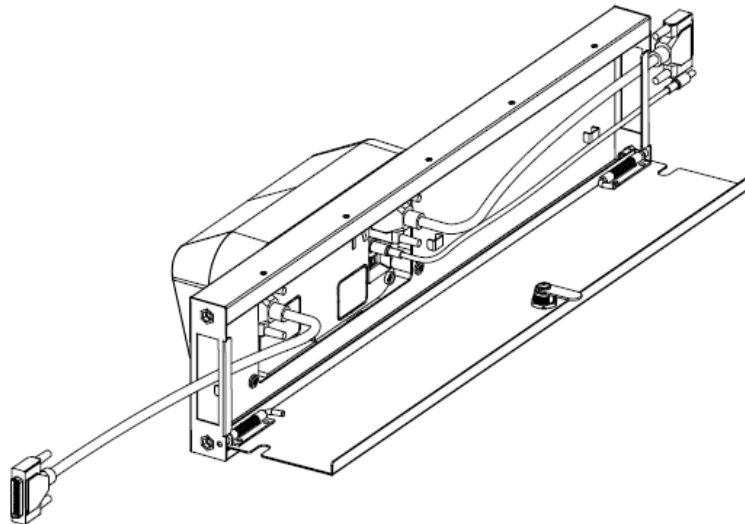

Step 4 Connect one end of the two DB25 cables and power cable to one detector panel, and then attach the front beam and rear beam to the detector panel with four M8 × 8 screws.

Figure 3-3 Attach beams (1)

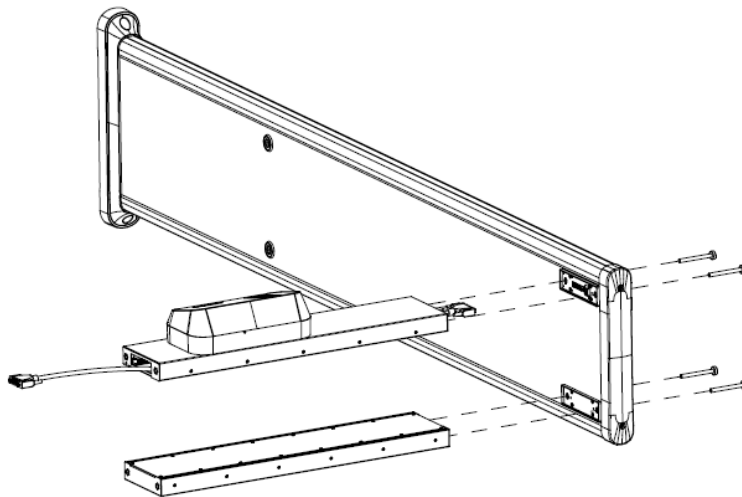

Step 5 Connect the other end of the two DB25 cables and power cable to one detector panel, and then attach the front beam and rear beam to the detector panel with four M8 × 8 screws.

Figure 3-4 Attach beams (2)

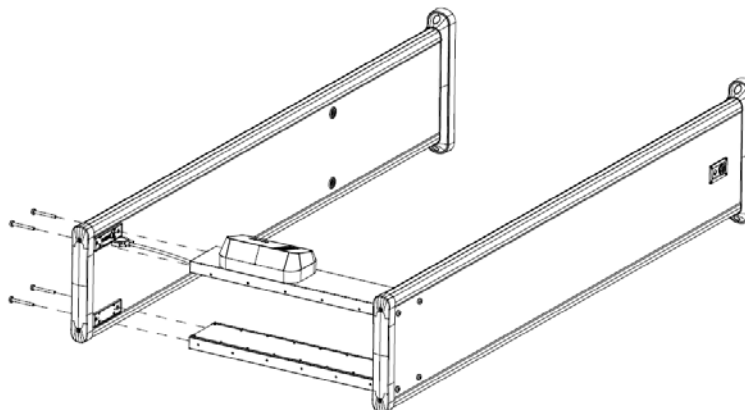

Step 6 Stand the Detector up.

Figure 3-5 Stand the Detector up

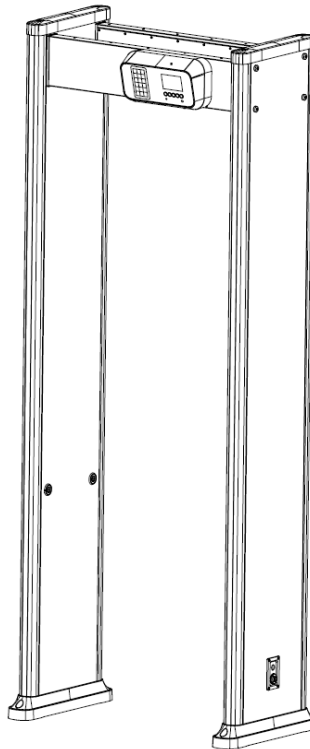

Step 7 Connect the power supply to the Detector, and then turn on the power switch to start the Detector.

3.4 Multiple Walk-through Detectors Site Installation

When installing multiple devices, space the devices at least 50 cm, and also space the device and X-ray security screening machine larger than 50 cm. This recommended spacing can make the little metal objects (such as coin) detected. If you install the devices with space smaller than 50 cm, there might be false alarm. If the spacing needs to be shorten because of limited installation site, you need to adjust the frequency, lower the security level and sensitivity according to the actual situation; otherwise, small metal objects might not be detected.

Figure 3-6 Multiple walk-through detectors site installation

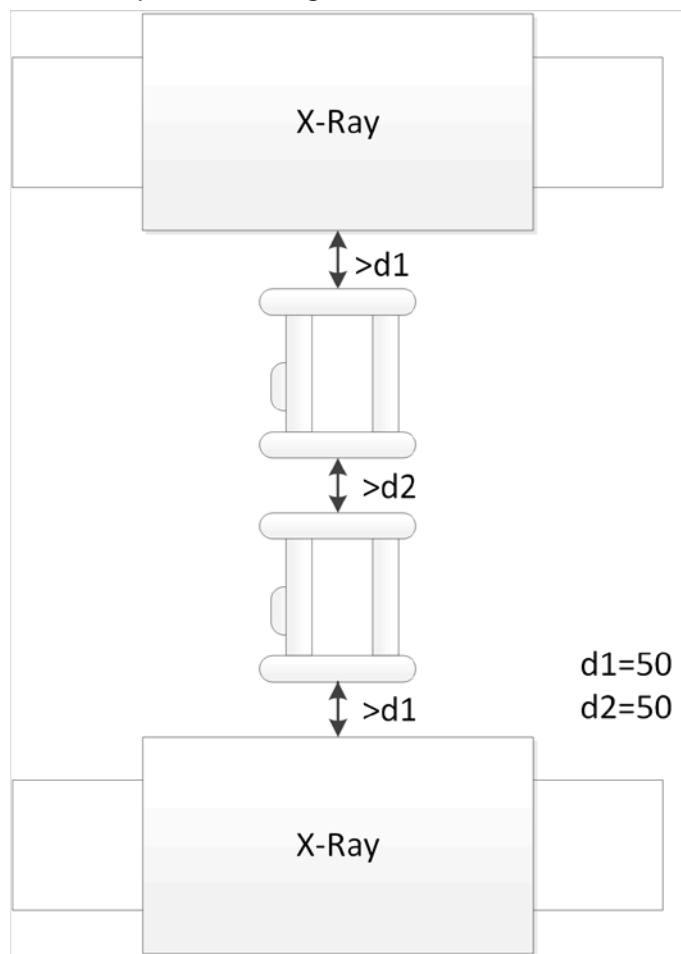

3.5 Stabilizing Detector

To make the Device work normally, stabilize the Device before use by tightening the fixing screws.

Figure 3-7 Tighten the fixing screws



4 Detector Configuration

4.1 Configuration Panel

Figure 4-1 Configuration panel

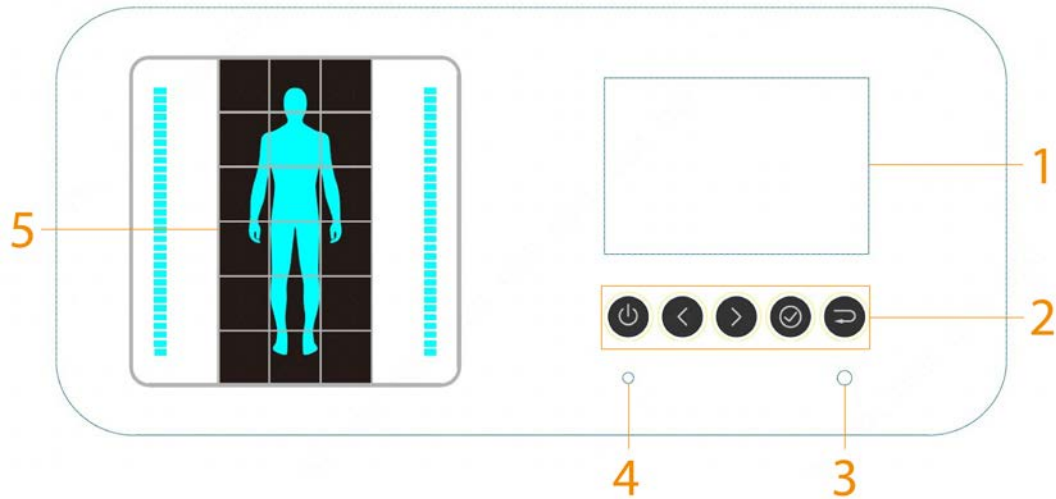









Table 4-1 Configuration panel description

No.	Description	
1	<p>Displays number of passes, alarm times, signal strength bar, mode (normal, test, or alarm), current working frequency, volume and time.</p> <p></p> <ul style="list-style-type: none"> With increase of the detected metals, the color will grow from green to red. There are 10 degrees: Degree 1-4 is green, degree 5-7 is yellow, and degree 8-10 is red. When the degree is up to 8, an alarm will be triggered. Different colors of mode icon indicate different modes: <ul style="list-style-type: none"> Yellow: Test mode. Green: Normal mode. Red: Alarm. 	
2		<ul style="list-style-type: none"> Power switch. Turn on or off the Device. Press and hold the button for 3 s to clear the counting data.
		Select buttons. Press  or  to move the cursor.
		<ul style="list-style-type: none"> Go to the parameter setting interface. Set parameter value. Confirm and save settings.
		Returns to the previous menu or exits the menu setting interface.
3	IR sensor.	
4	Power indicator light.	

No.	Description
5	Displays metal position indication with 18 indicators (red zone).  This function is only available on 18-zone detectors.

4.2 Remote Control

You can set the parameters of the Device remotely through the remote control. Install the batteries before using the remote control.

Figure 4-2 Remote control



Table 4-2 Operation description

No.	Name	Description
1	Power	Turn on or off the Device.
2	Reset	Press the button, and the number of passes and alarm times will be cleared.
3	Direction	<ul style="list-style-type: none"> Press the buttons to switch and select menus. When setting a parameter, press left or right button to move the cursor, and then press up or down button to change the number or parameter value.
4	Confirm	<ul style="list-style-type: none"> Go to the parameter setting interface. Confirm and save the setting.
5	Menu	Press the button to switch menus quickly. If the current parameter is the last one, press this button to switch to the first one.
6	Back	Returns to the previous menu or exits the menu setting interface.
7	Home	Go to the home page.

4.3 Detector Operations

4.3.1 Password Setting

4.3.1.1 Login

You can log in to the Device with the default password (000000). Change the password the first time you use it.

Procedure

- Step 1 Connect the power supply, press the switch button.
The main interface is displayed.
- Step 2 Enter the password.
Press ◀ or ▶ to move the cursor, and then press ⌂ to set the number.
- Step 3 Press ▶ to move the cursor to **OK**, and the press ⌂ to confirm the password.
If the password is wrong, the error note will be displayed.

Figure 4-3 Password error

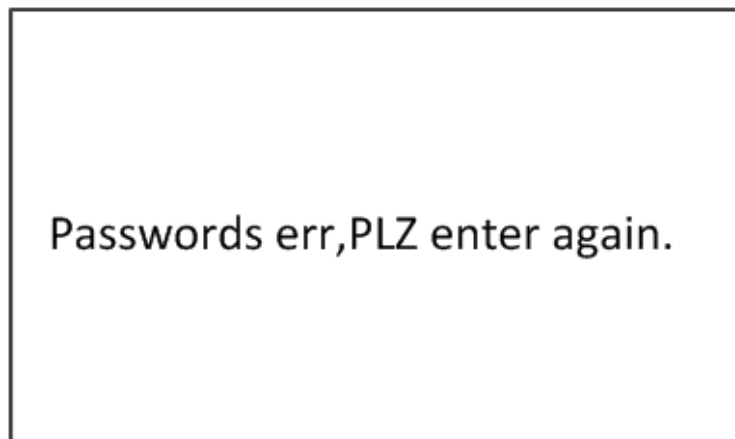

Related Operations

If you forget the password, long press the reset button for more than 5 s to restore the Detector, and then the Detector restarts.

4.3.1.2 Changing Password

Change the password regularly for the device safety.

- Step 1 Log in to the Detector. For details, see "4.3.1.1 Login".

Figure 4-4 Setting

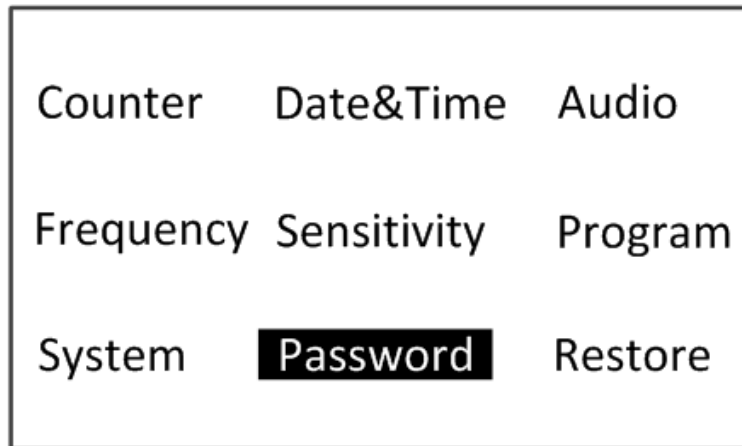

Step 2 Press ◀ or ▶ to move the cursor to **Password**, and then press ⏹ to go to the password setting interface.

Figure 4-5 Password setting

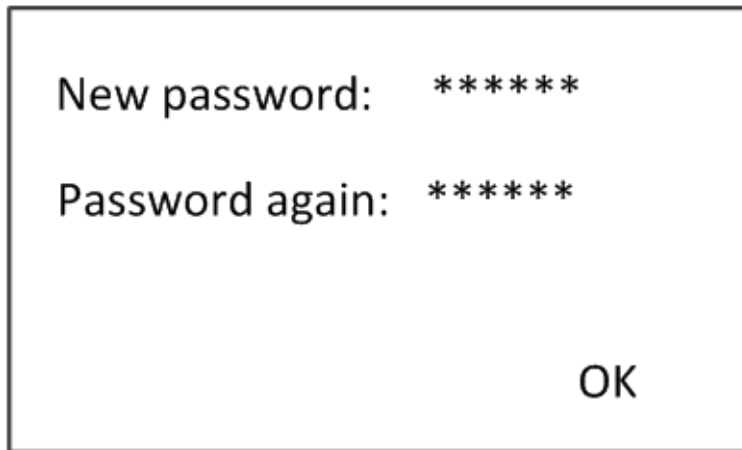

Step 3 Enter a new password, and then confirm the password. Move the cursor to **OK**, and then press ⏹ to confirm the setting.
For details of entering password, see "4.3.1.1 Login".

4.3.2 Setting Date&Time

Step 1 Log in to the Detector. For details, see "4.3.1.1 Login".

Figure 4-6 Date&Time setting

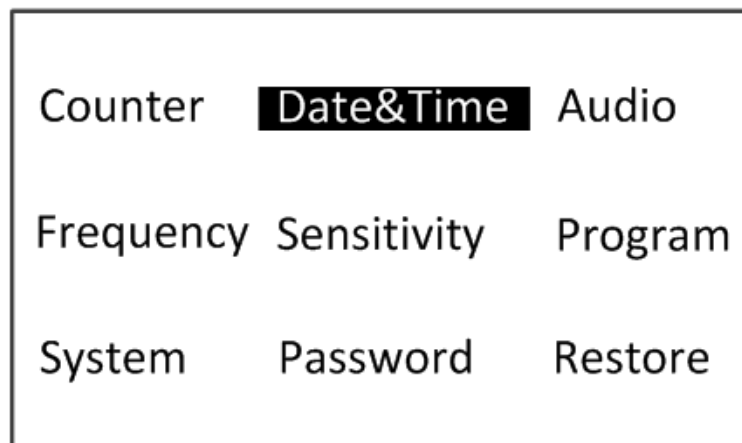

Step 2 Press ◀ or ▶ to move the cursor to **Date&Time**, and then press ⏹ to go to the time setting interface.

Figure 4-7 Set time

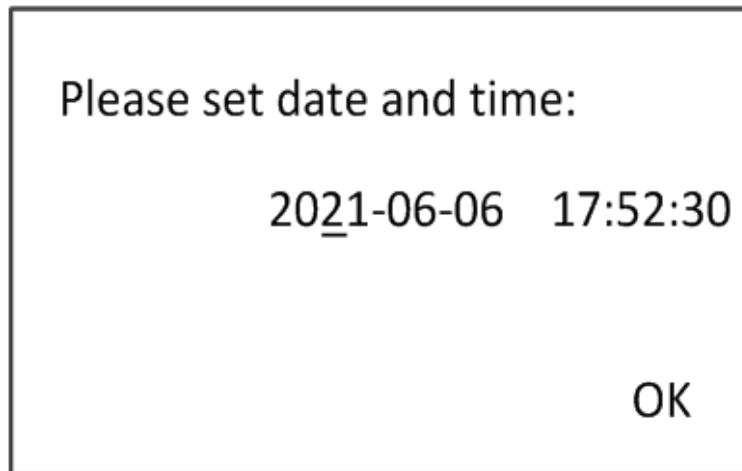

Step 3 Press ◀ or ▶ to move the cursor, and then press ⏹ to set the value.



The time format is YYYY-MM-DD.

Step 4 Press ▶ to move the cursor to **OK**, and then press ⏹ to save the setting.

4.3.3 Setting Sensitivity

Sensitivity can be set separately for each zone. It ranges from 0 to 255. The higher the value is, the more sensitive the Device is.

Step 1 Log in to the Detector. For details, see "4.3.1.1 Login".

Figure 4-8 Sensitivity setting

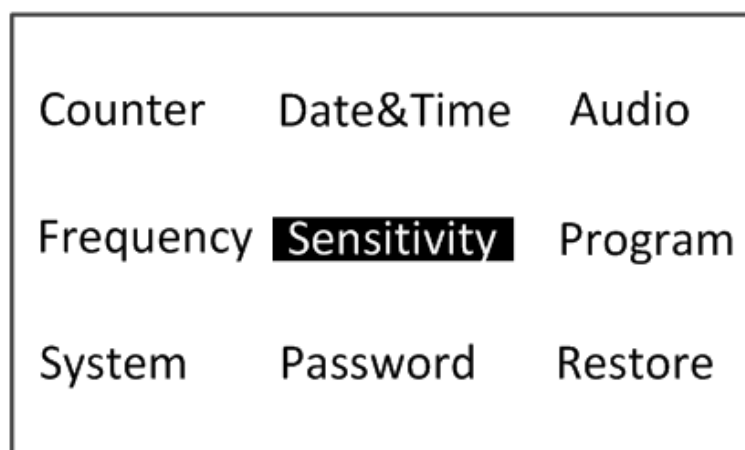

Step 2 Press ◀ or ▶ to move the cursor to **Sensitivity**, and then press ⏹ to go to the sensitivity setting interface.

Figure 4-9 Set sensitivity

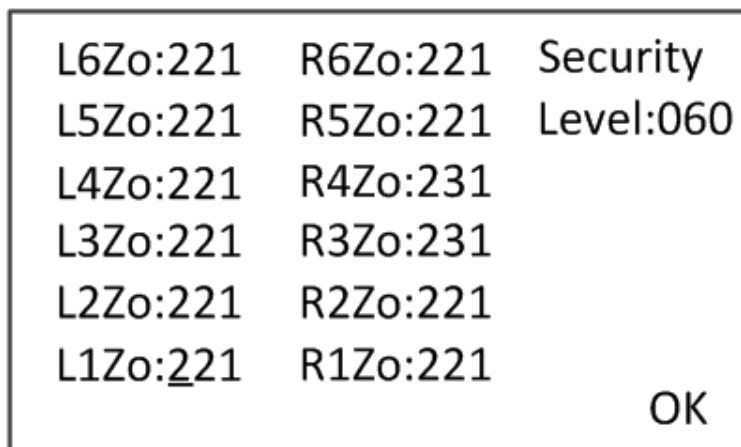

Step 3 Select the zone that needs to be set, and then set sensitivity.

Press ◀ or ▶ to move the cursor to a zone (for example, L1Zo), and then press ⏹ to set the value.

- L1Zo–L6Zo: The detection sensitivity of left detector panel (models with 12 zones and 18 zones) and models with 6 zones.
- R1Zo–R6Zo: The detection sensitivity of right detector panel (models with 12 zones and 18 zones).

Figure 4-10 Setting security level

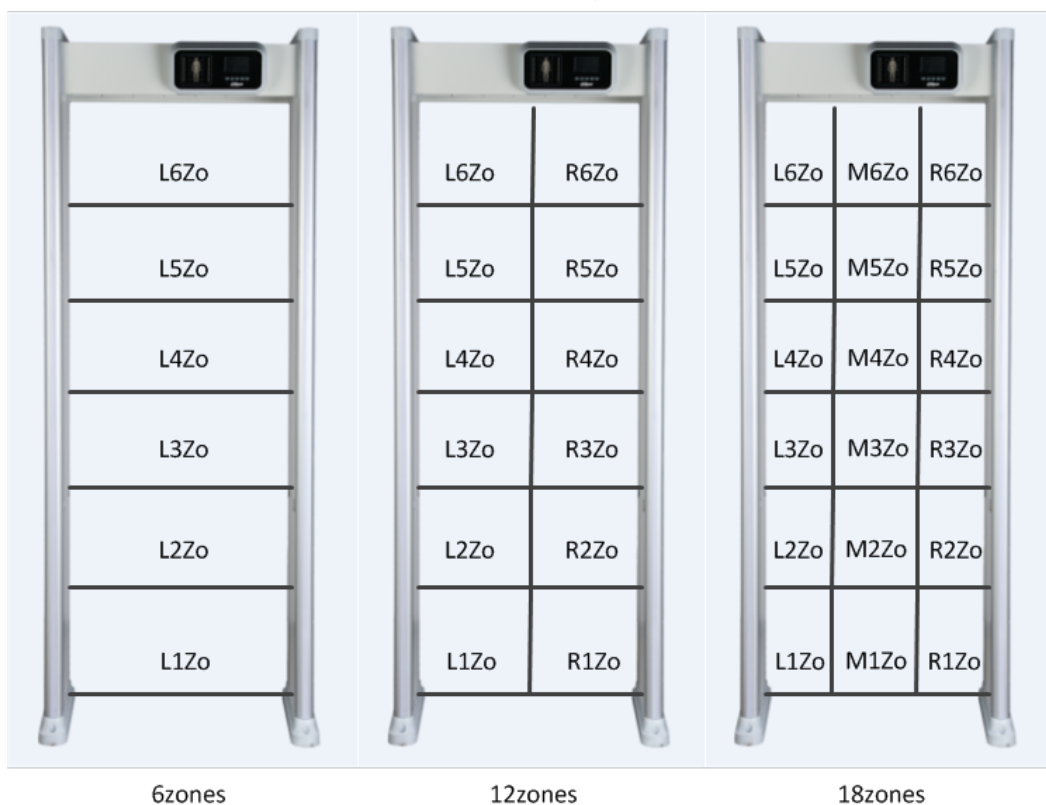

Step 4 Press ▶ to move the cursor to **OK**, and then press ⏹ to save the setting.

Result

When both the defined threshold of security level and sensitivity are reached, an alarm will be triggered.

When both the defined threshold of security level and sensitivity are reached, an alarm will be triggered. For the details of sensitivity, see "4.3.4 Setting Security Level".

4.3.4 Setting Security Level

Security level is the detection sensitivity of the Device. It ranges from 1 to 512. The higher the value is, the more sensitive the Device is.



Security level setting is not required in daily use.

Step 1 Log in to the Detector. For details, see "4.3.1.1 Login".

Figure 4-11 Security level setting

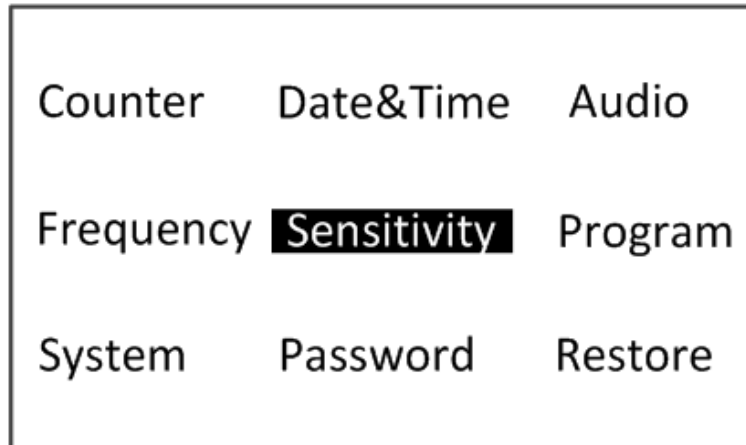

Step 2 Press or to move the cursor to **Sensitivity**, and then press to go to the security level setting interface.

Figure 4-12 Set security level

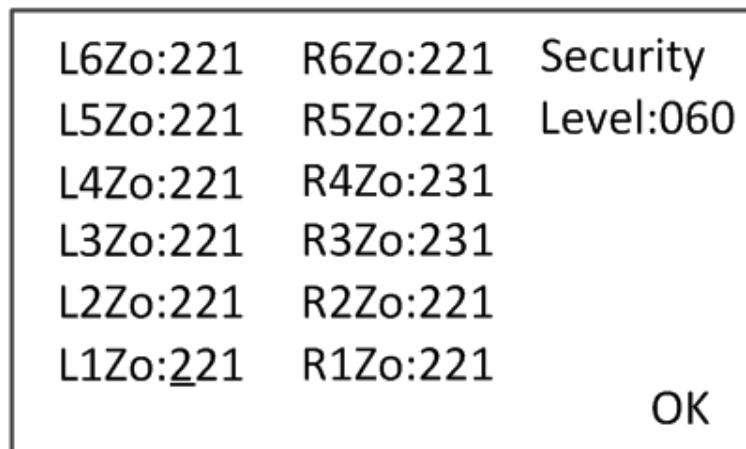

Step 3 Set security level.

Press or to move the cursor to **Security Level**, and then press to set the value.

Step 4 Press to move the cursor to **OK**, and then press to save the setting.

Result

When both the defined threshold of security level and sensitivity are reached, an alarm will be triggered. For the details of sensitivity, see "4.3.3 Setting Sensitivity".

4.3.5 Setting Frequency

Electromagnetic interference from ambient environment varies with different frequencies. The

frequency for lower interference makes the Device have higher sensitivity. When multiple devices work simultaneously, set different frequencies for each device to reduce mutual interference. The Device can search the frequency for lowest interference, and sets it to the working frequency. You can also set the frequency manually. It ranges from 1 to 20.

Step 1 Log in to the Detector. For details, see "4.3.1.1 Login".

Step 2 Press ◀ or ▶ to move the cursor to **Frequency**, and then press ⏹ to go to the frequency setting interface.

Figure 4-13 Frequency setting

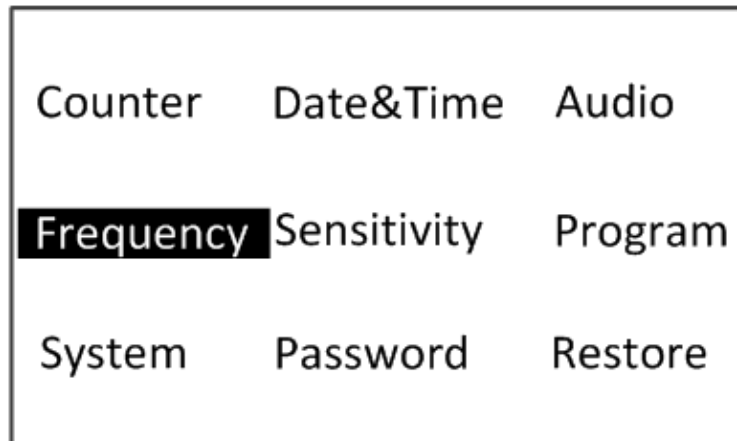

Step 3 Set the frequency.

- Auto search frequency: Press ◀ or ▶ to move the cursor, and press ⏹ to enable the auto search frequency function. The Device will set the suitable working frequency automatically. If the working frequency still needs to be adjusted, you can set the value manually.



- ◇ Do not pass or approach to the detector during auto searching.
- ◇ Alarm might be triggered during auto searching. Auto-searching function lasts about 2 minutes
- Set frequency manually: When the auto search frequency function is disabled, press ◀ or ▶ to move the cursor, and then press ⏹ to set the value manually.

Figure 4-14 Set frequency

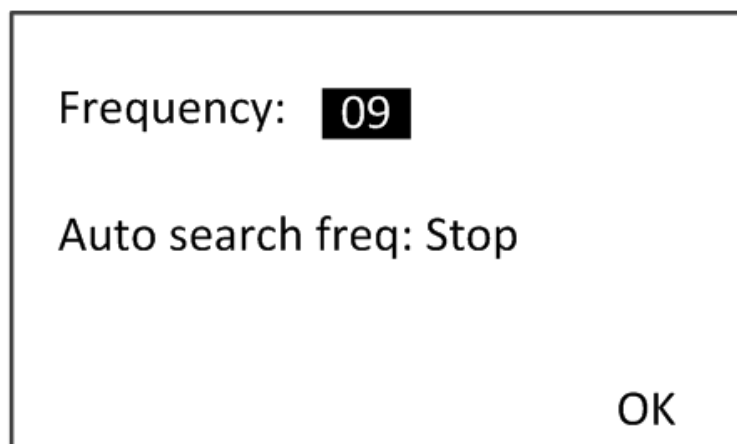

Step 4 Press ▶ to move the cursor to **OK**, and then press ⏹ to save the setting.

4.3.6 Setting Application Program

The Device supports 12 programs, which correspond to different sensitivity levels. After selecting the scene, the Device sets the suitable sensitivity level for each scene automatically.

Step 1 Log in to the Detector. For details, see "4.3.1.1 Login".

Figure 4-15 Application program setting

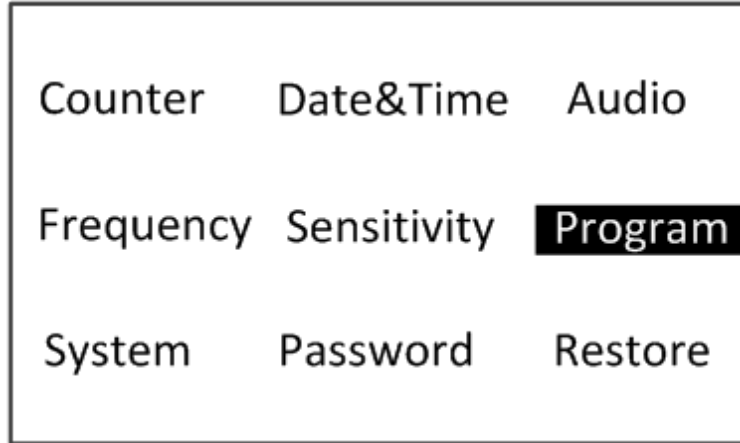

Step 2 Press ◀ or ▶ to move the cursor to **Program**, and then press ⏹ to go to the application scenarios setting interface.

Figure 4-16 Set application scenarios

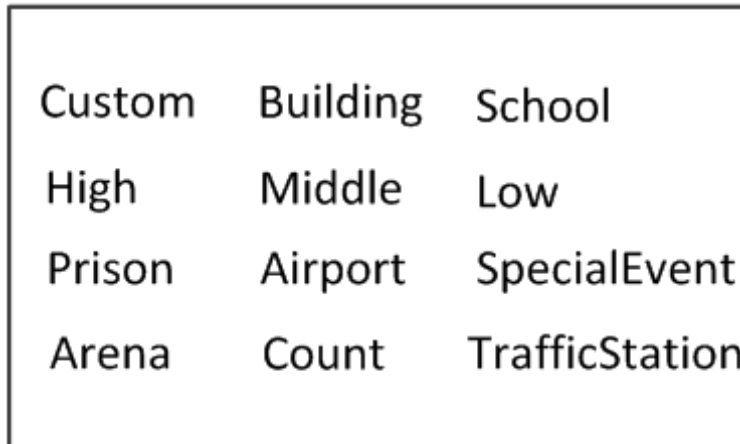

Table 4-3 Application scenes

No.	Scenes	Description
1	High, Prison, Court	The detection capacity is largest, and the detection targets include harmless items and hazardous items, the minimum detection target is a CNY coin.
2	Middle, Building	Detects metal objects such as mini guns, and filters harmless metals such as glasses, watches, belt buckles, and coins.
3	Low	Detects metal objects such as gun, and filters harmless metals such as glasses, watches, belt buckles, and coins.
4	School, SpecialEvent, Arena	Detects guns, knives longer than 12 cm, and filters harmless metals such as glasses, watches, belt buckles, and coins.

No.	Scenes	Description
5	Logistics, Airport, TrafficStation	Detects metal objects such as guns, knives longer than 10 cm, pocket knives, and daggers; filters harmless metals such as glasses, belt buckles, and coins.

Step 3 Press ◀ or ▶ to move the cursor to select an application scenario, and then press ⏹.

4.3.7 Setting Alarm Audio

You can set alarm audio parameters, including tone, volume, and duration.

Step 1 Log in to the Detector. For details, see "4.3.1.1 Login".

Figure 4-17 Audio setting

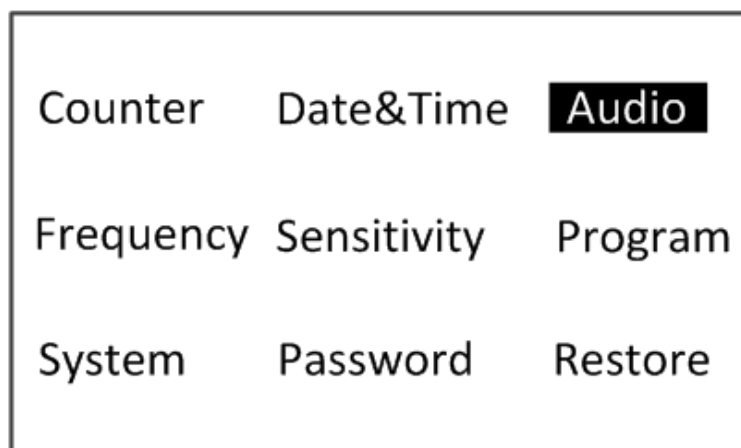

Step 2 Press ◀ or ▶ to move the cursor to **Audio**, and then press ⏹ to go to the audio setting interface.

Figure 4-18 Setting audio

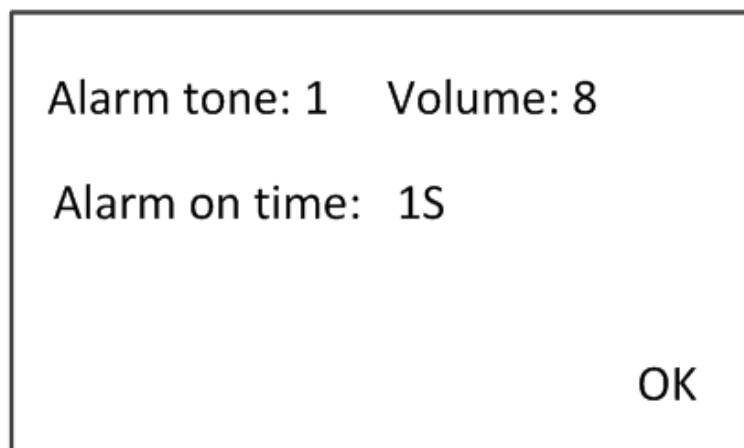

Step 3 Press ◀ or ▶ to move the cursor to **Alarm tone**, **Volume**, or **Alarm on time**, and then press ⏹ to set the value.

- Alarm tone: Select one alarm tone from the 9 built-in tones, and it will be played when an alarm is triggered.
- Volume: Adjust the alarm volume. The bigger the number, the higher the volume.
- Alarm on time: Set alarm duration (0 s–10 s).



When the alarm duration is 0 s, the alarm light of the detector panel is not on, and the metal position indicator of the detector is not on.

Step 4 Press to move the cursor to **OK**, and then press to save the setting.

4.3.8 Setting Temperature Overlay

After you enable the temperature overlay function, body temperature and the number of temperature alarms will be displayed on the screen.

Step 1 Log in to the Detector. For details, see "4.3.1.1 Login".

Step 2 Press or to move the cursor to **System**, and then press .

Figure 4-19 System

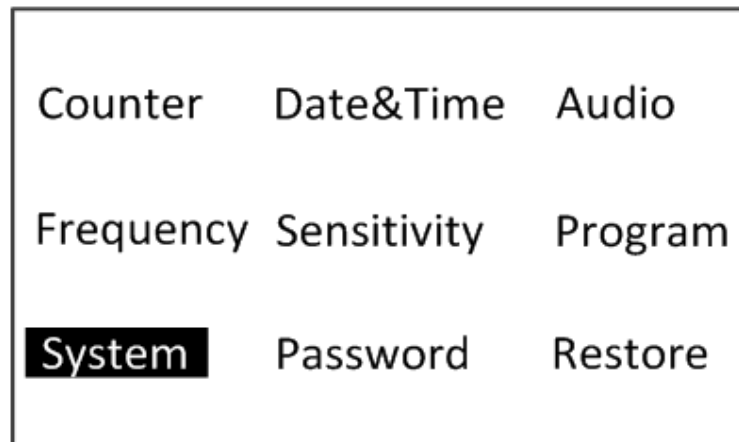

Step 3 Press or to move the cursor to **Alarm**, and then press .

Figure 4-20 Alarm

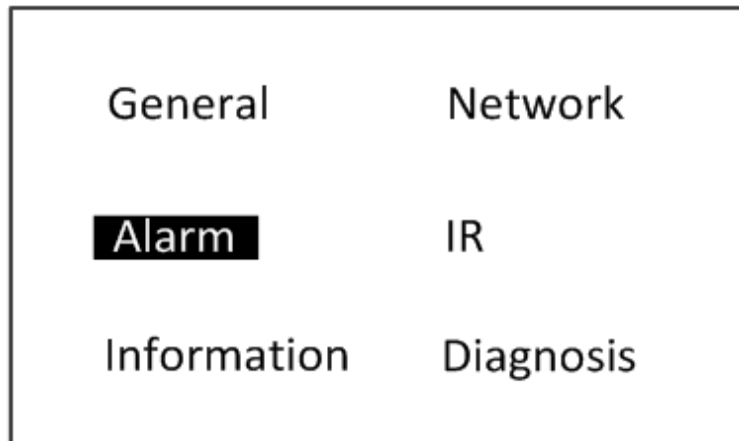

Step 4 Press or to move the cursor to **ON**, and then press to enable the temperature overlay function.





Press , **ON** becomes **OFF**, and then press  to disable the function.

Figure 4-21 Set Temp Overlay



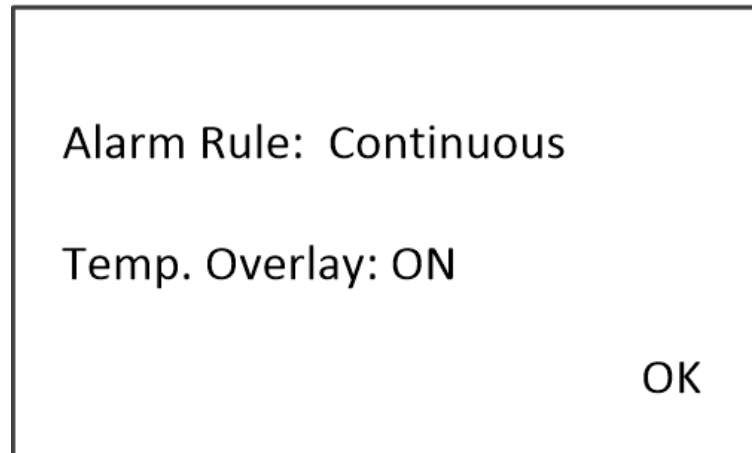

- Step 5** Press  or  to move the cursor to **OK**, and then press . Body temperature and the total number of temperature alarms are displayed on the screen. When the body temperature is normal, the words on the screen are white and the duration is 1 s. When the body temperature is abnormal, the words are red and the duration is 3 s.

Figure 4-22 Temperature Alarm



4.3.9 Setting System Parameters

Set system parameters, including zone management, network, alarm rules, infrared start-stop,

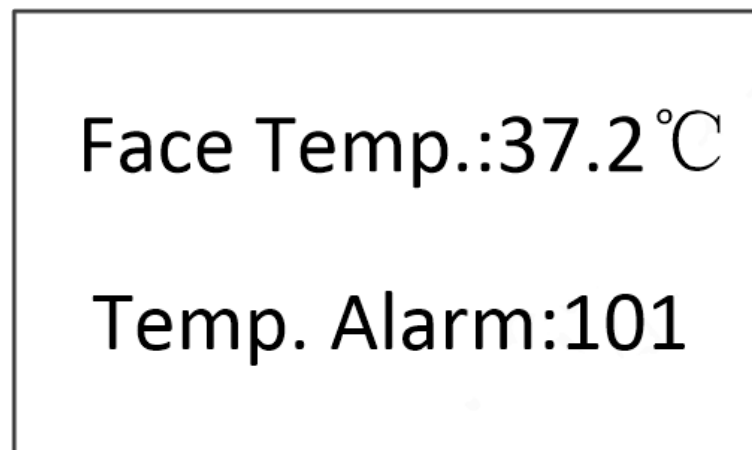
diagnosis and view device information.

.4.3.9.1 General

The detector panel can be set to 18, 12 or 6 zones.

Figure 4-23 Zones

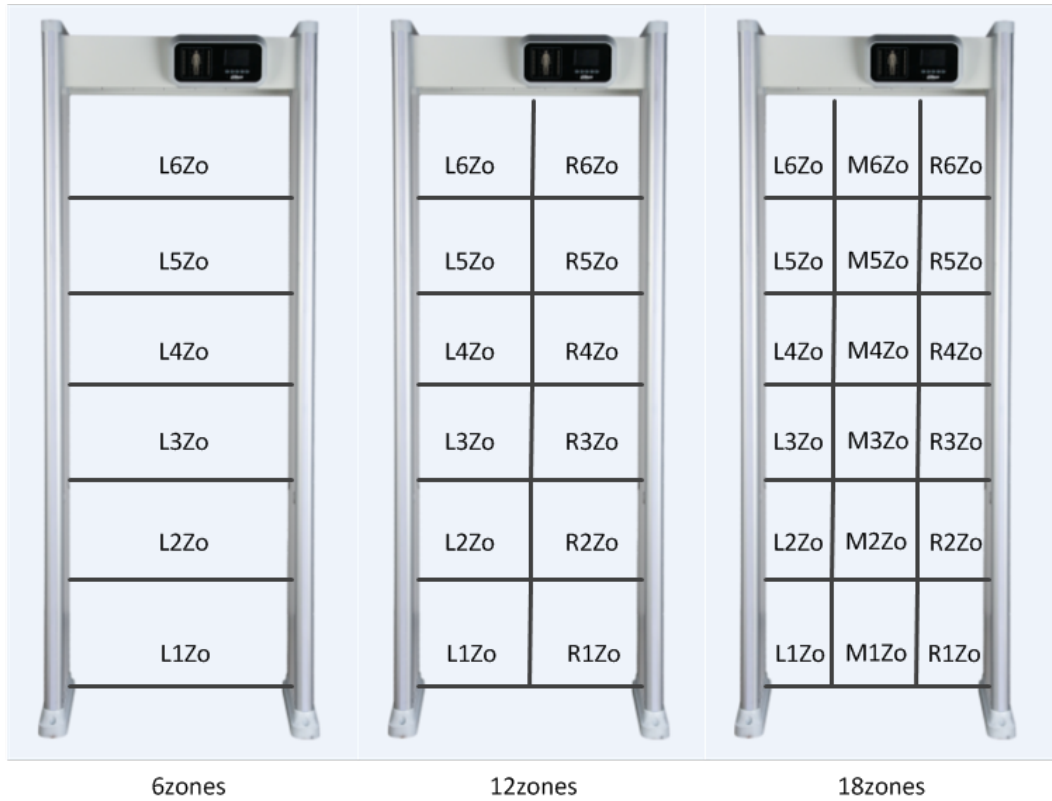

Step 1 Log in to the Detector. For details, see "4.3.1.1 Login".

Figure 4-24 System setting

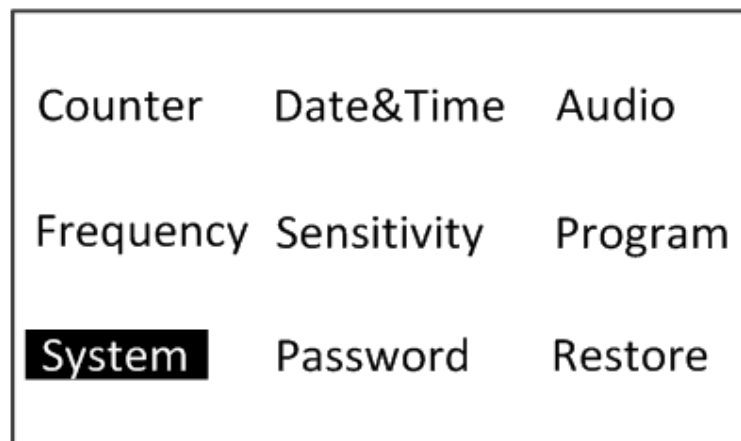

Step 2 Press ◀ or ▶ to move the cursor to **System**, and then press ⌂ to go to the system setting interface.

Figure 4-25 System setting (general)

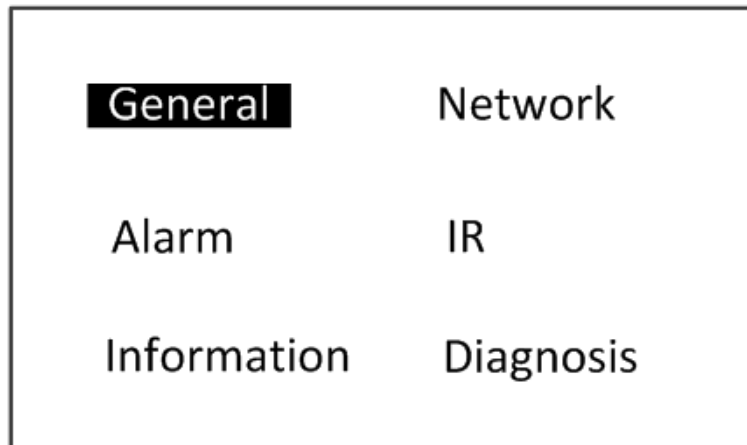

Step 3 Press ◀ or ▶ to move the cursor to **General**, and then press ⏹ to go to the general setting interface.

Figure 4-26 General setting

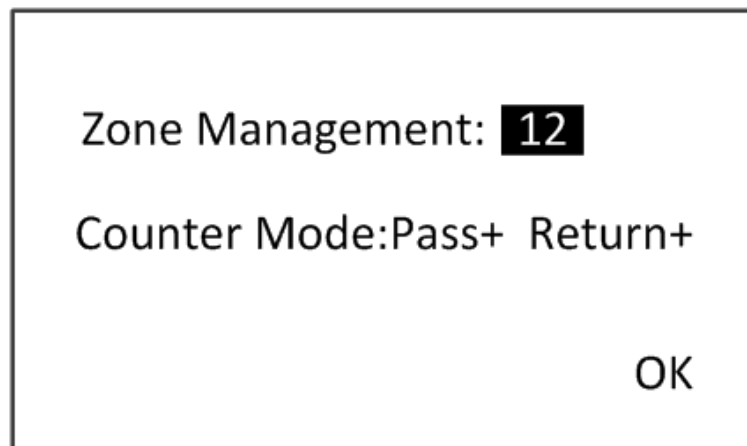



Step 4 Press ◀ or ▶ to move the cursor, and then press ⏹ to set the zone number and counter mode.

There are three counter modes:

- **Pass+ Return+**: Only one number is displayed on the screen. When people pass the detector from A to B or B to A, the number will increase.
- **Pass+ Return-**: Only one number is displayed on the screen. When people pass the detector from A to B, the number will increase; when people pass the detector from B to A, the number will decrease.
- **Pass+/Return+**: Two numbers are displayed on the screen. When people pass the detector from A to B, the pass number will increase; when people pass the detector from B to A, the return number will increase.

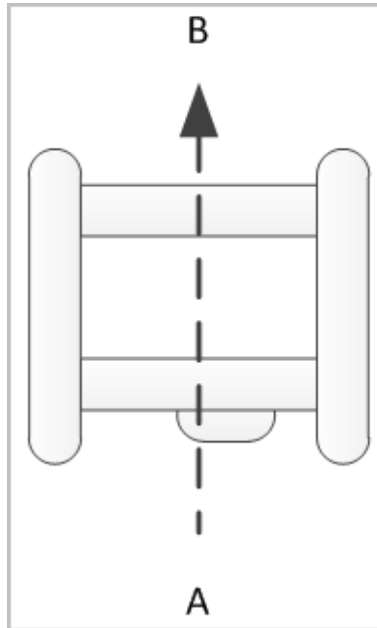
Figure 4-27 Counter modes



Step 5 Press  to move the cursor to **OK**, and then press  to save the setting.

4.3.9.2 Setting Network

Step 1 Log in to the Detector. For details, see "4.3.1.1 Login".

Figure 4-28 System setting

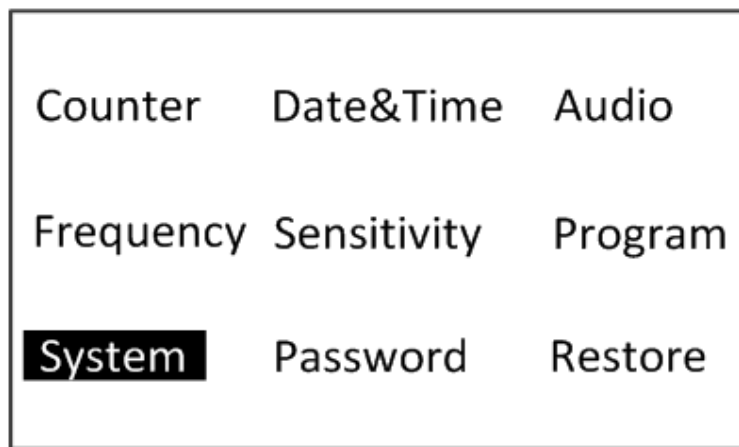



Step 2 Press  or  to move the cursor to **System**, and then press  to go to the system setting interface.

Figure 4-29 System setting (network)



Step 3 Press ◀ or ▶ to move the cursor to **Network**, and then press ⏏ to go to the network setting interface.

The IP address is 192.168.001.108 by default.

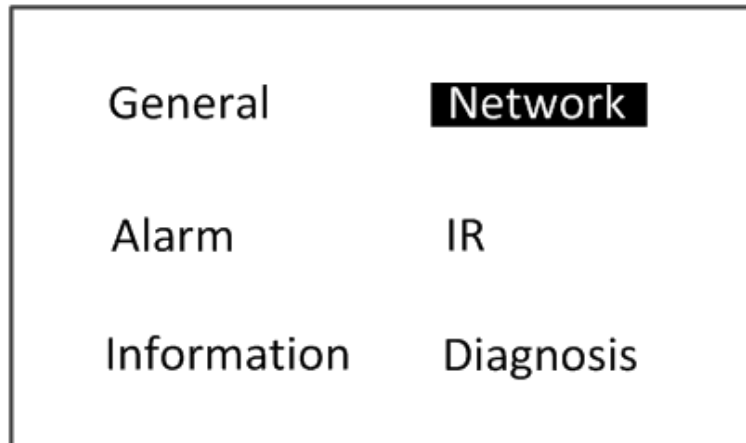
Figure 4-30 Network setting

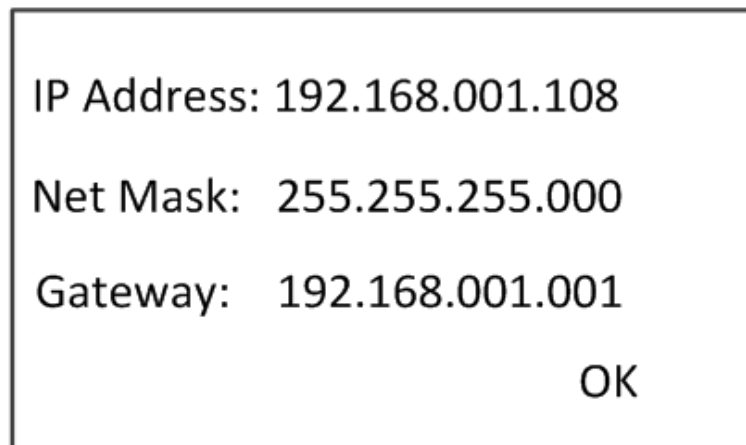

Step 4 Press ◀ or ▶ to move the cursor, and then press ⏏ to set IP address, net mask, and gateway.

Step 5 Press ▶ to move the cursor to **OK**, and then press ⏏ to save the setting.

The Device restarts after network setting, and the configuration takes effect after restating.

4.3.9.3 Setting Alarm Rules

You can set alarm rules when an alarm is triggered.

Step 1 Log in to the Detector. For details, see "4.3.1.1 Login".

Figure 4-31 System setting

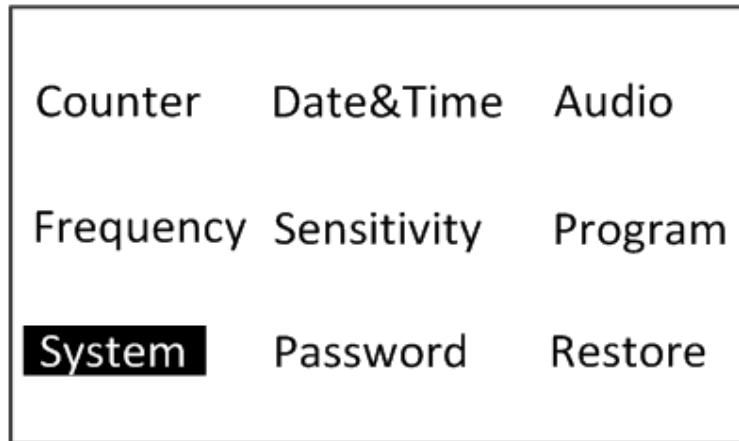

Step 2 Press ◀ or ▶ to move the cursor to **System**, and then press ⏹ to go to the system setting interface.

Figure 4-32 System setting (alarm)

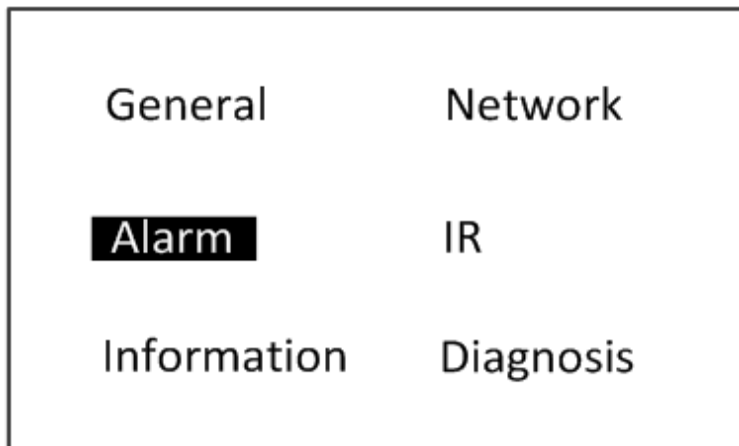

Step 3 Press ◀ or ▶ to move the cursor to **Alarm**, and then press ⏹ to go to the general setting interface.



Figure 4-33 Alarm setting



Step 4 Press ⏹ to select the rule. It is **Continuous** by default.

- **Continuous:** Alarms can be triggered in all zones.
- **Single:** Alarms can be triggered in one zone each time. For example, when an alarm is triggered in L3Zo, no alarm can be triggered in other zones.
- **Interval:** Alarms cannot be triggered in two adjacent zones (from upper to bottom) at

the same time. For example, when an alarm is triggered in L3Zo, alarms cannot be triggered in L2Zo or L4Zo, and can be performed in L1Zo, L5Zo and L6Zo.

Step 5 Press  to move the cursor to **OK**, and then press  to save the setting.

4.3.9.4 Setting Infrared Start-stop

Infrared start-stop function is designed for reducing false alarm and people counting. You can set three modes of the light alarm: Start the front group, start the rear group, and start both groups.

Step 1 Log in to the Detector. For details, see "4.3.1.1 Login".

Figure 4-34 System setting

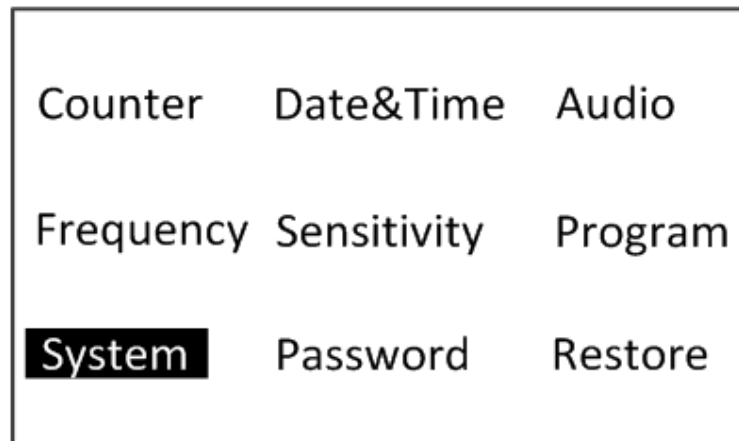

Step 2 Press  or  to move the cursor to **System**, and then press  to go to the system setting interface.

Figure 4-35 System setting (IR)

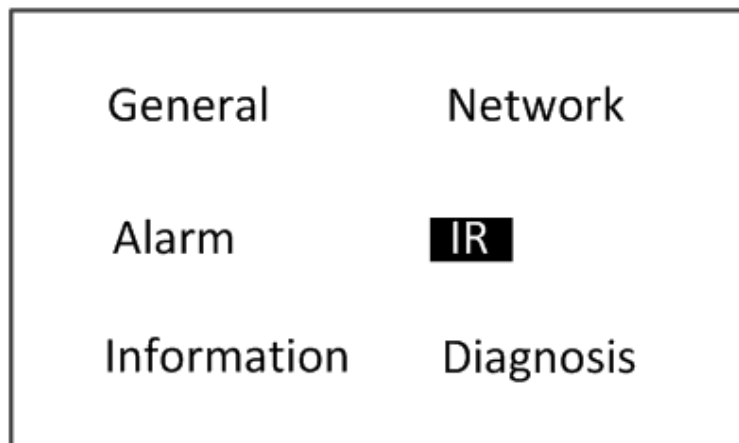

Step 3 Set alarm mode.

Press  or  to move the cursor to **IR**, and then press  to set the mode.

- **IR**: The IR mode is enabled. Metal alarm be associated with IR.
- **TEST**: The IR mode is disabled. Metal alarm is not influenced by IR.

Figure 4-36 Alarm mode setting

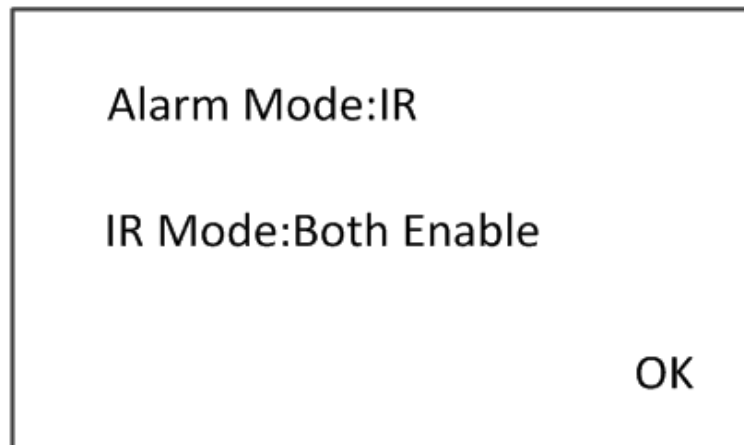



Step 4 Set the IR mode.

- **Both Enable:** The 2 groups of IR sensors will be on when an alarm is triggered, and the passing numbers of both directions are counted.
- **Both Disable:** The 2 groups of IR sensors will not be on when an alarm is triggered, and the Device enters IR test mode. The passing numbers of both directions are not counted.
- **Front Enable:** The front group of IR sensors will be on when an alarm is triggered, and only passing number of one direction is counted.
- **Rear Enable:** The rear group of IR sensors will be on when an alarm is triggered, and the passing number increases.

Figure 4-37 IR mode



Step 5 Press  to move the cursor to **OK**, and then press  to save the setting.

4.3.9.5 Viewing Device Information

You can view the device information, including version, and build time.

Step 1 Log in to the Detector. For details, see "4.3.1.1 Login".

Figure 4-38 System setting

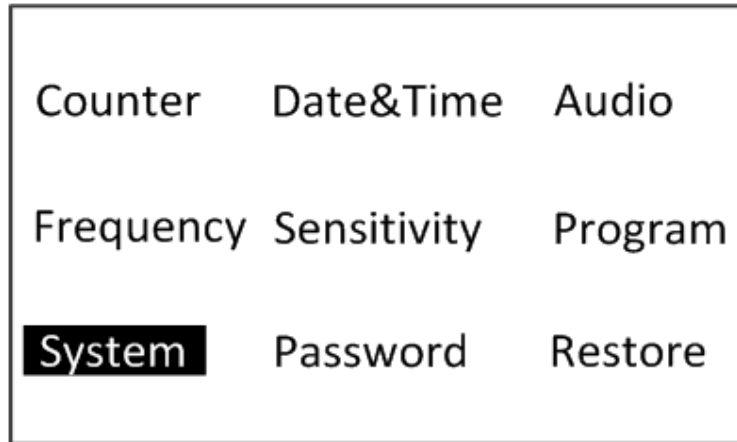

Step 2 Press ◀ or ▶ to move the cursor to **System**, and then press ⏏ to go to the information interface.

Figure 4-39 System setting (information)

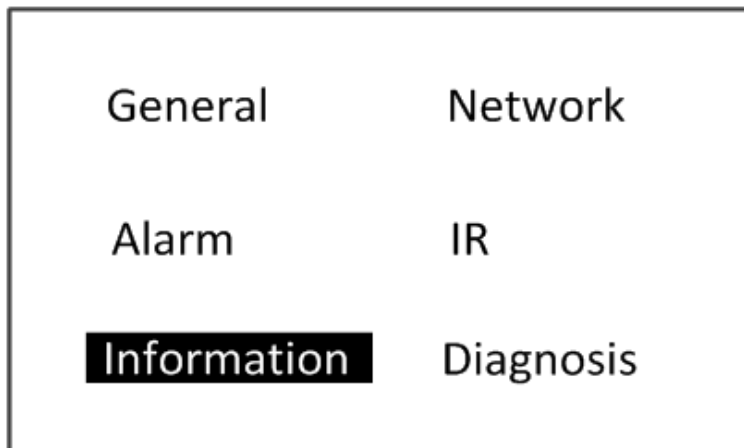

Step 3 Press ◀ or ▶ to move the cursor to **Information**, and then press ⏏ to go to the information interface.

Figure 4-40 Information

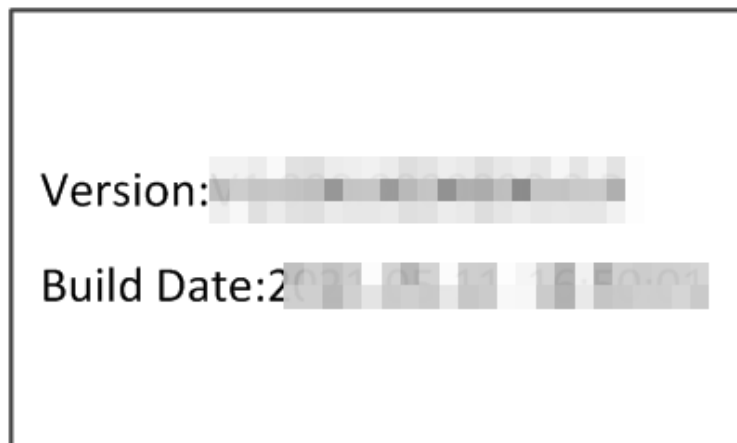

4.3.9.6 Diagnosis

Step 1 Log in to the Detector. For details, see "4.3.1.1 Login".

Figure 4-41 System setting

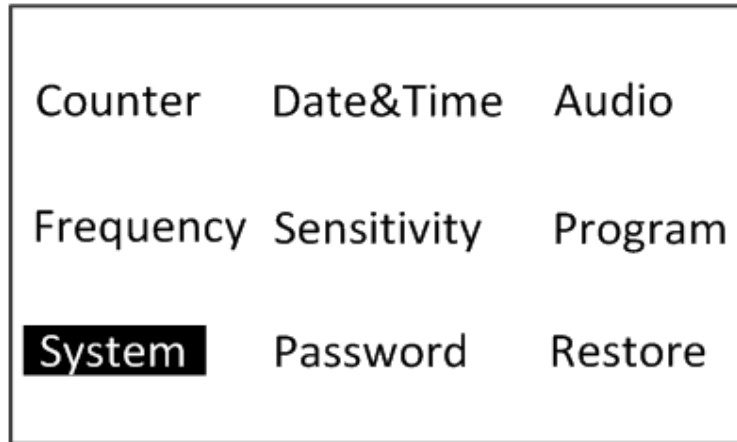

Step 2 Press ◀ or ▶ to move the cursor to **System**, and then press ⌂ to go to the information interface.

Figure 4-42 System setting (Diagnosis)

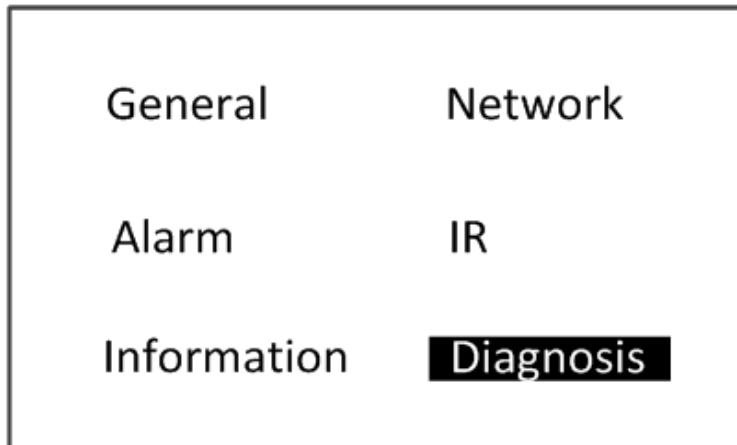

Step 3 Press ◀ or ▶ to move the cursor to **Diagnosis**, and then press ⌂ to go to the diagnosis interface.
The Device enters IR test mode.

Figure 4-43 Diagnosis

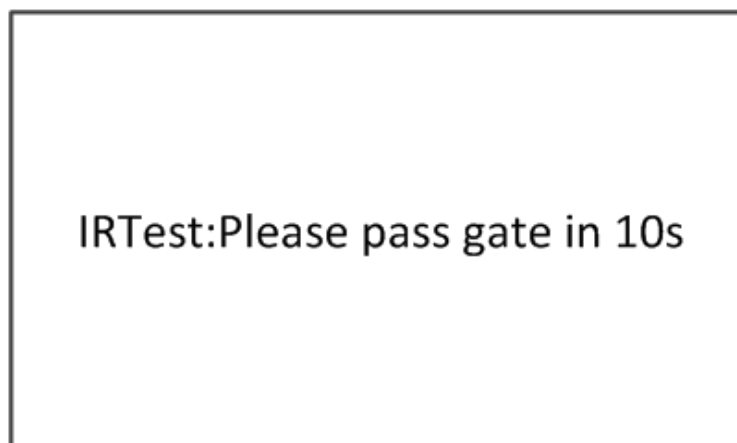

Step 4 Pass the gate in 10 s to test whether the Device works normally.

4.3.10 Viewing Alarm Record

You view the passed number and alarm times on the counter interface.

Step 1 Log in to the Detector. For details, see "4.3.1.1 Login".

Figure 4-44 Counter setting

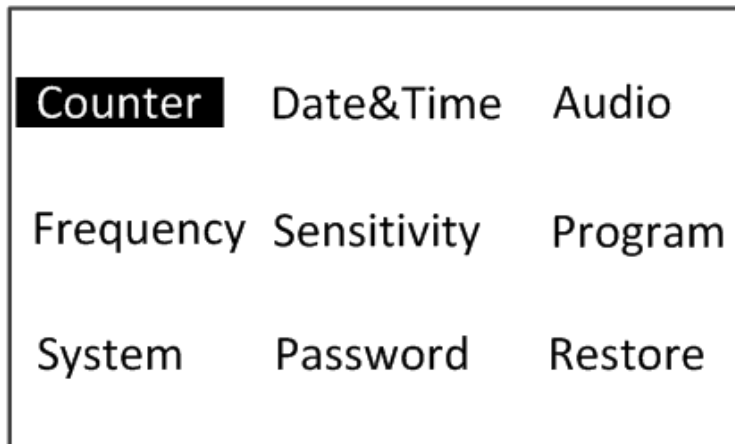

Step 2 Press or to move the cursor to **Counter**, and then press to go to the counter interface, and then you view the pass number (pass/return) and alarm times (pass/return).

Figure 4-45 Counter

Date	Passed	Alarm
06-06	0/0	0/0
06-05	0/0	0/0
06-03	0/0	0/0
06-02	0/0	0/0

Page- Page+ Exit

Related Operations

- Press or to move the cursor to **Page-** or **Page+**, and then press to turn page, and then you view the passed number and alarm times.
- Press to move the cursor to **Exit**, and then press to exit.

4.3.11 Restore

Step 1 Log in to the Detector. For details, see "4.3.1.1 Login".

Figure 4-46 Restore setting

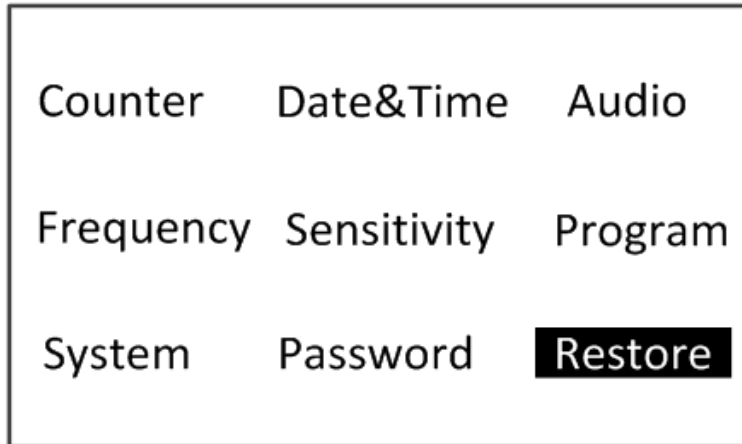

Step 2 Press ◀ or ▶ to move the cursor to **Restore**, and then press ⏹

Figure 4-47 Restore

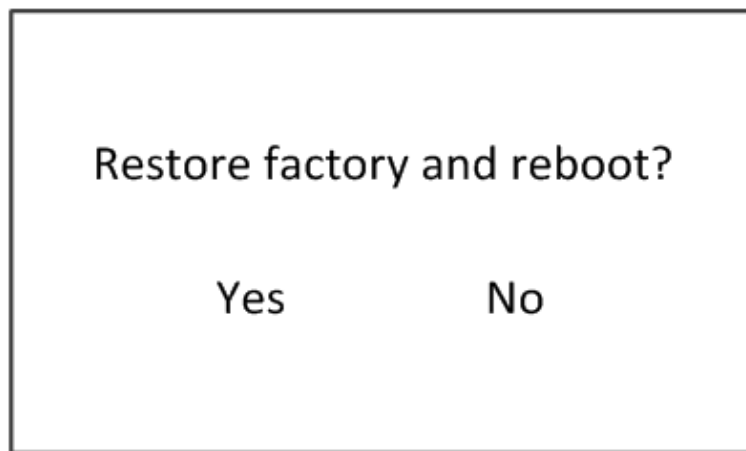

Step 3 Move the cursor to **Yes** to restore the device, and then the Detector restart. The counting records and configuration will be cleared.



You can also long press the reset button for more than 5 s to restore the Detector.

Figure 4-48 Factory default

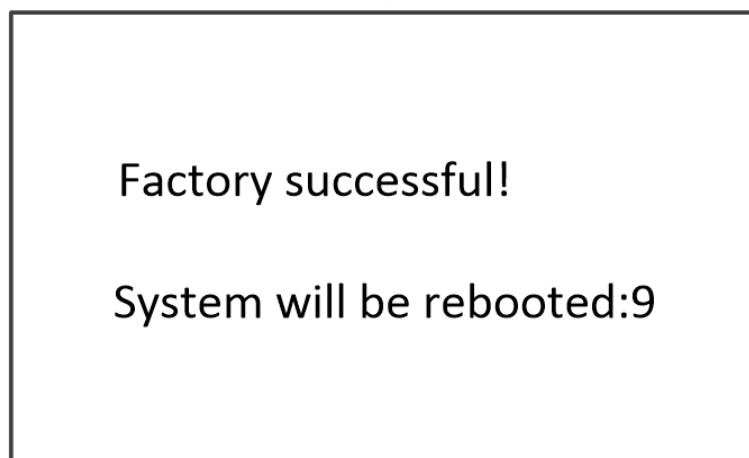

Table 4-4 Factory defaults

Parameter	Default
Alarm tone	1

Parameter	Default
Volume	8
Alarm on time	1 s
Frequency	9
Security	453
Sensitivity	120
Program	Building
Zone Management	18
Counter Mode	Pass+ Return+
Network	IP Address: 192.168.1.108 Net Mask: 255.255.255.0 Gateway: 192.168.1.1
Alarm Rule	Continuous
Alarm Mode	IR
IR Mode	Both enable

4.4 Adjusting Detection Ability

Adjust the detection ability to improve the accuracy rate of detection.



- The detection sensitivity reduces from the two sides to the middle area, so the detection ability in the middle area is the weakest.
- When detecting the detection ability with a flat metal sheet, do not make the flat panel parallel to the detector panels; otherwise the alarm will not be triggered.
- It is easier to detect the metal objects with good magnetic property than the ones with poor magnetic property.

Step 1 Select the installation scene as needed.

Step 2 Set alarm mode to test mode. If false alarms continue, adjust the frequency. Use the function of auto search frequency first. If the result is not good, adjust the frequency manually.

Step 3 Test the detection ability of each zone with a metal object. If the alarm is not triggered, turn up the sensitivity of the corresponding zone, until the alarm can be triggered.

Step 4 Set alarm mode to IR mode.

5 Detector Upgrade

You can use ConfigTool to upgrade the detector and change the password.



Go to the specified website to download ToolBox, and then install ConfigTool.

5.1 Searching for Detector

You can search for the detector on your computer with ConfigTool.

Step 1 Double-click ConfigTool.exe to open the tool.

Step 2 Click  **Modify IP** > **Search Setting**.

Figure 5-1 Search IP



The screenshot shows a 'Setting' dialog box with the following elements:

- Radio buttons: Current Segment Search, Other Segment Search
- Start IP:
- End IP:
- Username:
- Password:
- OK button:

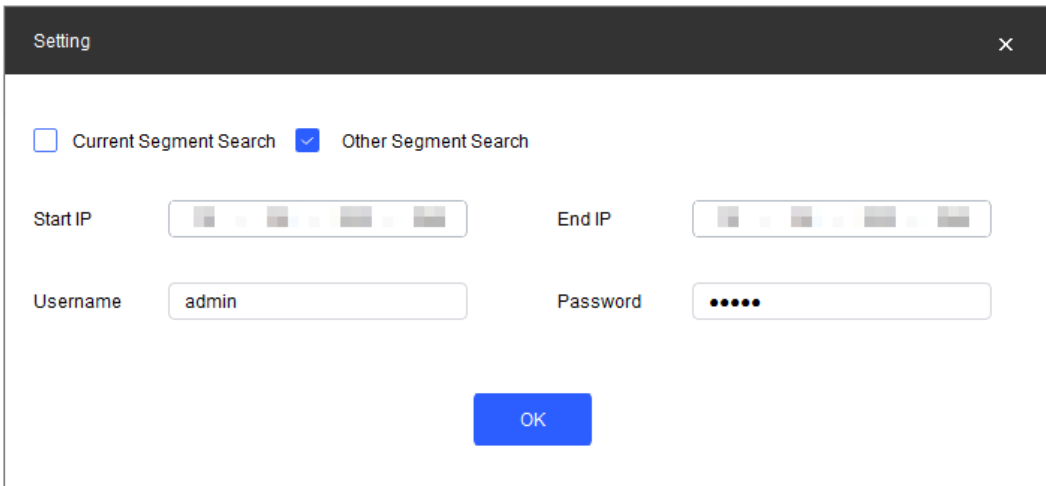
Step 3 Search for the detector.

- 1) Select **Other Segment Search**.
- 2) Enter the IP address in the **Start IP** box and the **End IP** box respectively.
- 3) Enter the username and the password, which is both admin by default.

Step 4 Click **OK**.

Results are displayed on the **Modify IP** page.

Figure 5-2 Search result

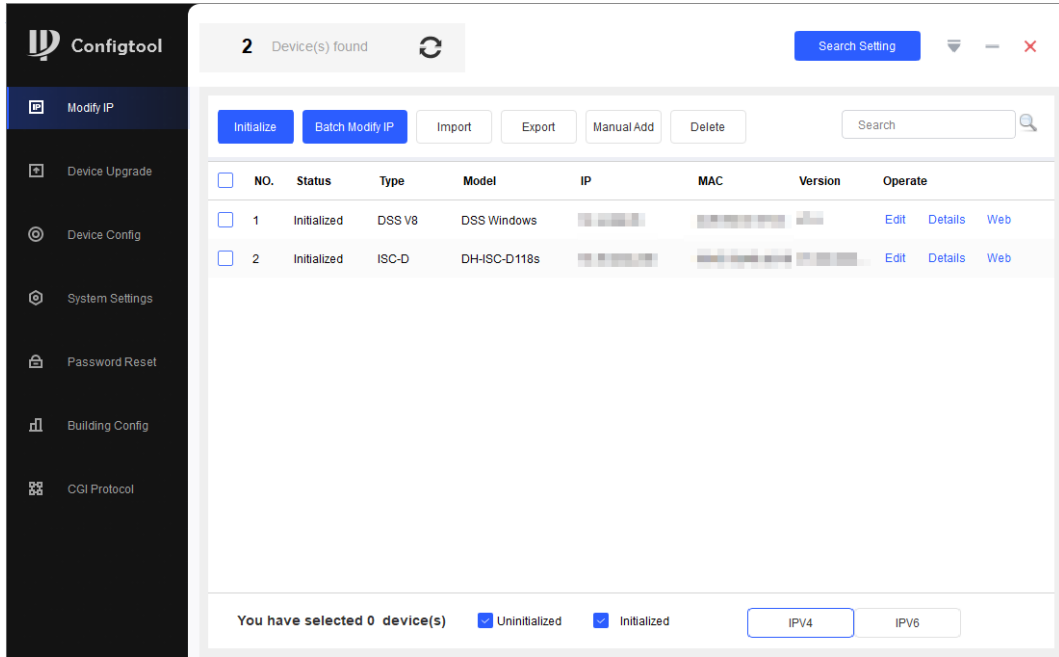

Related Operations

Click  to refresh the device list.

5.2 Upgrading Detector

You can upgrade the detector on your computer with ConfigTool.

Step 1 Click  **Device Upgrade**.

Figure 5-3 Upgrade

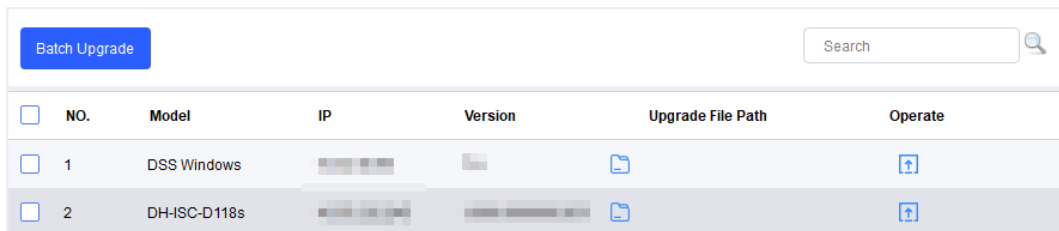

Step 2 Click , and then select the file that needs to be upgraded and click **Open**.



If the device is not on the device list, try to search for it again. For details, see "5.1 Searching for Detector".

Step 3 Click  to start upgrading.

After the upgrade is complete, a **Notice** dialog box will be displayed indicating the detector will be restarted. Then the detector restarts automatically.

5.3 Changing Password

You can change the detector login password on your computer with ConfigTool.



- The password is admin by default.
- If you forget the password, press the reset button for more than 5 s to reset the password. Contact our overseas service center or service hotline if you need any help.



Step 1 Click  **System Settings** > **Password**.

Figure 5-4 Change password



Step 2 Click  to expand the device list, and then select one or multiple detectors.

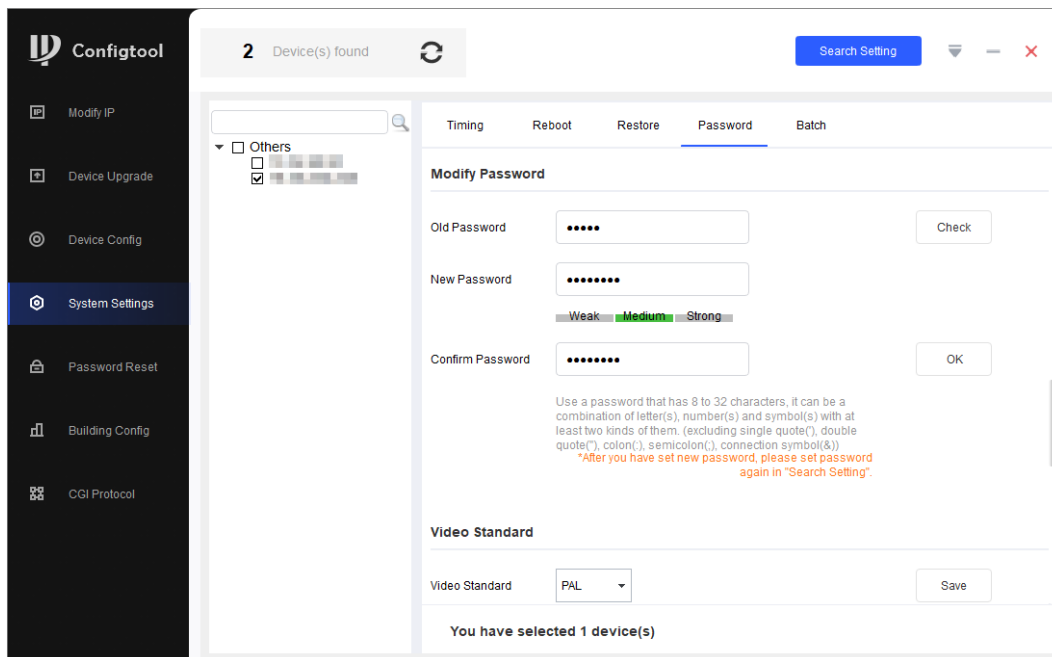

If you select multiple detectors, the login passwords must be the same.

Step 3 Set the password.



To make sure that the old password is correct, you can click **Check** to verify.

Step 4 Click **OK**.

6 FAQ

1. **Deal with the replaced spare parts.**

Contact our overseas service center to check whether you need to send back the spare parts.

2. **The Device cannot start.**

- a. Check whether the power is switched on.
- b. Check whether the host box is powered on.
- c. Check whether the power cable is loose or broken.
- d. Replace the host box.

3. **The screen cannot display content after the Device starts.**

- a. Check whether the power is switched on.
- b. Check whether the host box is powered on.
- c. Check whether the cable between the detector panel and the host is connected well.
- d. Replace the host box.

4. **The passed people cannot be counted. (The indicator light cannot work normally, or the Device might alarm without people passing.)**

- a. Check whether the IR mode is both enabled.; if not, select the mode to **Both Enabled**.
- b. The Device enters diagnosis menu, and check whether the two groups of IR lights work normally.
- c. Remove the host and test it with the detector panels that can work normally. If the problem still cannot be solved, replace the host box; otherwise, replace detector panels.

5. **There are false alarms.**

- a. Check whether the environment influences the detection rate of the Device. For example, check whether there is direct light to the infrared sensors, and whether there are large metals within 1 meter's range.
- b. Adjust the frequency. Use the function of auto search frequency first. If the result is not good, adjust the frequency manually. To set the suitable frequency quickly, we recommend 3 levels for an adjustment. For example, when the current frequency is 3, adjust it to 6, and then check whether there are false alarms; if yes, adjust it to 9, and then check whether there are false alarms again. Repeat the operation until there is no false alarm..
- c. Adjust the sensitivity or security level lower.
- d. Replace the host detector for testing.
- e. If the problem still cannot be solved, replace the detector panels.

6. **An alarm is not triggered when carry-on metal is passing.**

- a. Adjust the sensitivity of each zone higher.
- b. If the alarm is not triggered with the highest sensitivity or security level , replace the host detector for testing.
- c. Check the alarm duration, make sure the value is not 0.
- d. If the problem still cannot be solved, replace detector panels.

7. **Alarm lights are not on.**

- a. Check whether the power supplies of host and detector panel are normal.
- b. Check whether the ribbon cables of the alarm light are loose or broken.
- c. Check the alarm duration, make sure the value is not 0.
- d. If the problem still cannot be solved, replace the host detector.

8. **No alarm is triggered in zones.**

- a. Adjust the sensitivity value higher

- b. Replace the host detector.
 - c. If the problem still cannot be solved, replace detector panels.
9. **No alarm sound.**
- a. Check whether the alarm sound is disabled.
 - b. Check the alarm duration, make sure the value is not 0.
 - c. Replace the speaker.
10. **There are big differences among the zone sensitivity values.**
- a. Configure the sensitivity values according to the actual situation of each zone.
 - b. If the problem still cannot be solved, replace detector panels.
11. **Buttons on the host box cannot work normally.**
- a. Check whether buttons are in good contact.
 - b. If buttons are in good contact, replace the mainboard.
12. **The remote control cannot work normally.**
- a. Replace the batteries.
 - b. Check whether the buttons work normally.
 - c. Check whether the IR sensor on the host box is blocked or interfered.
13. **The network of host box is not connected successfully.**
- a. Check whether the network cable is connected well, and whether the Device IP and the default IP are in the same network segment.
 - b. Check whether the connection board and cable are connected well, or whether they are broken.
 - c. Install the mainboard program again.
 - d. If the problem still cannot be solved, replace the related accessories.
14. **Forget Password.**
- a. Long press the reset button for more than 5 s to reset the password.
 - b. If failed, contact our overseas service center or service hotline.
15. **Fail to connect the detector to platforms.**
- a. Check whether the detector connects to the same network segment as the platform.
 - b. Check whether the username and password are correct.
 - c. If you forget the password, long press the reset button to restore the detector.

Appendix 1 Cybersecurity Recommendations

Mandatory actions to be taken for basic equipment network security:

1. Use Strong Passwords

Please refer to the following suggestions to set passwords:

- The length should not be less than 8 characters.
- Include at least two types of characters; character types include upper and lower case letters, numbers and symbols.
- Do not contain the account name or the account name in reverse order.
- Do not use continuous characters, such as 123, abc, etc.
- Do not use overlapped characters, such as 111, aaa, etc.

2. Update Firmware and Client Software in Time

- According to the standard procedure in Tech-industry, we recommend to keep your equipment (such as NVR, DVR, IP camera, etc.) firmware up-to-date to ensure the system is equipped with the latest security patches and fixes. When the equipment is connected to the public network, it is recommended to enable the “auto-check for updates” function to obtain timely information of firmware updates released by the manufacturer.
- We suggest that you download and use the latest version of client software.

"Nice to have" recommendations to improve your equipment network security:

1. Physical Protection

We suggest that you perform physical protection to equipment, especially storage devices. For example, place the equipment in a special computer room and cabinet, and implement well-done access control permission and key management to prevent unauthorized personnel from carrying out physical contacts such as damaging hardware, unauthorized connection of removable equipment (such as USB flash disk, serial port), etc.

2. Change Passwords Regularly

We suggest that you change passwords regularly to reduce the risk of being guessed or cracked.

3. Set and Update Passwords Reset Information Timely

The device supports password reset function. Please set up related information for password reset in time, including the end user’s mailbox and password protection questions. If the information changes, please modify it in time. When setting password protection questions, it is suggested not to use those that can be easily guessed.

4. Enable Account Lock

The account lock feature is enabled by default, and we recommend you to keep it on to guarantee the account security. If an attacker attempts to log in with the wrong password several times, the corresponding account and the source IP address will be locked.

5. Change Default HTTP and Other Service Ports

We suggest you to change default HTTP and other service ports into any set of numbers between 1024–65535, reducing the risk of outsiders being able to guess which ports you are using.

6. Enable HTTPS

We suggest you to enable HTTPS, so that you visit Web service through a secure communication channel.

7. MAC Address Binding

We recommend you to bind the IP and MAC address of the gateway to the equipment, thus reducing the risk of ARP spoofing.

8. Assign Accounts and Privileges Reasonably

According to business and management requirements, reasonably add users and assign a minimum set of permissions to them.

9. **Disable Unnecessary Services and Choose Secure Modes**

If not needed, it is recommended to turn off some services such as SNMP, SMTP, UPnP, etc., to reduce risks.

If necessary, it is highly recommended that you use safe modes, including but not limited to the following services:

- SNMP: Choose SNMP v3, and set up strong encryption passwords and authentication passwords.
- SMTP: Choose TLS to access mailbox server.
- FTP: Choose SFTP, and set up strong passwords.
- AP hotspot: Choose WPA2-PSK encryption mode, and set up strong passwords.

10. **Audio and Video Encrypted Transmission**

If your audio and video data contents are very important or sensitive, we recommend that you use encrypted transmission function, to reduce the risk of audio and video data being stolen during transmission.

Reminder: encrypted transmission will cause some loss in transmission efficiency.

11. **Secure Auditing**

- Check online users: we suggest that you check online users regularly to see if the device is logged in without authorization.
- Check equipment log: By viewing the logs, you can know the IP addresses that were used to log in to your devices and their key operations.

12. **Network Log**

Due to the limited storage capacity of the equipment, the stored log is limited. If you need to save the log for a long time, it is recommended that you enable the network log function to ensure that the critical logs are synchronized to the network log server for tracing.

13. **Construct a Safe Network Environment**

In order to better ensure the safety of equipment and reduce potential cyber risks, we recommend:

- Disable the port mapping function of the router to avoid direct access to the intranet devices from external network.
- The network should be partitioned and isolated according to the actual network needs. If there are no communication requirements between two sub networks, it is suggested to use VLAN, network GAP and other technologies to partition the network, so as to achieve the network isolation effect.
- Establish the 802.1x access authentication system to reduce the risk of unauthorized access to private networks.
- Enable IP/MAC address filtering function to limit the range of hosts allowed to access the device.