



EN 54-20
EN 54-17



0832
24

0832-UKCA-CPR-F1811



991n/01



2831
24
2831-CPR-F4883

FA100

Aspirating smoke
detector

INSTALLATION AND
PROGRAMMING MANUAL



FA | 100

inim®

Warranty

Inim Electronics S.r.l. warrants that this product shall be free of defects in material and workmanship for a period of 24 months from the date of production.

In consideration of the fact that Inim Electronics does not install directly the products here indicated, and due to the possibility they may be used with other products not manufactured by Inim Electronics, Inim Electronics cannot guarantee the performance of the security installation. Seller obligation and liability under this warranty are expressly limited to repairing or replacing, at seller's option, any product not meeting its stated specifications. In no case can Inim Electronics be held responsible or liable by the buyer or any other person for any loss or damage, direct or indirect, consequential or incidental, including, without limitation, any damages for lost profits, stolen goods or claims by any other party caused by defective products or otherwise arising from the incorrect or otherwise improper installation or use of these products.

This warranty applies only to defects in parts and workmanship relating to normal use. It does not cover misuse or neglect, damage caused by fire, flood, wind, lightning, vandalism or wear and tear.

Inim Electronics shall, at its option, repair or replace any defective products. Improper use, that is, use for purposes other than those mentioned herein will void this warranty. For further details regarding this warranty contact the authorized dealer.

**Limited
Warranty**

Inim Electronics S.r.l. shall not be liable for any damage caused by improper use of this product.

The installation and use of the products indicated herein must be carried out by authorized persons only. Moreover, the installation procedure must be carried out in full respect of the instructions provided in this manual.

Table of contents

Chapter 1 General information	4
1.1 Manufacturer's details	4
1.2 Detection classes	4
1.3 Access levels	4
1.4 Manuals	5
1.5 About this manual	5
1.6 Copyright	5
1.7 Terminology	5
1.7.1 Graphic conventions	5
1.8 CE Mark	6
1.9 Directive 2014/53/EU	6
1.10 Documents for the users	7
1.11 Safeguard instructions	7
Chapter 2 Description of FA100	8
2.1 Description of parts	9
2.1.1 Description of the PCB	11
2.2 Technical specifications of FA100	11
2.3 Connection terminals	12
2.4 Buttons	13
2.5 Service mode, disablement and bypass status	14
Chapter 3 Feedback signals provided by FA100	15
3.1 LED signalling	15
3.2 Buzzer signalling	16
Chapter 4 LCD display	17
4.1 Main screen	17
4.2 Warning screens	17
Chapter 5 Access to user / installer menu	19
5.1 Settings	19
5.2 Service	21
5.3 View	21
Chapter 6 Connections	23
6.1 Power supply	23
6.2 Programmable inputs	24
6.3 Programmable outputs	25
6.4 Connection to a fire-control panel	25
Chapter 7 FA/STUDIO software	28
Chapter 8 Plant engineering	30
8.1 Project	31
8.1.1 Use of a second FAD100	33
8.2 Installation	33
8.2.1 Installation of a second FAD100	34
8.2.2 Mounting the sampling pipes	35
8.2.3 Installation of the 504F075ABS filter	35
8.2.4 Sampling holes	36
8.2.5 Inspection and verification	36
8.3 Commissioning	37
8.3.1 Programming	37
8.3.2 Auto-calibration of flow	37
8.3.3 Functional verification	37
8.4 Scheduled service	38
8.4.1 Cleaning of the FAD100FILTER filter meshes	38
Appendix A Accessories	40
Appendix B Pre-calculated installations	43

Chapter 1 General information

1.1 Manufacturer's details

Manufacturer: Inim Electronics S.r.l.
Production plant: Centobuchi, via Dei Lavoratori 10
 63076 Montepandone (AP), Italy
Tel.: +39 0735 705007
Fax: +39 0735 734912
E-mail: info@inim.it
Web: www.inim.it

The persons authorized by the manufacturer to repair or replace the parts of this system have authorization to work only on devices marketed under the brand Inim Electronics.

1.2 Detection classes

The EN 54-20 standard provides a classification of aspirating smoke detectors based on detection sensitivity.

The class of the detector must be chosen to suit the project requirements and the characteristics of the environments to be monitored.

Class A

Very high sensitivity detection systems that allow the detection of extremely diluted smoke in the air.

To be used in very clean environments where prompt detection is essential, such as, for example, "white rooms".

Class B

Detection systems with advanced sensitivity that allow early detection of smoke.

To be used in environments where there are valuable or particularly vulnerable or critical assets such as, for example, electronic devices, server rooms, etc.

Class C

Detection systems with normal sensitivity that allow smoke detection in a similar way to traditional point detectors.

To be used in environments that do not present any specific criticalities.

1.3 Access levels

FA100 provides the following access levels for the user:

Level	permissions
Public access 1	Visualization of the LED signals, LED signals test, visualization of the information provided on the initial display screen.
User 2	Access to the reading of diagnostic information, fault details, events log and programming version.
Installer 3	The same permissions as the user, plus the possibility to change some programming options: <ul style="list-style-type: none"> • Sensitivity • Sensitivity class (A, B, C) • Aspirator speed • Nominal flow rate • Fault thresholds By means of the FA/STUDIO programming software, change all the programming options.
Maintenance 4	Firmware upgrade

A PIN code can be assigned to each user. The characteristics of the PIN code depend on the access level.

1.4 Manuals

Instructions manual

Installation and programming manual

(this manual)

Software and programming manual

The manuals which are not supplied with the apparatus can be ordered, making reference to their respective codes, or downloaded from www.inim.it.

The guide, supplied with the package content, provides all the instructions necessary for fast installation of the FA100.

The installation manual contains the technical specifications of all the system components and the instructions for their installation, including instructions with wiring diagrams for the various modules.

It also contains the instructions for system commissioning

It is the responsibility of the installer to follow all the manufacturer's instructions in order to ensure proper functioning of the system and, at the same time, to comply with all the warnings relating to the active and passive security of the installation.

The FA/STUDIO software and programming manual contains the description of the software and the instructions for its installation and use.

It also contains the instructions for the configuration and programming of the FA100 system, as well as the descriptions of all the parameters and options.

It is the responsibility of the person who programs the FA100 system to follow the instructions carefully and to ensure they have complete knowledge of the software in order to proceed swiftly and properly with the configuration and programming procedures.

1.5 About this manual

Manual code: DCMIINE0FA100

Revision: 110

1.6 Copyright

The information contained in this document is the sole property of Inim Electronics S.r.l.. Copying, reprinting or modification of this document, in part or as a whole, is not permitted without prior authorization in writing from Inim Electronics S.r.l.. All rights reserved.

1.7 Terminology

Panel, control panel, device

Refer to the main supervisory unit and any constituent parts of the security system device.

Left, Right, Behind, Above, Below

Refer to the directions as perceived by the operator when directly in front of the mounted device.

Qualified personnel

Persons whose training, expertise and knowledge of the products and laws regarding security systems, are able to create, in accordance with the requirements of the purchaser, the most suitable solution for the protected premises.

Select

Click on a specific item on the interface (drop-down menu, options box, graphic object, etc.).

Press

Click-on/push a video button/key on a keypad or screen.

1.7.1 Graphic conventions

Note

The notes contain important information relating to the text.

Attention!



The DANGER warnings indicate that total or partial disregard of the procedure could injure the operator or persons in the vicinity.

EN54

Such indications indicate that the information and instructions refer to European standards.

1.8**CE Mark**

These products comply with requirements stated by standards listed here below in compliance with Regulation (EU) No. 305/2011.

 2831		 0832	
INIM Electronics s.r.l. Via Dei Laboratori 10 - Fraz. Centobuchi 63076 Monteprandone (AP) - Italy			
24 2831-CPR-F4883		24 0832-UKCA-CPR-F1811	
EN54-20:2006 EN54-17:2005 FA100 Single (expandable to two) pipe aspirating smoke detector for fire detection and fire alarm systems installed in buildings Class: A, B and C			
Essential characteristics EN54-20		Performance	
Nominal activation conditions/sensitivity, response delay (response time) and performance under fire conditions		PASS	
Operating reliability		PASS	
Tolerance to supply voltage		PASS	
Durability of operating reliability:	Temperature resistance	PASS	
	Vibration resistance	PASS	
	Electrical stability	PASS	
	Humidity resistance	PASS	
	Corrosion resistance	PASS	
Essential characteristics EN54-17		Performance	
Performance under fire conditions		PASS	
Operating reliability		PASS	
Durability of operating reliability:	Temperature resistance	PASS	
	Vibration resistance	PASS	
	Electrical stability	PASS	
	Humidity resistance	PASS	
	Corrosion resistance	PASS	
Additional information according to EN 54-20			
For the information required by point 5.12, see document "Technical specification - FA100 Firmware" held by manufacturer			
Additional information according to EN 54-17			
For the information required by point 4.8, see data contained in this manual			

1.9**Directive 2014/53/EU**

Hereby, Inim Electronics S.r.l. declares that the FA100 and the following optional modules are in compliance with the essential requirements and other relevant provisions of Directive 2014/53/EU.

Following paragraph explains how to download the complete Declaration of Conformity.

This product may be used in all EU Countries.

1.10 Documents for the users

Declarations of Performance, Declarations of Conformity and Certificates concerning to Inim Electronics S.r.l. products may be downloaded free of charge from the web address www.inim.it, getting access to Extended Access and then selecting "Certifications" or requested to the e-mail address info@inim.it or requested by ordinary mail to the address shown in this document.

Manuals may be downloaded free of charge from the web address www.inim.it, getting access to the reserved area, after the login, and then to the section of each product.

1.11 Safeguard instructions

The following symbol shown on the product and/or on its packaging indicates to refer to this manual for further information on the electrical safety of the product.

  **EN IEC 62368-1**

Terminal type	LOOP +/-	ES1, PS1
	PRIM +/-, AUX +/-	ES1, PS2
	+ 24	ES1, PS1
	I/O1, I/O2, I/O3, I/O4	ES1, PS1
	NC, C, NO (R1, R2, R3, R4, R5, R6)	ES1, PS2
	USB	ES1, PS1

Chapter 2 Description of FA100



FA100 is an aspirating smoke detector equipped with two removable and independent sampling chambers.

The device is equipped with an aspirator, common to both detector modules, which draws the air from the rooms monitored through two distinct piping networks.

The product is supplied with only one detection module; a second one can be purchased separately.

Each of the detector modules can be configured independently in class A, B or C (see "Detection Classes") and can support a maximum number of sampling holes equal to 8, 18 and 51 respectively.

The detector modules are based on a dual light technology that uses two distinct light sources (infrared and blue) capable of evaluating the dimensions of the aspirated particulate and of providing a prompt response in outbreaks of fire as well as a high rejection of false alarms caused by dust or mists.

Each of the detector modules is capable of measuring the flow rate of the aspirated air and of signalling a fault if this deviates from the value set when activating the system (clogged sampling holes or breaks in the sampling duct).

FA100 can be connected to Inim Electronics addressable fire control panels by connecting it directly to the loop (the power supply voltage must be supplied separately) thus transferring all the signals and controls to the control panel, or it can be connected to any conventional control panel thanks to its relay outputs and I/O terminals.

Main features

- 2 detector modules with independent smoke and flow detectors
- optical smoke detection with dual light technology: infrared and blue
- Classification A, B and C in accordance with EN 54-20
- programmable sensitivity from 235 to 20000 · 10⁻⁵ dB/m
- one detection module supplied and one optional
- single aspiration fan
- 6 dual switching relays, free contacts (not certified in accordance with EN 54-18)
- 4 programmable inputs / open collector outputs (not certified in accordance with EN 54-18)
- optional FA100-WIFI Wi-Fi module for communication with a PC for programming and diagnostics
- LCD graphic display

Functions

- Connection to the loop of an addressable analogue switch of the Inim Electronics
- Connection to a conventional control panel (via a fault relay, an alarm relay, a programmable input and suitable balancing resistors)
- Levels of detection for warning and smoke alarm programmable and independent for each aspiration pipe
- Automatic rearm: if enabled, the warning and alarm status are reset when the smoke level drops below the programmed thresholds
- Non-volatile memory for the recording of the trend of the smoke level, air flow and air temperature for each individual aspiration pipe

- Memory storage capacity for at least two months of detection data with 1-minute sampling
- Management of summer/winter time

2.1 Description of parts

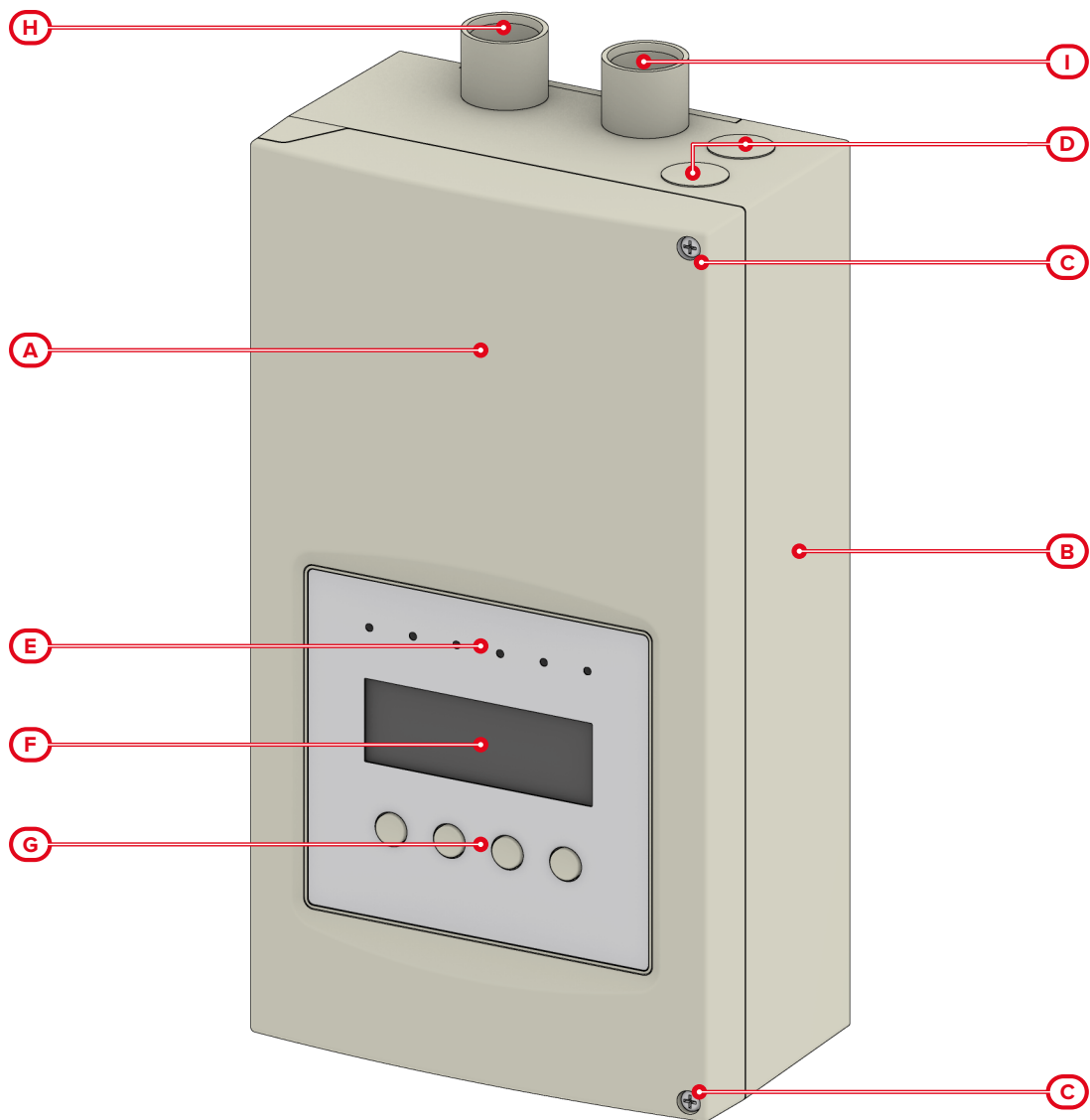

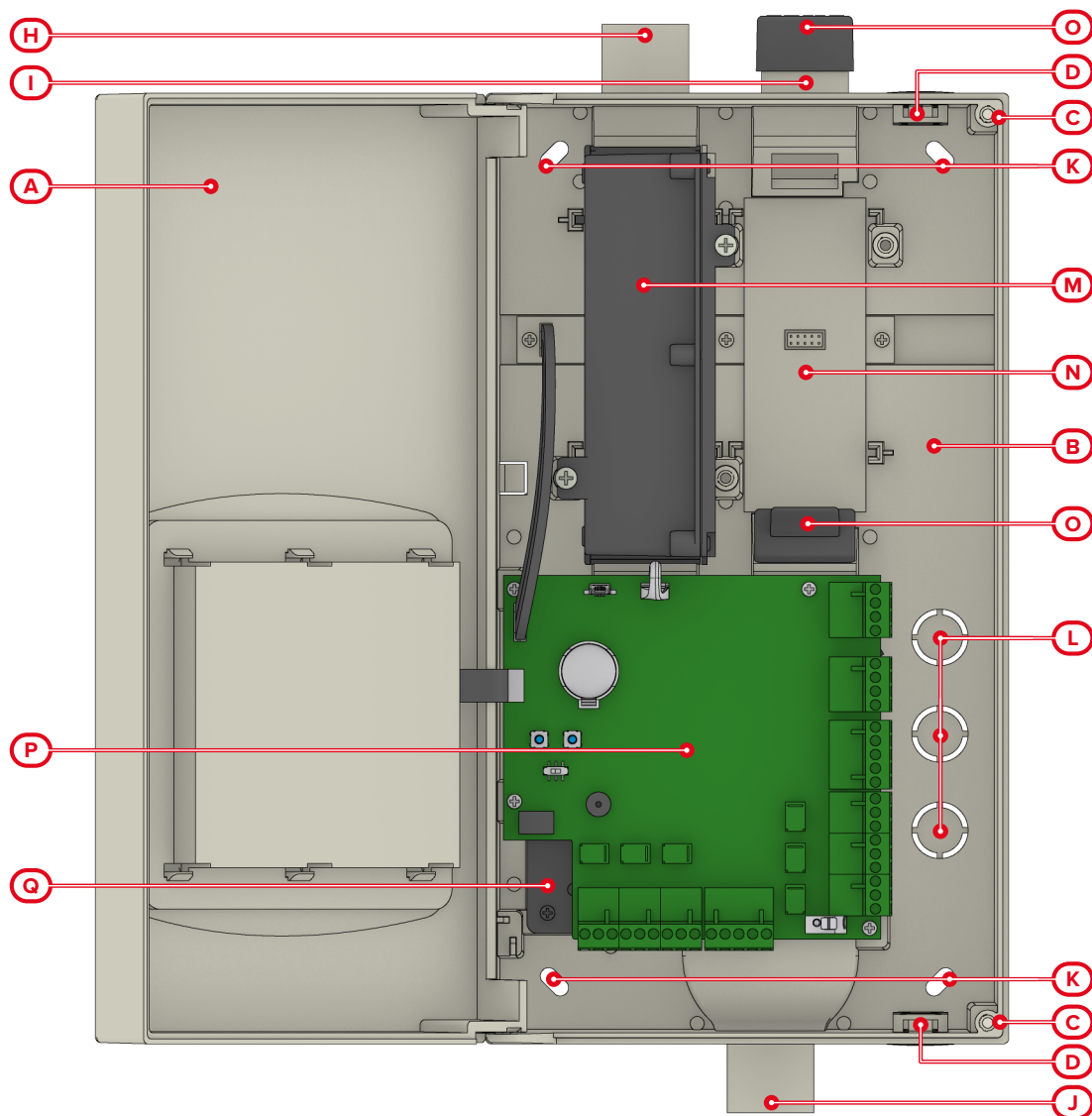

[A]	Cover
[B]	Back
[C]	Cover screws
[D]	Cable entry
[E]	Signalling LEDs
[F]	LCD display
[G]	Multifunction buttons
[H]	Aspiration pipe 1 attachment fitting
[I]	Aspiration pipe 2 attachment fitting
[J]	Exhaust pipe attachment fitting
[K]	Mounting screw location
[L]	Pre-cut holes for cable entry
[M]	FAD100, Detector 1 module (supplied)
[N]	Compartment for detector module 2 (optional)
[O]	Removable caps
[P]	Mother board
[Q]	Aspirator

Inside the package

FA100 comes with:

- USB cable for programming purposes
- 2 100Ohm resistors
- 4 3k90hm resistors
- 4 1kOhm resistors
- installation guide

2.1.1 Description of the PCB

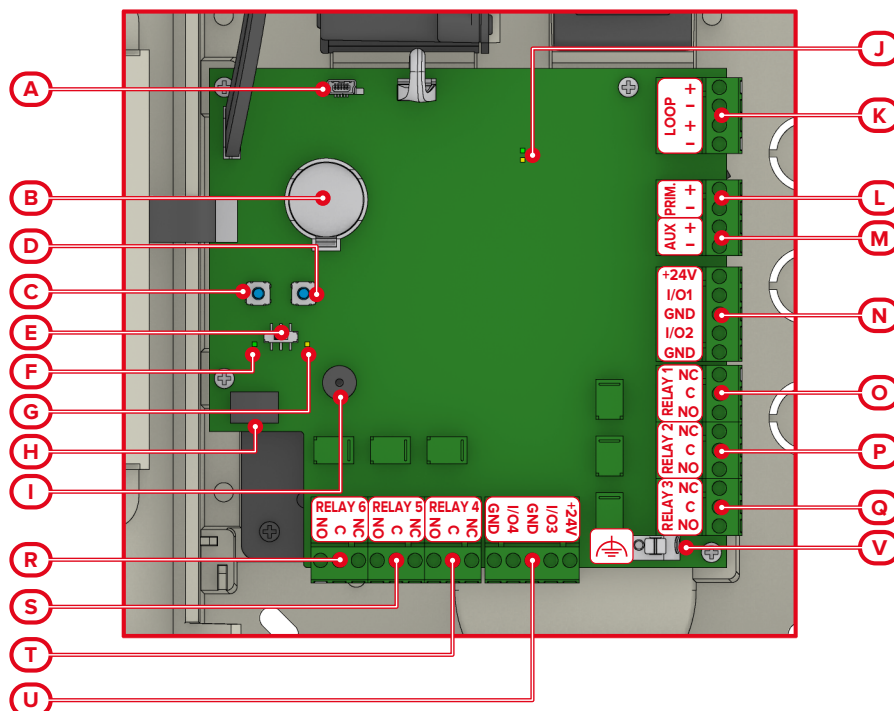

[A]	mini-USB connector	[K]	Loop terminals
[B]	CR2032 battery	[L]	Primary power-supply terminals
[C]	Button to reset default settings (factory settings)	[M]	Ancillary power-supply terminals
[D]	Restart button	[N]	I/O1, I/O2 terminals
[E]	RUN/SERVICE switch	[O]	Relay terminals 1
[F]	RUN LED	[P]	Relay terminals 2
[G]	SERVICE LED	[Q]	Relay terminals 3
[H]	Optional Wi-Fi board connector	[R]	Relay terminals 6
[I]	Buzzer	[S]	Relay terminals 5
[J]	Loop activity LED	[T]	Relay terminals 4
		[U]	I/O3, I/O4 terminals
		[V]	Functional earth terminal

2.2 Technical specifications of FA100

Aspiration pipes	
Number of pipes	2 aspiration pipes 1 exhaust pipe
Pipe diameter	internal 21 mm
	external 25 mm
Maximum number of sampling holes for each pipe	Class A 8 sampling holes
	Class B 18 sampling holes
	Class C 51 sampling holes
Maximum overall length of the pipes	160 m
Maximum distance of a sampling hole from the detector	100 m
Exhaust pipe length	recommended 0.5m
	maximum 10m
	nominal 24 V _~
Primary/Ancillary power-supply	range from 20 to 30 V _~
	from external power-supply
Maximum current draw	400mA @ 24V
Aspiration fan speed	1500 to 4750 RPM (250 RPM resolution)
Maximum output current	I/O terminals 150mA @ 30V _~
	relay 2A @ 30V _~ , 30V _~
Battery for date/time	CR2032

Display	Graphic LCD 192 x 64 pixel, backlit	
Information relative to the isolator		
V_{IN} (loop)	nominal	24 V \pm
	minimum	19 V \pm
	maximum	30 V \pm
V_{SO}	minimum	9.5 V \pm
	maximum	13 V \pm
V_{SC}	minimum	3 V \pm
	maximum	9 V \pm
I_C	maximum	600 mA
I_L	maximum	15 mA
I_S	maximum	600 mA
Z_C	maximum	0.5 Ω
Detector sensitivity	Class A	from 235 to 2500 · 10 ⁻⁵ dB/m
	Class B	from 235 to 6000 · 10 ⁻⁵ dB/m
	Class C	from 235 to 20000 · 10 ⁻⁵ dB/m
Box material	ABS	
Dimensions (W x H x D)	190 x 395 x 117 mm	
Weight	1.95 Kg	
Operating environmental conditions		
Temperature	from -10°C to +55°C	
Relative humidity	≤93%, without condensation	

2.3 Connection terminals

Loop terminals

FA100 has terminals for two-way connection to the addressable loop with Inim Electronics control panels (*Description of the PCB, [K]*): signalling of warning, alarm, faults, diagnostics and programming of detector sensitivity, nominal flow rate, high/low flow fault thresholds, aspirator speed.

The device must occupy one address on the loop for each available detector module.

PRIM terminals

Terminals for the primary power connection (*Description of the PCB, [L]*).

AUX terminals

"AUX" is an input for the attainment of a redundant power supply in the event of primary power-supply failure (*Description of the PCB, [M]*).

I/O terminals

The "I/O 1, 2, 3 and 4" terminals are two-way and programmable (*Description of the PCB, [N], [U]*).

When the terminals are configured as open-collector outputs, they can be used to signal warning or alarm status, such as in cases where FA100 is mounted in a hidden position (e.g. in a false ceiling).

These open collector type outputs can be monitored.

When the terminals are configured as inputs they can activate functions such as resetting the device, excluding a single detector or placing the entire device in service mode, muting the buzzer, monitoring the relays (to be used, for example, for connection of relay outputs to conventional control panels).

The terminal blocks also provide the "+24V" terminal which supplies a supply voltage limited to 400mA.

RELAY terminals

FA100 has 6 dual-switching relay-type terminals, potential free contacts (*Description of the PCB, [O], [T]*).

The activation of the relays and open-collector outputs can be programmed to respond to the events of:

- smoke warning level exceeded for single aspiration pipe
- smoke alarm level exceeded for single aspiration pipe
- Customized smoke alarm threshold exceeded for single aspiration pipe
- detector module faults:
 - detector module not present
 - no communication
 - optic fault
 - contamination
 - high flow fault (e.g. breakage)

- low flow fault (e.g. blockage)
- flow meter fault
- bypassed detector module
- common faults:
 - programming data corruption fault
 - firmware upgrade error
 - main power-supply fault
 - auxiliary power-supply fault
 - blower fault
 - communication fault on loop
 - loop isolator open
 - I/O supervision fault
 - service mode
- temperature threshold exceeded for single aspiration pipe
- activation of remote control panel output (on loop)
- date / time change
- user PIN entered
- invalid user PIN
- status change of a programmable input

Default programming involves the following activation of these terminals:

- "RELAY 1", detector module 1 fault
- "RELAY 2", detector module 1 smoke alarm level exceeded
- "RELAY 3", detector module 1 smoke warning level exceeded
- "RELAY 4", detector module 2 fault
- "RELAY 5", detector module 2 smoke alarm level exceeded
- "RELAY 6", detector module 2 smoke warning level exceeded

Functional earth terminal of the device (*Description of the PCB, [V]*).



**Ground
terminal**



2.4

Buttons

FA100 has 4 buttons for consultation and programming.

The functions of these buttons may vary, depending on the section that is active on the display or on for how long the button is pressed.

Button	function	PIN entry	long pressing
	Exit the sub-menus. Cancel the data entry	Enter the digit "0"	Pressing and holding (for over 1 s), forces return to the main menu Esc
	Menu navigation upwards	Enter the digit "1"	-

Button	function	PIN entry	long pressing
	Menu navigation downwards	Enter the digit "2"	-
	Access sub-menus. Confirm entered data.	Enter the digit "3"	Pressing and holding (for over 1 s), forces all the LEDs on 

The motherboard provides two buttons for resetting the device:

- **RESET**, forces the restart of the device.
- **FACTORY**, pressing for more than 5 seconds forces restoral of the programming options.

2.5 Service mode, disablement and bypass status

The FA100 device can be placed in service mode and individual detector modules can be bypassed (isolated) or disabled.

The various possibilities can be activated by the user in various ways and are described in the table in order of priority:

Status	priority	Activation mode	after a reboot
Disablement detector 1 and/or detector 2 module.	high	By activating the option: Settings > Detectors > Class > Detector disabled	unchanged status
		via RUN / SERVICE switch	unchanged status
FA100 service	intermediate	via programming menu	status cancelled
		via programmed input	unchanged status
		via programming menu	status cancelled
Bypass detector 1 and/or detector 2 module	low	via programming menu	status cancelled
		via programmed input	unchanged status

Status	effects				
	smoke detection, events log, measurements history	aspirator	events which activate outputs	Faults signalling	signalling on loop
Disablement detector 1 and/or detector 2 module	disabled	deactivated if both detectors are disabled	disabled all those relating to the detectors involved	disabled all advanced signals relating to the detectors involved	the addressed detector does not respond to queries from the control panel
FA100 service	enabled	depending on programming	disabled all except the "service mode" fault	disabled all except "general fault"	disabled all except "service mode"
Bypass detector 1 and/or detector 2 module	enabled	active	disabled all those relating to the detectors involved except for the "bypassed detector" fault	disabled all signalling relating to the detectors involved except for "pipe 1/2 fault"	disabled all signalling relating to the detectors involved except the "bypassed detector"

Notes

The service status and bypassed status of the detectors are not affected by resetting the device or the individual detectors.

If the events that activate the outputs are disabled, the conditions imposed by the generic inputs "I/O 1...4" remain active.







Chapter 3 Feedback signals provided by FA100

3.1 LED signalling

FA100 provides signals via the LEDs on the user interface, located above the LCD display on the lid (*Description of parts, [E]*), referring to the entire system or to the single aspirator and detection line (\mathcal{N}_1 and \mathcal{N}_2).

Further information is provided by the LEDs that motherboard is equipped with (*Description of the PCB, [J]*).

Frontal LEDs



LEDs		signalling	
icon	colour	ON solid	blinking
	green	The device is functioning.	-
	yellow	The primary power supply or the auxiliary power supply (if enabled by programming) are lower than the minimum nominal value.	-
	yellow	The LED signals faults relating to the entire device: <ul style="list-style-type: none"> Blower fault (the blower has stopped or does not rotate at the set speed) Communication fault on the addressable control panel loop Programming data corruption Device in service mode 	-
	green	Indicates that the detector module to which the icon refers is enabled and operating properly.	-
	yellow	Indicates a fault with the relevant detector module or related pipe: <ul style="list-style-type: none"> Module fault (smoke detection error, flow measurement error, module not present or communication loss, etc.) Aspiration flow fault: high flow (pipe breakage) or low flow (obstruction) Detector bypass 	-
	red	Indicates that the level of smoke detected by the module to which the icon refers exceeds the alarm threshold.	Indicates that the smoke level detected by the smoke module exceeds the warning threshold.

LEDs on the motherboard

LEDs		signalling	
label	colour	ON solid	blinking
RUN	green	The RUN/SERVICE switch is in the "RUN" position: the device is operating.	-
SERVICE	yellow	The RUN/SERVICE switch is in the "SERVICE" position: the device is in maintenance mode.	-
LOOP	yellow	If the "Automatic LED management" option is enabled on the control panel and one of the following faults is present: <ul style="list-style-type: none"> Motherboard communication fault Isolator open. Sampling chamber fault Remote output monitoring fault 	-
LOOP	green	The fire control panel switches on the LED	Fast blinking (700 ms) with insufficient loop voltage (below 12.5V) Single blinking on each query received from the control panel

3.2 Buzzer signalling

The buzzer on the motherboard provides the following signals:

Signalling	cadence and tone	activation	deactivation
bop	200ms, 500Hz	Operation on user interface rejected.	-
beep	50ms, 3kHz	Operation confirmed on user interface.	-
alarm	2kHz	The smoke alarm threshold has been exceeded and detected.	Button pressed Device reset
early-warning	On 200ms / Off 200ms, 2kHz	The smoke early-warning threshold has been exceeded and detected.	Activation of an input with the mute buzzer function Resetting of the smoke level (if the automatic reset option is active)
fault	On 1s / Off 1s, 2kHz	A fault has been detected (<i>activation of  and  LEDs</i>).	Button pressed Device reset Resetting of all faults.

Note

The alarm signal has maximum priority.
The early-warning signal has priority over the fault signal.

The audible signalling of an alarm or fault by the buzzer are enabled via the "Audio signal on alert/fault" option, disabled at default.

The audible signals for confirmation or refusal of an operation ("beep" and "bop") are enabled by the "Buttons tone" option, enabled by default.

The options are programmable via the local menu.

Chapter 4 LCD display

The display of the FA100 is equipped with is a graphic LCD, backlit, with a resolution of 192 x 64 pixels.

It provides direct access to the measurements of the detectors supplied and to programming via the buttons positioned underneath.

4.1 Main screen

The main screen of the display is shown during normal operation, with no signals in progress or without the entry of the PIN code by a user or installer.

[A]	Status of detector 1	
[B]	Status of detector 2 (if present)	
[C]	General information	
[D]	PIN code entered	

Detector status

The main screen continuously shows the values measured by the detector:

- **Smoke, bar with levels**, shows the level of the quantity of smoke detected with respect to the thresholds set by programming:
 - Early warning threshold
 - Alarm threshold
 - "Custom" threshold
- **Smoke %**, i.e. the percentage of smoke detected, in dB/m, compared to that set for the alarm threshold. The device goes into alarm status when the smoke level remains above 100% for the programmable delay time.
- **Flow, bar with levels**, shows the level of the aspirated air flow with respect to the thresholds set by programming:
 - Minimum flow threshold
 - Maximum flow threshold
- **Flow %**, i.e. the percentage of measured flow detected, in l/min, with respect to a nominal value set during programming
- Product name and brand
- Date and time
- Aspiration fan speed, in RPM (fan revolutions per minute)

General information

4.2 Warning screens

In the event of signalling such as a smoke alarm or ongoing fault signalling, the main screen of the display will be replaced by warning screens.

These screens will show the data relating to any ongoing signalling.

In the event of several simultaneous signals, the smoke detection signals take precedence over all other ongoing signals, in the following order:

1. alarm
2. early-warning
3. custom

If there is no signalling relating to smoke detection, any faults that may be present will be displayed in rotation:

[A]	Signalling	 The image shows a monochrome LCD display with a teal background. At the top left, there is a small icon of a triangle with a circle inside, labeled 'A'. To its right, the text reads 'FAULT', 'LOW AIRFLOW RATE', and 'DETECTOR 1'. Below this, there is a horizontal line. Underneath the line, the text 'Smoke Flow' is displayed, with '0%' on the left and '20%' on the right. To the right of this, the text 'Enter PIN' is displayed, followed by a small icon of a keypad, labeled 'C'. A label 'B' is positioned to the left of the 'Smoke Flow' text.
[B]	Detector reading in progress	
[C]	PIN code entered	

Chapter 5 Access to user / installer menu

In order to access their menus, the installer must first have their codes validated.

To do this, the respective PIN must be entered using the buttons located under the display.



The features of the PIN code depend on the access level of the user ("Access levels"):

Level		access mode
Public access	1	None
User	2	User PIN, 6 digits from "0" to "3") default "000000"
Installer	3	Installer PIN, 6 digits (from "0" to "3") default "111111"
Maintenance	4	Software update

The first digit of the PIN identifies the type ("0" for the user and "1" for the installer).

When changing the PIN, this digit cannot be changed. By accessing the "Change my PIN" menu option, the user can only change the 5 digits after the first.

The menu provides the following sections:

- **Language**, section where it is possible select the language used by display
- **Faults**, navigable section containing a list of current faults
- **Settings**, section for changing the system settings and its parts.
This section is available only for the installer.
- **Loop**, section for the visualization/changing of the logic address associated with the device when connected to the addressable loop of a Inim Electronics control panel.
This section is available only for the installer.
- **Service**, section with the list of operations to be activated for the implementation of any maintenance procedures.
This section is available only for the installer.
- **Date/time**, section where it is possible to set the date and time used by FA100
- **Change my PIN**, section where it is possible to set the PIN
- **Events log**, section with the navigable list of events recorded in the memory
- **Info**, section for viewing the diagnostic data of the device

5.1 Settings

The settings of FA100 and parts of the system can be accessed and changed via the following path:

Installer PIN code, Main menu, Settings

This section provides access to:

- **Detectors**, section where you can select and change the settings of each of the available detectors, after selecting:
 - **Class**, detector classification (A, B or C according to EN 54-20)
 - **Sensitivity**, represents the alarm threshold of the smoke detector.
This can be calculated by means of the FA/STUDIO software based on the piping drawing (piping length, number and size of sampling holes, aspirator speed, etc.) or can be determined using the pre-calculated tables attached to this manual.

EN54-20

This setting affects compliance with EN 54-20.

- **Flow thresholds**, minimum (low flow) and maximum (high flow) fault thresholds expressed as a percentage.
For example, a minimum threshold of -15% means that the device will report a low flow fault when the measured air flow is reduced by 15% of the nominal flow rate.

EN54-20

The increase of the maximum threshold and the reduction of the minimum threshold compared to the default values (+15% and -15% respectively) involve the invalidation of the compliance with the EN 54-20 standard.

- **Nominal flow rate**, value of the nominal intake air flow in l/min.
This can be calculated by means of the FA/STUDIO software on the basis of the layout of the pipes and the relative positioning of the sampling holes or determined by means of the pre-calculated tables attached to this manual.

EN54-20

This setting affects compliance with EN 54-20.

- **Save**, to exit the current section saving the changes made
- **Auto**, function which, if activated, initiates an automatic calibration of the flow measurement and resets the nominal flow rate.
This operation must be carried out during the first installation and after each scheduled maintenance session.
- **Blower speed**, where the speed of the aspirator fan is to be set:
 - **Current RPM**, current speed value (expressed in revolutions per minute)
 - **Setpoint RPM**, speed setting value (expressed in revolutions per minute).
This can be calculated by means of the FA/STUDIO software on the basis of the layout of the pipes and the relative positioning of the sampling holes or determined by means of the pre-calculated tables attached to this manual.

EN54-20

This setting affects compliance with EN 54-20.

- **Save**, to exit the current section saving the changes made
- **Auto**, function which, if activated, starts the search for an aspirator speed such that the flow of aspirated air is as close as possible to the nominal one.
This operation can be carried out if necessary during the first installation phase and after a scheduled maintenance session.
- **Options**, section for the setting of the following options:
 - **Automatic alarm restore**, if activated, this option allows the reset of the status of warning/alarm (LED signals, LCD display, relays/outputs status) when the measured smoke level drops below the thresholds.
If this option is not activated, reset of alarm/warning can be done manually via the menu *Service, Rearm*.

EN54-20

For compliance with EN 54-20, this option must not be activated.

- **Loop**, option that enables/disables the connection of the device to the addressable Inim Electronics loop.

- **WiFi**, option that enables/disables device communication through a Wi-Fi network.
Wi-Fi communication is subject to the insertion of the optional FA100-WIFI card in the appropriate connector (*Description of the PCB, [H]*).
- **Buttons tone**, for the reproduction of a “beep” following the pressing of each key
- **Audio signal on Alert/Fault**, if activated, following the signalling of a smoke alarm or an ongoing fault, FA100 reproduces a sound (see “*Buzzer signalling*”)
- **Save**, to exit the current section saving the changes made

5.2 Service

The main menu of the installer has an option with functions that can be used during the system maintenance phase:

Installer PIN code, Main menu, Service

This section allows access to the following functions:

- **Service mode**, this option activates maintenance status (“FA100 service”, “*Service mode, disablement and bypass status*”)
- **Bypass detector**, this option allows the bypassing of detection modules (“Bypass detector 1 and/or detector 2 module”, “*Service mode, disablement and bypass status*”)
- **Apply**, to exit this section and save the changes made
- **Rearm**, to start the total rearming of the device with consequent resetting of any alarm or warning conditions

5.3 View

Via the main menu it is also possible to visualize the status of different parts of FA100:

Installer PIN code, Main menu, Info

This section provides access to:

- **Detectors**, section where it is possible to view, after selection, the current values of each of the available detectors:
 - **Obscuration level**, percentage of smoke detected with respect to the alarm threshold
 - **Reliability rate**, a value that indicates the presence of particles with a diameter of less than 1 μm in the aspirated particulate.
These particles characterize a fire and allow this situation to be discriminated against false alarms due to misleading phenomena (e.g. dust).
The value ranges from 0 to 200; the maximum value indicates the minimum probability of a false alarm.
 - **Contamination level**, level of contamination of the detector module from dust, particles, etc.
 - **Airflow rate**, aspirated, in l/min
 - **Temperature**
- **WiFi**, section for WiFi connection diagnostics:
 - **Mode**, selection of the operating mode of the “Transceiver station” or “Access point” (see “*Connection*”)
 - **IP address**, IP address associated with FA100
 - **Gateway**, IP address of the gateway.
 - **Network mask**
 - **MAC address**

- **Connection**, when the selected operating mode is "Transceiver station", the status of the connection to the Wi-Fi network will be displayed; when the selected operating mode is "Access point", the list of network devices connected to FA100 will be displayed
- **I/O**, section where you can view the characteristics of the 4 I/O terminals with which the FA100 motherboard is equipped. For each terminal it is possible to read, after selecting it:
 - **Description**, customizable label used to identify the terminal
 - **Direction**, whether input or output
 - **Polarity**, normally open / normally closed
 - **Reference**, input referred to negative (ground) and to positive (+24V)
 - **State**, visualization of the terminal status (active, stand-by, interconnection fault)
- **Relay**, section where it is possible to view the characteristics of the 6 Relay terminals with which the FA100 motherboard is equipped. For each terminal, after its selection, it is possible to read:
 - **Description**, customizable label used to identify the terminal
 - **State**, visualize the terminal status (active, stand-by)
- **Power supply**, section where you can view the current voltage of both the primary power supply, supplied via the "PRIM" terminals, and the auxiliary power supply, supplied via the "AUX" terminals.
- **Firmware version**, section where it is possible to consult the firmware revision installed on the FA100 motherboard, loop interface and detectors in use.
In this section it is also possible to view the version of the programming data (it is increased with each programming change).
- **Serial numbers**, section where it is possible to consult the serial number of the FA100 motherboard, loop interface and the detectors in use.

Chapter 6 Connections

The connections described below must be made with a shielded bipolar cable. Unless otherwise indicated, the shield should not be connected.

6.1 Power supply

The power-supply of FA100 is possible through the "PRIM" terminals (*Description of the PCB, [L]*).

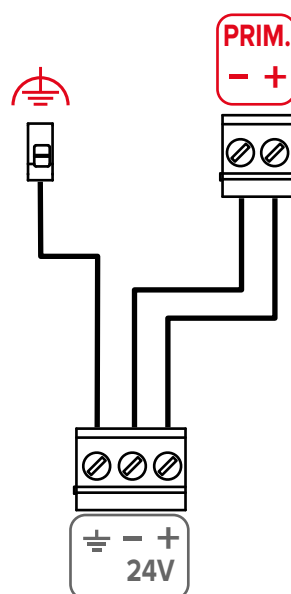

However, it is possible to apply a connection to obtain a redundant power supply, if the primary power supply fails, through the "AUX" terminals (*Description of the PCB, [M]*).

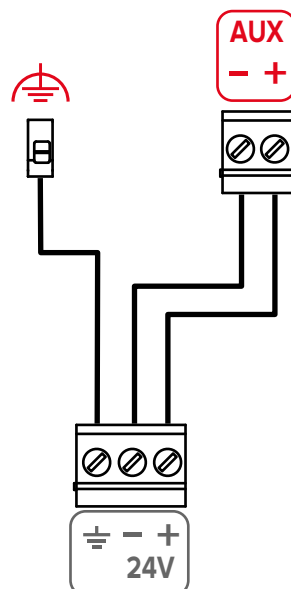

EN54-4

It is necessary to use a power supply that complies with the EN 54-4 standard.

6.2 Programmable inputs

When the "I/O 1 .. 4" terminals are programmed as inputs they can be used to activate device functions.

The input programming options are available via FA/STUDIO software.

Following are some examples of wiring diagrams for inputs based on the "Monitoring" and "Reference" programming options:

Monitoring	"Reference" option	
	positive	negative
disabled		
enabled		

The inputs have pre-established thresholds for switching between one status and another (for example for the transition from stand-by to activated status). The FA/STUDIO software permits changes to these thresholds.

Relay monitoring

An input can have the function of monitoring the status of a relay to which a +24V load is connected.

The reference wiring diagram is as follows:

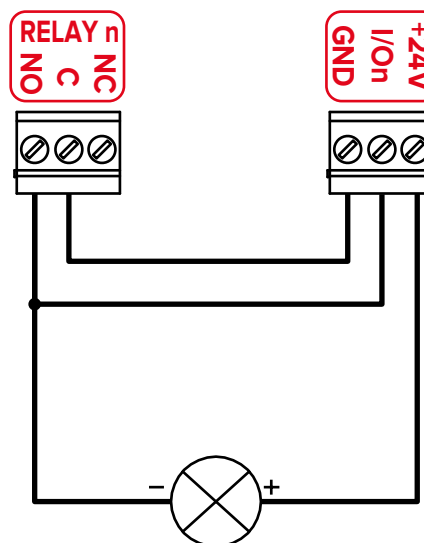

The fault detection threshold is not programmable

6.3 Programmable outputs

FA100 is equipped with the following outputs:

- the relay outputs "RELAY 1 .. 6", potential free switching contacts
- the "I/O 1 .. 4" terminals, when programmed as open-collector outputs

Reference wiring diagrams for relays and I/O outputs are shown below:

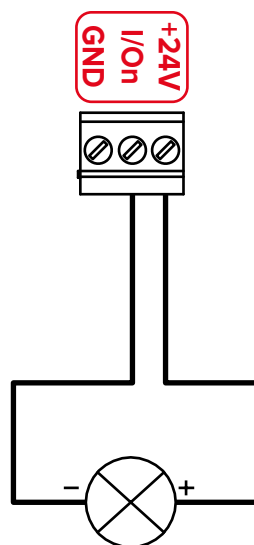
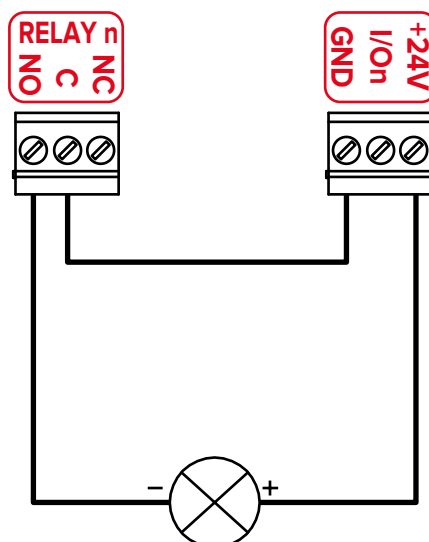

The characteristics of the outputs are fully programmable and these options are available via FA/STUDIO software.

The activation of the outputs occurs in correspondence with the programmed events; however, activation can be conditioned by the status of one or more "I/O 1..4" inputs (AND or OR logic).

6.4 Connection to a fire-control panel

Conventional connection

To connect FA100 with a conventional fire control panel it is necessary to use a group of relay outputs connected to a control panel zone and an input for monitoring.

During programming it is necessary to characterize these outputs according to the signal to be reported:

- a relay activated by a smoke alarm event
- a relay activated by a fault event
- a relay activated by an early-warning smoke-event
- an input with “conventional zone monitoring” function

Below is a typical connection to a SmartLine conventional fire panel from Inim Electronics for the reporting of fault and alarm signalling:

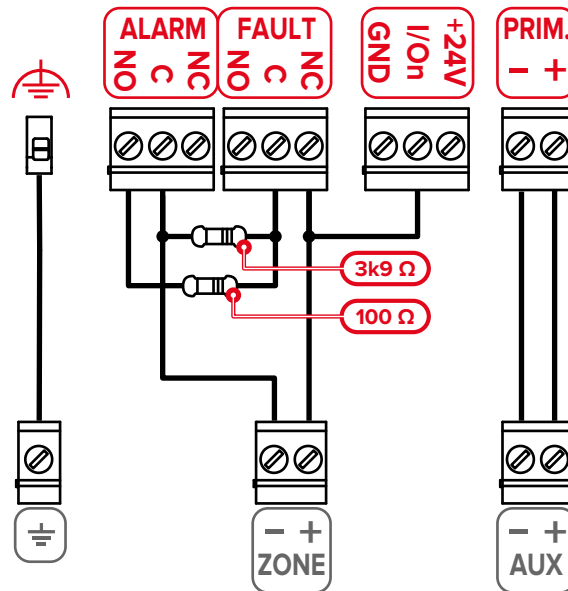

Below is a typical connection to a SmartLine conventional fire panel from Inim Electronics for the reporting of fault, warning and alarm signalling:

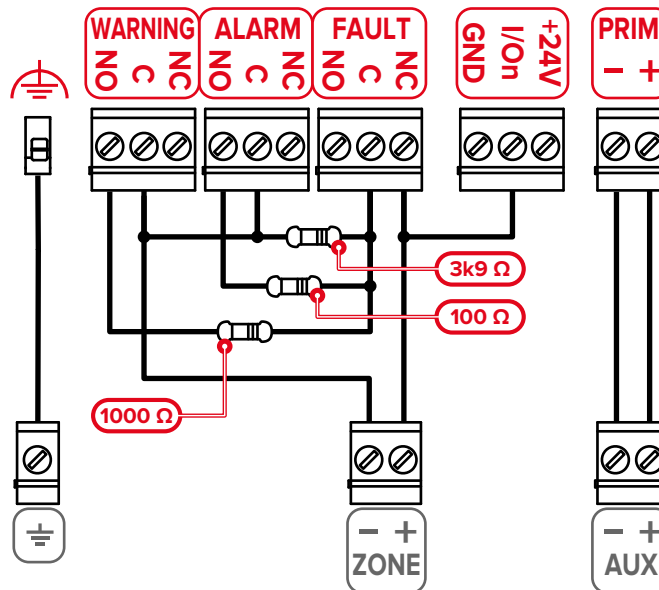

Analog connection

To connect FA100 to a Inim Electronics analogue fire detection control panel, it is necessary to use the “Loop” terminals and then to address the FAD100 detector modules in use. The control panel will see such modules as smoke detectors on the loop.

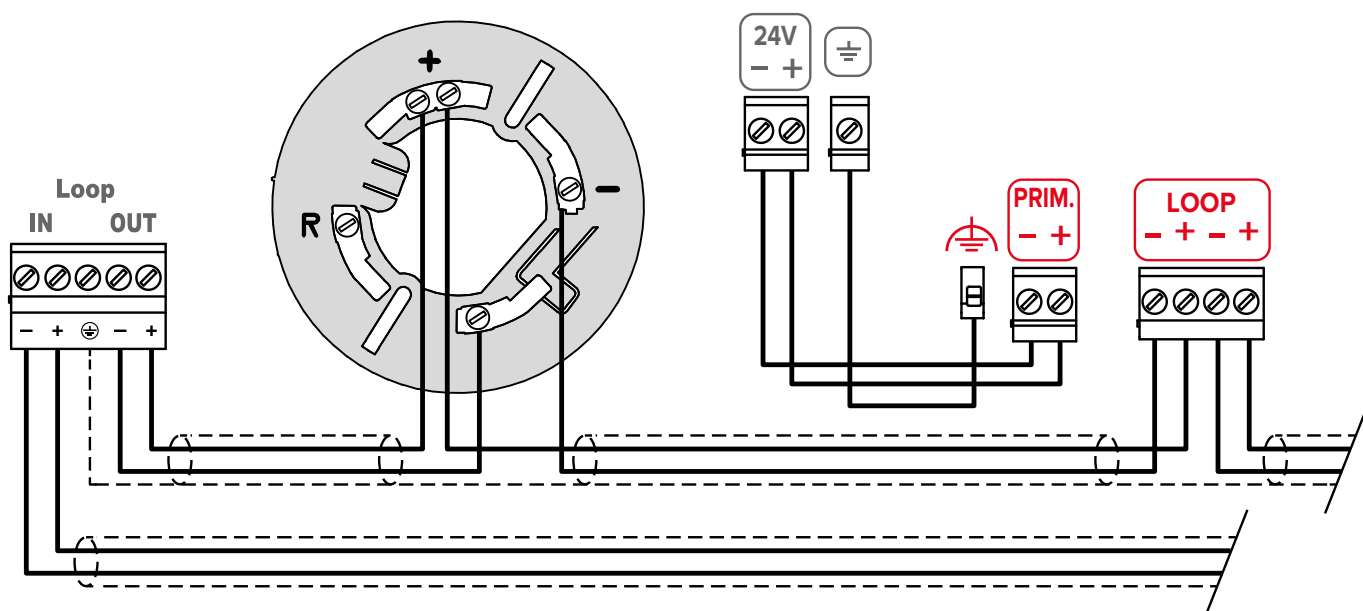

The cable shield should be connected only to the control panel earth terminal, as shown in the figure.

Chapter 7 FA/STUDIO software



The FA/STUDIO software allows the design of an aspirating smoke detection system, the programming of the FA100 devices and the related diagnostic functions.

The software manages a database relating to aspirating smoke detection systems: layout of the pipes (number of branches, length of branches, etc.), position and diameter of the sampling holes, floor plans of rooms, list of materials, programming data of FA100 devices.

In the database, the data of an installation are collected in a logical grouping named a "solution". Within a solution, the different floor plans of the environment to be protected can be arranged on several floors and each of which can house different FA100 devices connected to the relative pipes.

On the main screen of the software it is possible to add all the FA100 devices necessary for the system and from here it is possible to move on to the different sections:

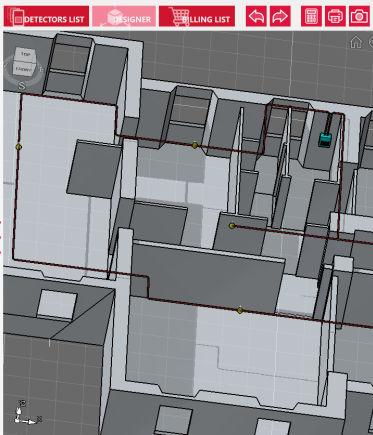

- **Designer**, a 3D CAD environment through which it is possible to:
 - import a plan of the room in .DWG or .DXF format.
 - draw the aspirator pipe, position the sampling holes and all the elements of the system (fittings, dust filters, condensate traps, etc.).
 - Carry out the fluid dynamics calculation to determine compliance of the system with sensitivity classes A, B or C. The software can also automatically balance the system, i.e. find the most suitable aspiration speed and the size of each sampling hole in such a way that they aspirate in the same amount of air (and therefore have the same detection sensitivity). Based on the number of sampling holes and the fluid dynamics calculation, the software also determines the sensitivity to be programmed on the device.

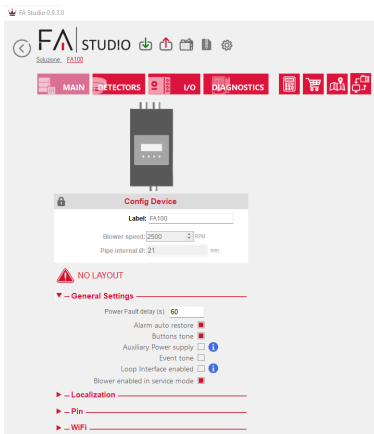

- **Programming**, allows you to define the programming parameters and transfer them to the FA100 device through a USB or Wi-Fi (optional) connection. The programming parameters are grouped into several sub-sections:
 - **Main**, aspirator speed, enable addressable loop connection, enable Wi-Fi interface, change PIN, etc.
 - **Detectors**, class, sensitivity, alarm (smoke detection) and fault (high/low flow) thresholds.
 - **I/O**, parameters related to the input/output terminals and the relays (associated functionality, polarity, direction, reference, programmable thresholds, etc.)



- **Diagnostics**, through a USB or Wi-Fi (optional) connection, allows you to read from the FA100 device a series of useful data for checking the operating status and for diagnosing any problems. The data is grouped into the following sub-sections:
 - **Motherboard status**, allows visualization of the presence of faults, the status of activation/fault of the input output terminals and relays and the measurements of the aspiration speed and supply voltages.
 - **Real-time data**, graph over time of the data measured in real time by the detector modules (smoke level, contamination, flow rate and air temperature).
 - **Data history** (data logger), graph over time of the data stored by the detector modules in a non-volatile memory of the device (smoke level, contamination, flow rate and air temperature). The data is related to the recorded alarm/fault events.
 - **Events log**, reading of fault/alarm events stored in the non-volatile memory of the device.

Contact Inim Electronics S.r.l. to participate in training courses that include the use of the FA/STUDIO software.

On the *Website of Inim Electronics* tutorials are available relating to the use of the software.

Chapter 8 Plant engineering

Building an aspirating smoke detection system requires the completion of four basic steps:

1. project design
2. installation
3. commissioning
4. scheduled service

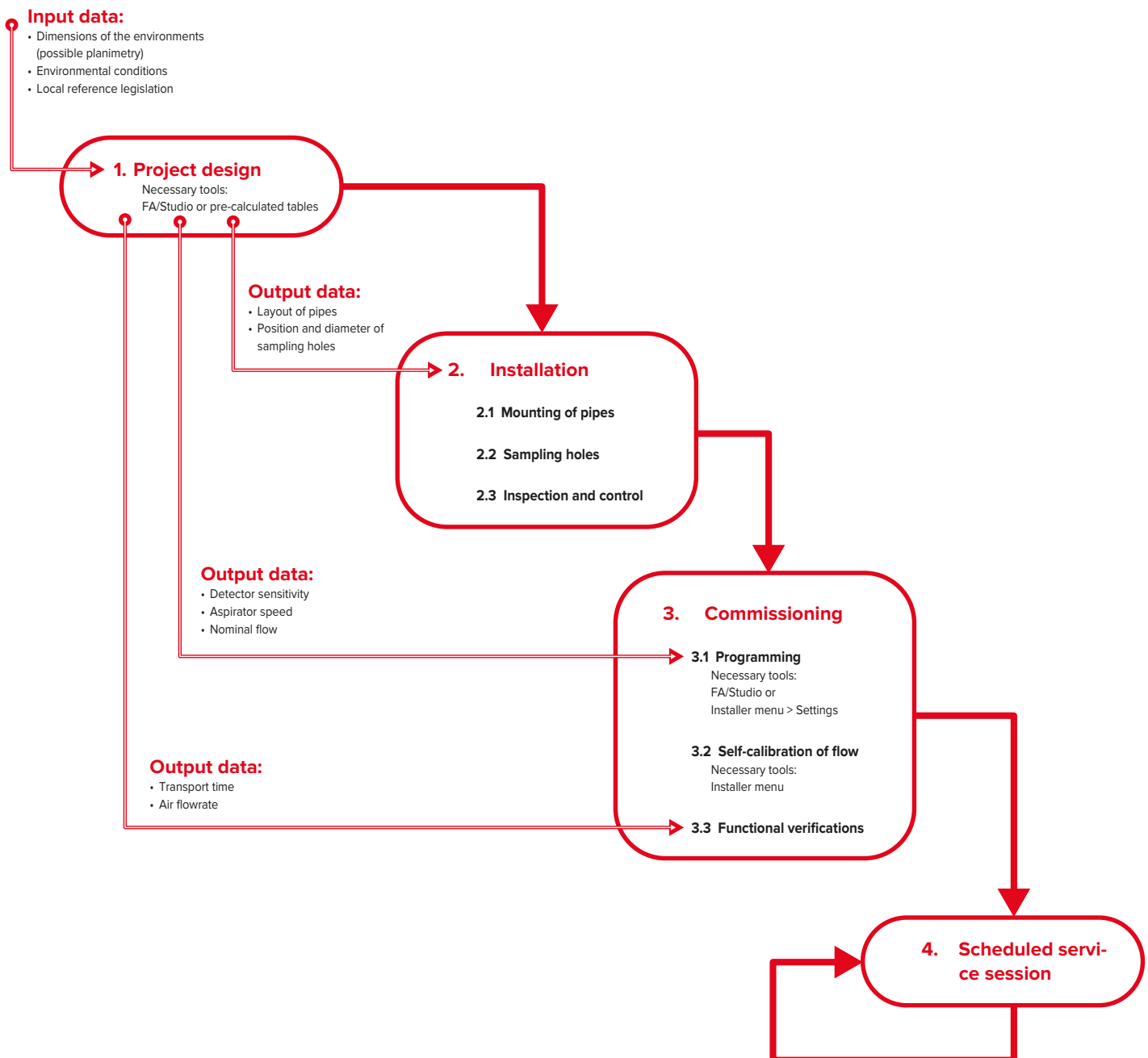

8.1 Project

In the design phase of an aspirating smoke detection system, it is first of all necessary to identify the class of sensitivity to be applied according to the type of environment to be protected (see "Detection classes").

The configuration parameters of the aspirating system, such as the diameter of the sampling holes, the detection sensitivity, the aspirating speed, etc., can be calculated by means of the FA/STUDIO software or can be determined using the pre-calculated tables attached to this manual.

System layout limitations

Whatever the design method, the following constraints must in all cases be respected:

- The total length of the aspirating network can be at most 160 m.
In the case of the FA100 device two detector modules are installed, the overall length is given by the sum of the pipes lengths of each detector module.
- The maximum distance of a sample hole from the FA100 device is 100m.
- The piping system can have a maximum of 4 branches for each detection module.
- The maximum length of the exhaust pipe is 10m.
To reduce the noise of the exhaust it is advisable to connect a pipe of a least 50cm.
- The sampling holes must be positioned at least 25cm from the system parts such as:
 - bends (SABE300250RS)
 - joint sleeves (SASO100250RS)
 - T-fittings (SATE400250RS)
 - capillary kit (CAPKIT2510SR)
 - anti-dust filter (504F075ABS)
 - condensate trap (WT025)
 - etc.
- The minimum distance between sampling holes is 10cm.
- The capillary sampling kits (CAPKIT2510SR) must be spaced apart from each other and from the other parts of the system by at least 25cm.
The maximum length of the capillary pipe is 2m.
- The T-fittings (SATE400250RS) must be spaced apart from each other and from the other parts of the system by at least 25cm.
- Only one dust filter (504F075ABS) and one condensate trap (WT025) can be used for each detector module.
The maximum distance of these components from the FA100 device is 2m. Sampling holes must not be positioned in the section of the pipe between the FA100 device and the dust filter or the condensate trap.

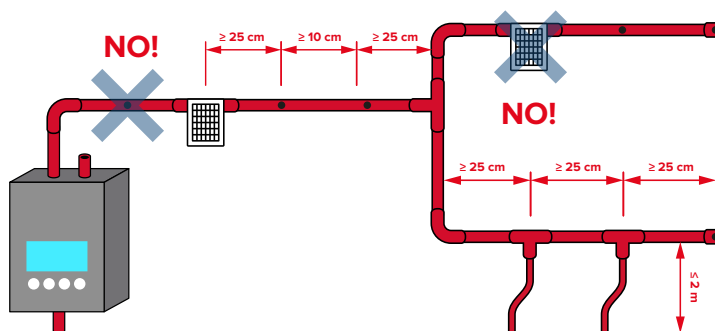

Sampling holes

The maximum number of sampling holes that can be drilled in the pipes depends on the sensitivity class chosen:

Sensitivity class	Number of holes
A	8
B	18
C	51

To define the coverage area of a sampling hole, the maximum number of holes that can be used in an area and their positioning (spacing, height, etc.) reference must be made to the local legislation in force.

Bends, joints and fittings



Each bend or T-junction introduces a change in the direction of the intake air flow and therefore their number must be limited as much as possible.

During the design phase, in order to simplify the correct maintenance and cleaning of the pipes, the system must include the appropriate accessories for the temporary removal of part of the pipes, such as the inspectable fittings (SAUN800250RS) and the three-way valves (2510025).

Below are some examples of use of the three-way valve (2510025):

[A]	Normal operation
[B]	Service: pipe cleaning
[C]	Service: test high flow fault
[D]	Valve position/Air flow
[E]	Aspirator

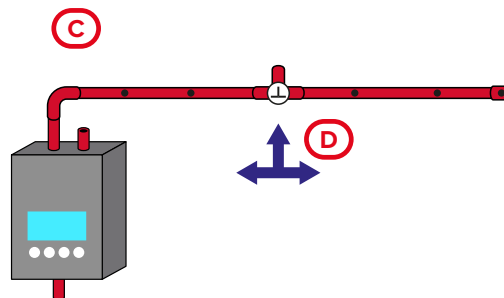
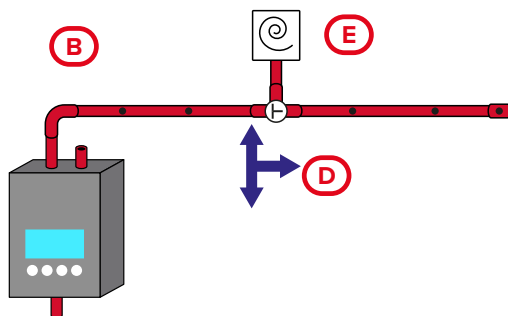
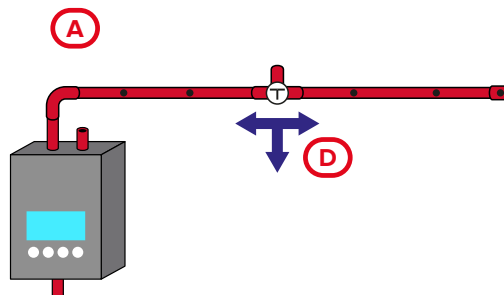

Separate environments

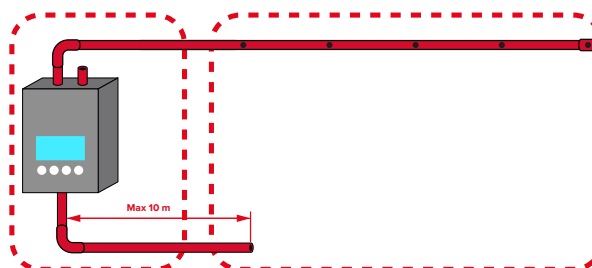

Care should be taken in cases where the FA100 device is installed in a separate environment from that protected (environment where the sampling holes are located).

If there is any possibility of a pressure difference between the two environments, it is necessary to provide for the return of the air from the exhaust to the protected room.

Condensation

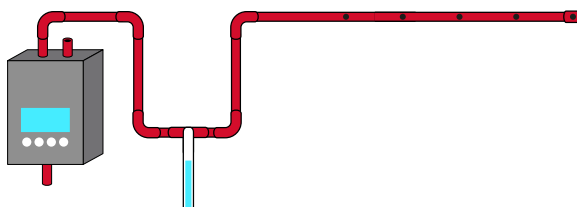

In environments with particular conditions of humidity or high temperature differences which predict the formation of condensation in the pipes, it is necessary to install a condensate trap (WT025) in the immediate vicinity of the FA100 device.

To eliminate the possibility that the condensate can reach the detection modules, the condensate trap must be installed at a lower height than the last section of pipe connected to the FA100 device.

Anti-dust filter



In the event of a high presence of dust in the environment, the use of the dust filter (504F075ABS) must be taken into consideration.

The installation must be planned before the sampled air reaches the FA100 device.

Expansion joints

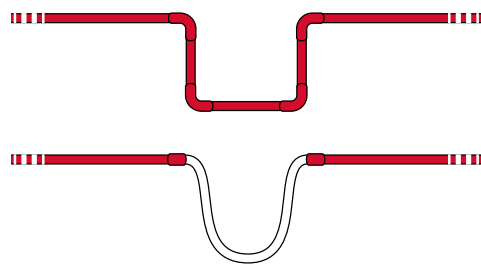

In systems consisting of long linear sections, installed in environments where there are significant temperature variations, the effects of thermal expansion of the pipes must be taken into consideration.

To compensate for these variations in length, it is advisable to provide expansion joints, i.e. extensions made with the standard pipe or with sections of flexible pipe.

To determine the distance between two expansion joints, it must be considered that the expansion coefficient of one meter of ABS TUBOABS0250M pipe is approximately equal to 0.1 mm / °C.

8.1.1

Use of a second FAD100



The FA100 can house a second FAD100 detector module (*Description of parts, [N]*) that offers the designer the possibility of having two protected areas, with the relative signalling clearly distinct.

During the programming phase it will be possible to combine these signals in order to process the output signal to the fire control panel.

However, the piping system of one detector must remain separate and independent from the system relating to the other detector and there must be no fittings or joints between the two systems.

In the case that one of the two detectors is no longer used, it must be disabled, removed from the device and end caps must be reinserted in the vicinity of the appropriate place (*Description of parts, [O]*).

8.2

Installation

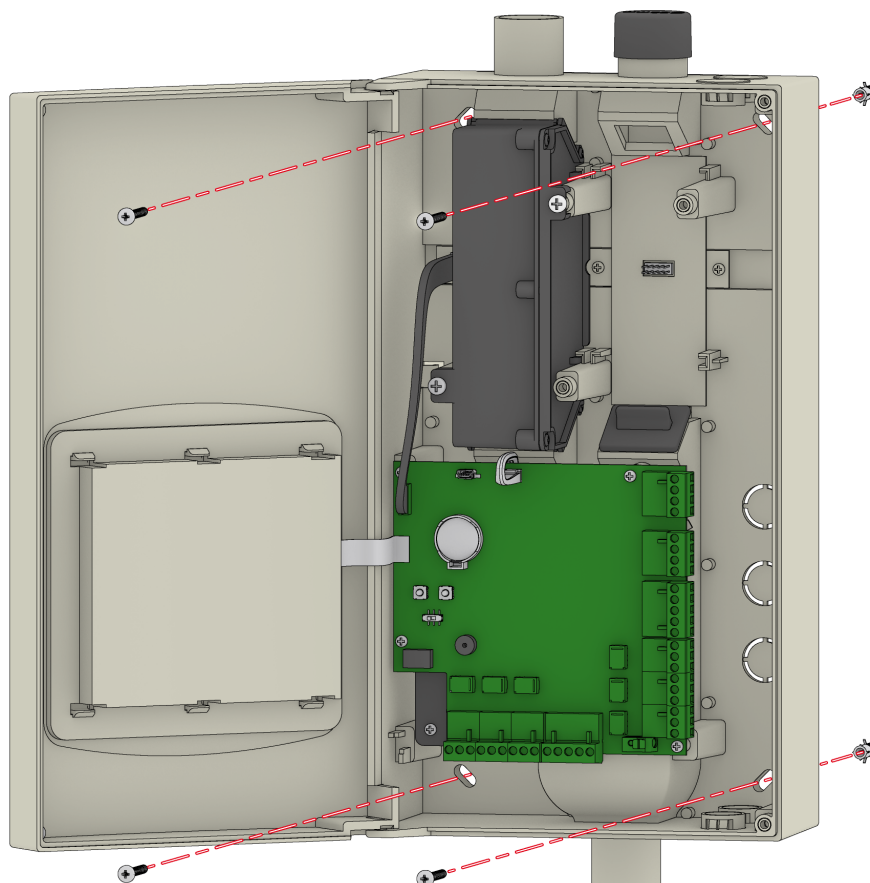

Following the design of the aspirating smoke detection system it is possible to know which elements are required and where they are to be installed:

1. Mount the FA100 device.
These must be fitted to a solid surface by means the screw locations on the back of the box (*Description of parts, [K]*). The wall plugs and anchor screws required for fitting are not supplied.
2. If required, insert optional modules (second FAD100 detection module , FA100-WIFI Wi-Fi interface board).
For the insertion of the FAD100 module in the appropriate housing (*Description of parts, [N]*) it is first necessary to remove the fitted caps (*Description of parts, [O]*).
If the module is not required, check that the caps are properly fitted.

Attention!

The detector modules and the Wi-Fi interface board cannot be inserted or removed when the FA100 device is powered.

3. Pull the cables through the appropriate holes (*Description of parts, [D]**Description of parts, [L]*) and complete the connections.
The use of 20 mm waterproof cable glands is required (not supplied by Inim Electronics).
4. Remove the insulating tab on the CR2032 battery (*Description of the PCB, [B]*).
5. Install the aspiration system components.
6. Check the system.

The FA100 device and any accessory components that require regular maintenance, such as the dust filter (504F075ABS) or the condensate trap (WT025), must be installed in an easily accessible place.

The FA100 device and the last section of the inlet pipes must be positioned away from heat sources and direct sunlight.

8.2.1 Installation of a second FAD100

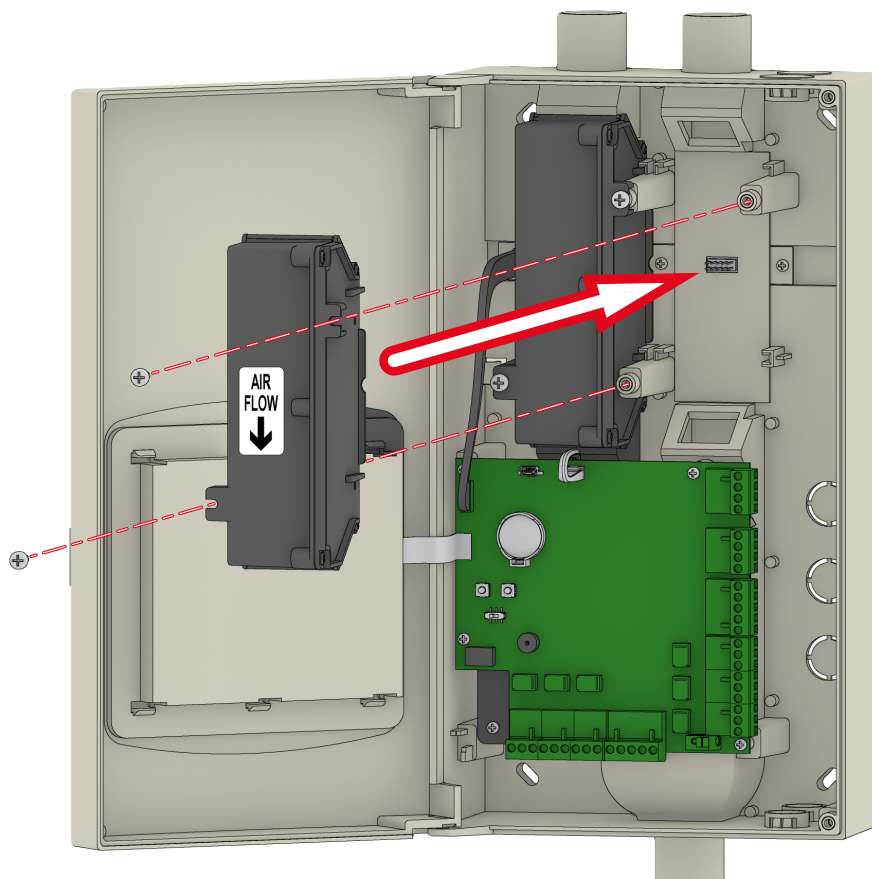

The FAD100 detector modules cannot be inserted or removed when the FA100 device is powered.

For the insertion of the FAD100 module in the appropriate housing (*Description of parts, [N]*) it is first necessary to remove the fitted caps (*Description of parts, [O]*).

Use only the screws provided in the package.

Enabling or disabling of a FAD100 detector module can be carried out from the installer menu (Settings, Detectors) or by means of the FA/STUDIO software.

Refer to the guide attached to the FAD100 module package.

8.2.2 Mounting the sampling pipes



The aspiration pipes must be attached securely to the walls by means of the appropriate pipe clips (STS25REDK).

Attachment must be firm and it is recommended to place a pipe clip every 1.5 m.

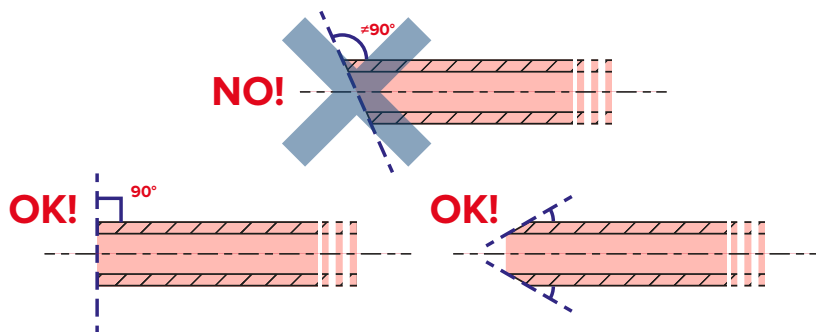

The cutting of ABS pipes must be done perpendicular to the longitudinal axis.

It is also advisable to produce a flaring at the end of the pipe which allows for optimal insertion in the fitting placements (joint sleeves, elbows, T-fittings, etc.).

To obtain a precise cut and to avoid chipping, the use of a pipe cutter is recommended. By means of this tool it is also possible to obtain the flaring useful during the insertion process.

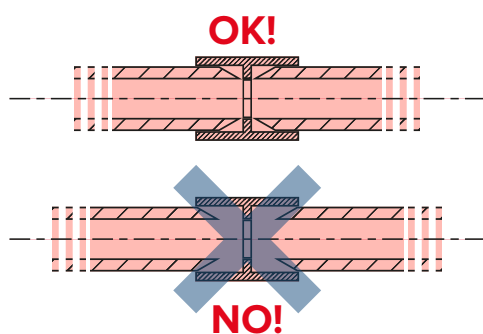

The insertion of the pipes into their locations must be done thoroughly, ensuring the pipe penetrate as much as possible.

Note

The pipe and fittings used for the aspirating pipe system must comply with requirements of Class 1131 according to EN 61386-1 standard.



In order to guarantee that the aspiration system pipes are perfectly sealed, the connection between the pipes and the fittings must be carried out using the special sealant glue available in packages of 250 ml (SGLUEN0250) or 500 ml (SGLUEN0500).

To simplify maintenance and possible replacement operations, the final section of the pipeline connected to the 1 and 2 aspiration pipe fitment (*Description of parts, [H], [I]*) and to the exhaust pipe fitment (*Description of parts, [J]*) of the FA100 device must not be glued.

8.2.3 Installation of the 504F075ABS filter

The 504F075ABS should be installed along the sampling pipe of aspirating smoke detection systems, in the vicinity of the detector inlet.

The maximum distance of the filter from the FA100 device is 2 m.

Sampling holes must not be made in the section of piping between the FA100 device and the filter.

Note

Protect from direct sunlight.

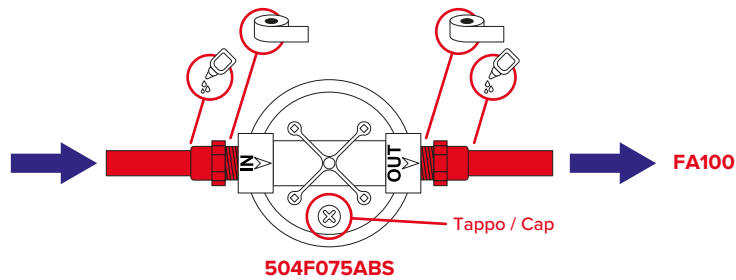

Respect the direction of the air flow indicated by the arrows positioned near the inlet mouth (marked "IN", aspirating system side) and the outlet mouth (marked "OUT", aspirating smoke detector side).

To seal the fittings, use PTFE (Teflon) tape on the threaded side and SGLUEN0250 / SGLUEN0500 glue on the piping side.

Ensure that the cap of the pressure gauge is well tightened (turn completely clockwise). Refer to the instruction guide inside the 504F075ABS filter package.

8.2.4 Sampling holes

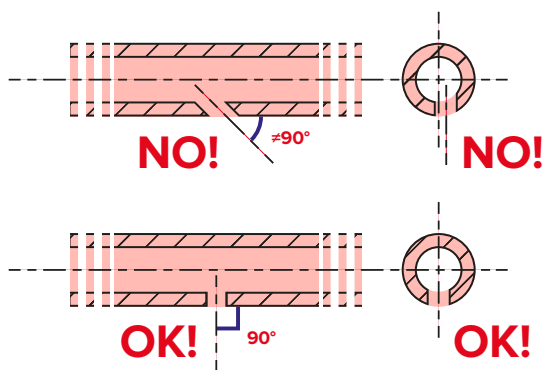

Sampling holes can be drilled directly along the pipeline.

These holes must be made perpendicular to the axis and in the direction of the radius of the pipe section.

It is necessary to carefully remove any shavings or other residue caused by work.

The diameter and position of the sampling holes can be calculated by means of the FA/STUDIO software or they can be determined using the pre-calculated tables attached to this manual.

The sampling holes must be positioned away from strong air currents such as, for example, those generated by air vents.

The identification of the sampling holes along the pipes can be made easier by using the "Aspirating point" labels (LABEL23X10).



Capillary kits (CAPKIT2510SR) can be used to dislocate the sampling point with respect to the aspiration line.

Several examples of application are:

- need to conceal the pipeline inside a false ceiling or similar
- protection of the gaps between ceiling beams
- surveillance of an object (electrical panel, rack of electronic devices, etc.).

In these cases, the sampling holes must be made in the centre of the terminal of the capillary kit.

It is necessary to carefully remove any shavings or other residue caused by work.

8.2.5 Inspection and verification

Once the installation of the aspirating smoke detection system has been completed, it is necessary to carry out a complete check to verify the correct laying of the pipes, the size, position and labeling of the sampling holes and the full compliance of the system with the design and local reference legislation.

During this phase it is advisable to remove any shavings or other residue remaining after work when installing the system or when connecting an aspirator for inspection.

If this is not possible, it is recommended that you leave the device in operating mode for 2 days, then clean the filter meshes as described in the "*Cleaning of the FAD100FILTER filter meshes*" paragraph.

8.3 Commissioning

Once the installation of the aspirating system has been completed, you can proceed with commissioning.

This involves verifying that the FA100 device is installed and functioning properly as well as the optional modules required by the project (second FAD100 detection module, FA100-WIFI Wi-Fi interface board).

8.3.1 Programming

During the device programming phase it is necessary to set the parameters relating to:

- detection class
- sensitivity
- nominal flow
- aspirator speed

The programming can be carried out via the installer menu (see "*Settings*") or via the FA/STUDIO software.

When using the software, it is necessary to connect the PC in use to the USB socket on the PCB board (*Description of the PCB, [A]*).

Note

Use the USB connection cable provided with the FA100.

At the end of the programming phase, remove the USB cable and close the box cover.

8.3.2 Auto-calibration of flow

1. Wait 15 minutes for the detector modules to complete initialisation.
2. Proceed with the auto-calibration of the nominal airflow phase:

Installer PIN code, Main menu, Settings, Detectors

3. In this section, select the first detector then go to *Auto!*, press "OK" and wait for the operation to finish.
4. If the second detector module is also installed, move up the screen within the same section until selected, then go back and press "OK" on *Auto!* to achieve auto-calibration on it.
5. Compare the nominal flow value obtained with that defined during the system design phase. If the values deviate by 20% or more, the speed of the aspirator can be changed (up to a maximum of ± 1000 RPM) and the auto-calibration operations repeated.
6. Go to *Save!* and press "OK" to save the nominal flow values determined by the auto-calibration operation.

At the end of this phase an air flow measurement that falls within the fault thresholds must be obtained. If it is not so, it will be necessary to repeat the operations described in paragraph "*Inspection and verification*".

8.3.3 Functional verification

Air flow checking

Check that the FA100 device does not signal the presence of faults, if so, close a number of sampling holes in such a way as to reduce the intake air flow by at least 20%.

Smoke detection test

At this point, check that the FA100 device detects the fault and correctly reports it to the fire control panel.

Reset the fault then open the pipeline at a suitable inspection point and check that the increase of 20% or more of the flow is detected by the FA100 device and that the fault signal correctly reaches the fire control panel.

Signalling of airflow faults (high or low) can take up to 300 seconds.

Once the flow fault has been restored, it is possible to proceed with the smoke detection test in correspondence of the sampling holes at the end of each branch of the aspirating system.

For this test the use of a smoke-generating wick is recommended, generally used to search for air infiltrations or leaks.

Smoke generated in the vicinity of the sampling hole must be detected by the FA100 device and the signalling must be sent to the fire control panel.

The necessary transportation time required to transfer the aerosol from the sampling hole to the FA100 device must be noted and compared with the project data.

The maximum acceptable transport time is equal to the expected time with an increase of 20%, plus 5 seconds.

At the end of the operations, close the box cover using the appropriate screws.

8.4 Scheduled service

In order to maintain the efficiency of the aspirating smoke detection system, it is recommended to carry out a series of checks and service operations every six months.

The frequency of these maintenance sessions must be increased in the case of installations in dusty environments, with frequent changes in temperature or with a high level of humidity.

Scheduled service involves the operations described below (possibly in the order indicated):

- Make sure the operations on the FA100 aspirating system described below do not lead to any false alarm/fault signals on the fire detection system (activation of visual/audible alarms, blocking, etc.)
- Check for any active alarm or fault signals on the FA100 interface that are reported on the fire control panel.
- Check the functioning of the signalling LEDs on the front of the FA100 (long press the "OK" button).
- Check the events log for any alarm or fault messages. It is also recommended to read the historical data (data log) with the FA/STUDIO software to check for any critical issues (obscuration or flow values close to the alarm/fault thresholds).
- Remove the power-supply of the FA100 device.
- Clean any dust filters and discharge any condensate traps present in the aspiration system.
- Remove detection modules from their housings; remove and clean the filter meshes (refer to "*Cleaning of the FAD100FILTER filter meshes*").
- Clean the pipes by connecting an aspirator to the system through inspectable joints or suitably positioned three-way valves. If these parts are not present in the system, it is possible to draw air through the inlet manifold of the FA100 device with the detector modules removed.
- Reassemble the meshes and then insert the detector modules back into their housings. If the second detector module is not being used, check that the removable caps are inserted securely.
- Switch on the FA100 device, wait 15 minutes for the detector modules to complete initialisation, then proceed with the auto-calibration process of the nominal air flow and the functionality checks as described in the paragraphs relating to commissioning.

If it is necessary to carry out "fire tests", the filter meshes must be cleaned once the tests of each sensitivity class have been executed.

8.4.1 Cleaning of the FAD100FILTER filter meshes

The complete cleaning of the filter meshes requires their removal from the housing.

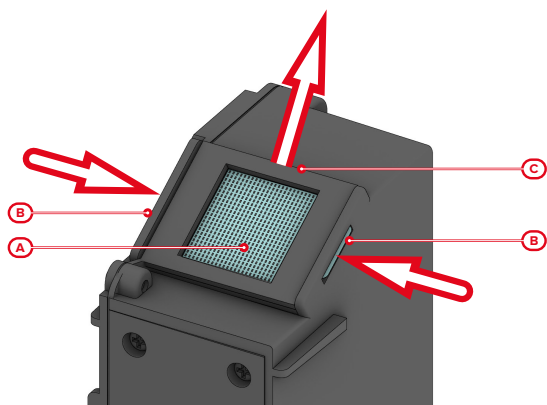

The removal of the FAD100FILTER filter meshes ([A]) must be carried out by pressing on their tabs ([B]) and by unthreading through the appropriate opening ([C]).

For the cleaning process, the use of cans of "compressed air" normally used for cleaning electronic devices is recommended. It is recommended to hold the can nozzle approximately 5cm from the mesh.

If necessary, use a clean brush with soft bristles.

If it is not possible to clean the filters completely or if they are damaged, replace them.

A high quantity of dust or dirt on the meshes, or the presence of a contamination fault, suggests the need to clean the interior of the detector module (sampling chamber).





For this kind of intervention also, the use of cans of "compressed air" is recommended. Holding the can nozzle approximately 5cm from the inlet/outlet vents, spray air into the detector module.





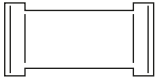

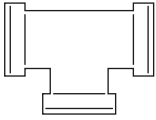
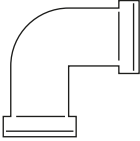
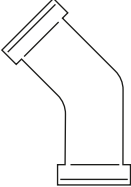
Appendix A Accessories

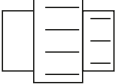
Accessories for FA100

Code	description
FAD100	Detector module
FAD100FILTER	Metal mesh with gasket
FA100-WIFI	Wi-Fi interface module

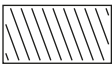
Accessories for aspirating systems

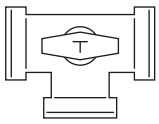
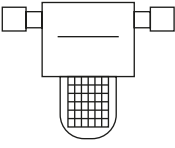
Code	description	dimensions	package
TUBOABS0250M	 Pipe	internal Ø 21mm external Ø 25mm 3m bar	25 bars
SASO100250RS	 Coupling sleeve	for Ø 25mm pipe	packs of 10
SATE400250RS	 T-piece	for Ø 25mm pipe	packs of 10
SABE300250RS	 90° bend external Ø 25 mm	for Ø 25mm pipe (large radius)	packs of 10
SAEY500250RS	 45° Elbow	for Ø 25mm pipe	packs of 10
SACA700250RS	 Pipe end cap	for Ø 25mm pipe	packs of 10
SAUN800250RS	 Openable joint sleeve	for Ø 25mm pipe	packs of 10

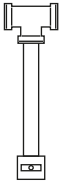
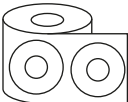
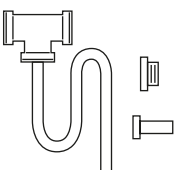
Code		description	dimensions	package
STS25REDK		Hose clip	for Ø 25mm pipe	packs of 50
SGLUEN0250		Sealing glue	-	250ml
SGLUEN0500		Sealing glue	-	500ml
17250019050		Flexible transparent spiral pipe	external Ø 25mm	10mt roll
MPE1008025M-R		Red flexible pipe for sampling capillaries	external Ø 10mm	25Mt roll
2510025		3-way pvc/epdm ball valve for pipes	for Ø 25mm pipe	-
504F075ABS		F0.75 medium filter complete with RL5 cartridge	3/4"G threaded connections	-
AAD12025CRS		Male/Female fitting	from 3/4"G to 25 mm	-
WT025		Condensate trap for particularly cold environments	-	-
LABEL23X10		Sampling hole identification labels with written "ASPIRATING POINT"	-	200 pack roll
CAPKIT2510SR		Kit for the creation of a sampling capillary comprising:	-	-

Code	description	dimensions	package
	T-piece	for Ø 25mm pipe with Ø 10mm pipe outlet	
	1 bulkhead	from 3/8"G to 28mm 35mm length for Ø 10mm pipe	
	1 gasket	3/8"G	

Appendix B Pre-calculated installations

The installer can use the tables provided below to design aspirator pipe systems without using the FA/STUDIO software.

These are standard type systems, to be considered as a subset of the various possible systems and equally programmable via software.

Tables

These systems are grouped in the following tables provided, which differ from each other by detection class, number of detector modules used and use of dust filter or condensate traps:

Table	detection class	number of detectors	anti-dust filter	condensation trap
A1	A	1	No	No
A2	A	2	No	No
B1	B	1	No	No
B2	B	2	No	No
C1	C	1	No	No
C2	C	2	No	No
A1_DF	A	1	Yes	No
A2_DF	A	2	Yes	No
B1_DF	B	1	Yes	No
B2_DF	B	2	Yes	No
C1_DF	C	1	Yes	No
C2_DF	C	2	Yes	No
A1_CT	A	1	No	Yes
A2_CT	A	2	No	Yes
B1_CT	B	1	No	Yes
B2_CT	B	2	No	Yes
C1_CT	C	1	No	Yes
C2_CT	C	2	No	Yes
A1_DF_CT	A	1	Yes	Yes
A2_DF_CT	A	2	Yes	Yes
B1_DF_CT	B	1	Yes	Yes
B2_DF_CT	B	2	Yes	Yes
C1_DF_CT	C	1	Yes	Yes
C2_DF_CT	C	2	Yes	Yes

Once the table for the type of system to be configured has been identified, based on the construction needs (number of branches, length of branches or number of holes for each branch, the table provides pre-calculated programming data, to be entered via the device programming menu.

The tables show, distributed over the rows, the number of branches and their lengths, divided by intervals. "Length" is the distance the air drawn into the pipe travels from the most distant hole to the detector.

The columns show the required number of holes for each branch. The holes are numbered from the nearest (hole #1) to the furthest (hole with maximum number) from the detector.

Parameters

In the boxes at the intersection of number/length of branches and number of holes are the programming parameters to be used:

- Holes diameter, in mm ("Ø")
- Detection sensitivity (depending on sampling hole balance, "S")
- Aspiration speed, in RPM (fan revolutions per minute, "V")
- Expected airflow, in l/min ("F")
- Balancing of the air aspiration between the holes ("B")
- Transit time of the smoke from the most distant hole to the detector ("T")
The calculation of this parameter is based on the length of the branches. Since the length is indicated in the table as a range, the calculation is carried out using the average length.

These parameters, in addition to the length of the branches and the total length of the piping, determine the validity of the system for the selected sensitivity class.

Conditions of use

The use of these tables requires the following constraints to be satisfied:

- The pipe system connected to the detector is considered as divided into 1, 2 or 4 branches.
- All the branches into which the installation is divided are equal to each other in terms of length and number of holes.
"Branch length" stands for the distance from the fork (T fitting) to the last hole (farthest from the FA100 device).
- The sampling holes must be equidistant from each other (with a 10% tolerance).
- For each pipe line only one dust filter may be used, this must be positioned upstream of the detector and downstream of any sampling holes.
- For each line only one condensate trap may be used, this must be positioned upstream of the detector and downstream of any sampling hole.
- The length of the drain piping should not exceed 3 meters.
- If both FAD100 detector modules are used for only one FA100, both pipes must have the same class, same filter and condensate trap, the same number of branches, length and number of holes.
The sampling holes must be equidistant from each other (with a maximum tolerance of 10%).
- The distance between the FA100 device and a T fitting must be at most 10% of the branch length.
- The ambient temperature must be between 10 and 40°C.

Design constraints

The details of the project design constraints that must be respected are provided in the following table:

Constraint	detection class		
	A	B	C
Number of pipe branches for one channel, topology of the pipe system (min & max)	1; 2; 4	1; 2; 4	1; 2; 4
Number of pipe branches for all channels, topology of the pipe system (min & max)	2; 4; 8	2; 4; 8	2; 4; 8
Maximum linear pipe length for one channel pipe system	100m	100m	100m
Maximum overall branch pipe length for one channel pipe system	160m	160m	160m
Maximum linear pipe length for all channels pipe system	100m	100m	100m
Maximum overall branch pipe length for all channels pipe system	160m	160m	160m
Minimum number of sampling holes for one channel pipe system (linear & branch pipe)	1	1	1
Maximum number of sampling holes for one channel pipe system (linear & branch pipe)	8	18	51
Minimum number of sampling holes for all channels pipe system (linear & branch pipe)	2	2	2
Maximum number of sampling holes for all channels pipe system (linear & branch pipe)	16	36	102
Minimum number of sampling holes per branch layout	1	1	1
Maximum number of sampling holes per branch layout	8	18	51
Maximum distance of the farthest hole from the FA100	100m	100m	100m
Distance between the FA100 and 1st hole (min)	0.25m	0.25m	0.25m
Distance between the FA100 and 1st hole (max)	100m	100m	100m
Distance between the two sampling holes (min)	0.10m	0.10m	0.10m
Number of dust filters (504F075ABS) per pipe network (max)	1	1	1
Number of water traps (WT025) per pipe network (max)	1	1	1
Maximum number of dust filters & water traps per pipe network	2	2	2
Distance between FA100 & filter / water trap (max)	2m	2m	2m
Distance between filter & water trap (min)	0	0	0
Transport time (min & max)	0 – 85s	0 – 85s	0 – 85s
System balance (min & max %)	72.7 – 100%	69.4 – 100%	59.5 – 100%
Exhaust pipe length (min & max)	0.5 – 10m	0.5 – 10m	0.5 – 10m
Fan speed	2500 RPM (default)		

Constraint	detection class		
	A	B	C
	1500 – 4750 RPM (range, in steps of 250 RPM)		
Pipe diameter	internal 21mm external 25mm		
Capillary tube max length	2m		
Diameter of sampling holes on standard pipe	0; 2; 2.5; 3.0; 3.5; 4.0; 4.5; 5.0; 5.5; 6.0; 6.5; 7.0; 7.5; 8.0; 10.0 (mm)		
Diameter of sampling holes on capillary	0; 2; 2.5; 3.0; 3.5; 4.0; 4.5; 5.0; 5.5; 6.0; 6.5; 7.0; 7.5; 8.0 (mm)		

Table A1

Detection class	A
Number of detectors	1
Anti-dust filter	No
Condensation trap	No

D1 | detector 1 module

Øn	diameter of the hole "n" (mm)
S	detection sensitivity (10 ⁻⁵ dB/m)
V	aspiration speed (RPM)
F	expected airflow (l/min)
B	air aspiration balancing between the holes (%)
T	transit time of the smoke (s)

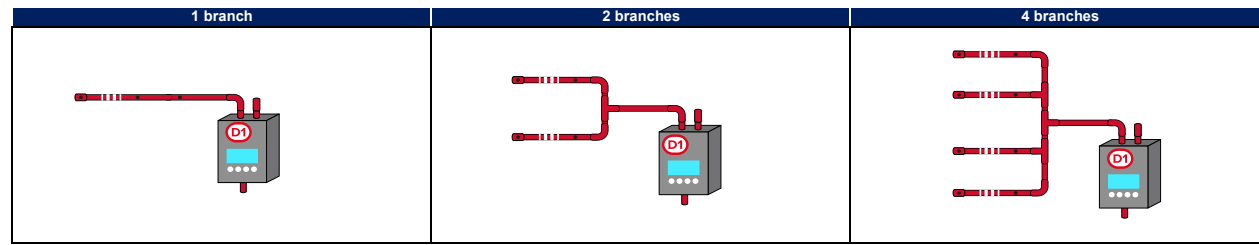

Number of branches	Length of branches (m)	parameters	Number of holes for each branch							
			1	2	3	4	5	6	7	8
1	60 ÷ 90	Ø	Ø 1: 10	Ø 1: 5 Ø 2: 10	Ø 1: 3.5 Ø 2: 4 Ø 3: 5.5	Ø 1: 3.5 Ø 2: 3: 4 Ø 4: 6	Ø 1: 3.5 Ø 2: 4 Ø 3: 4.5 Ø 4: 5 Ø 5: 7.5	Ø 1: 3 Ø 2: 3: 3.5 Ø 4: 5: 4 Ø 6: 5.5	Ø 1: 3 Ø 2: 3: 3.5 Ø 4: 5: 4 Ø 6: 4.5 Ø 7: 5.5	
		S	2500	903	641	476	421	343	302	
		V	3000	3000	3500	3750	4000	4250	4500	
		F	23.6	30	31.8	37.4	44.6	50.1	53	
		B	100	60	57	53	62	58	69	
		T	57	59	64	62	60	56	61	
1	30 ÷ 60	Ø	Ø 1: 10	Ø 1: 5.5 Ø 2: 10	Ø 1: 4 Ø 2: 4.5 Ø 3: 6	Ø 1.2: 4 Ø 3: 4.5 Ø 4: 6	Ø 1.3: 3.5 Ø 4: 4 Ø 5: 5	Ø 1.2: 3 Ø 3.5: 3.5 Ø 6: 4.5	Ø 1: 3 Ø 2.4: 3.5 Ø 5.6: 4 Ø 7: 4.5	Ø 1.2: 3 Ø 3.5: 3.5 Ø 6.8: 4
		S	2500	854	650	493	397	334	300	260
		V	2000	2200	2250	2250	2500	2500	2750	3250
		F	17.1	22.2	23.9	27.7	30.7	30.3	37.4	44.2
		B	100	68	66	63	59	60	75	83
		T	47	49	53	53	51	55	52	49
1	15 ÷ 30	Ø	Ø 1: 5	Ø 1: 3.5 Ø 2: 4.5	Ø 1.2: 3.5 Ø 3: 4.5	Ø 1.3: 3 Ø 4: 4	Ø 1.4: 3 Ø 5: 4	Ø 1.5: 3 Ø 6: 4	Ø 1.6: 3 Ø 7: 3.5	Ø 1.8: 2.5
		S	2500	976	685	510	412	344	311	296
		V	1500	1500	1500	1500	1500	1500	1500	2000
		F	7.2	9.6	12.8	12.6	14.8	16.9	18.2	20.4
		B	100	66	64	58	58	58	75	87
		T	56	56	50	56	52	50	55	56
2	30 ÷ 60	Ø	Ø 1: 10	Ø 1: 4.5 Ø 2: 7	Ø 1.2: 4 Ø 3: 5.5	Ø 1: 3.5 Ø 2: 3: 4 Ø 4: 4.5				
		S	1250	427	325	267				
		V	2000	2250	2500	2750				
		F	31.7	39.7	46.8	55.4				
		B	100	59	61	81				
		T	51	53	55	57				
2	15 ÷ 30	Ø	Ø 1: 5	Ø 1: 3.5 Ø 2: 4.5	Ø 1.2: 3.5 Ø 3: 4.5	Ø 1.3: 3.5 Ø 4: 4				
		S	1250	488	343	278				
		V	1500	1500	1500	1500				
		F	14.3	18.6	24.2	27.8				
		B	100	66	65	80				
		T	57	58	53	58				
4	20 ÷ 40	Ø	Ø 1: 6	Ø 1: 3.5 Ø 2: 4						
		S	625	277						
		V	1750	2500						
		F	37.4	52.1						
		B	100	81						
		T	58	58						
4	5 ÷ 20	Ø	Ø 1: 4	Ø 1: 3 Ø 2: 3.5						
		S	625	266						
		V	1500	1500						
		F	20.2	26.2						
		B	100	76						
		T	44	47						

Table A2

Detection class	A
Number of detectors	2
Anti-dust filter	No
Condensation trap	No

D1	detector 1 module
D2	detector 2 module
$\emptyset n$	diameter of the hole "n" (mm)
S	detection sensitivity (10^{-5} dB/m)
V	aspiration speed (RPM)
F	expected airflow (l/min)
B	air aspiration balancing between the holes (%)
T	transit time of the smoke (s)

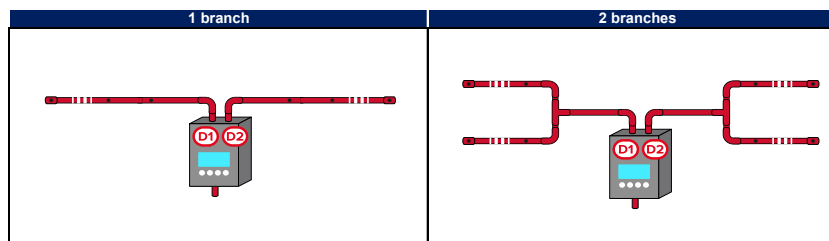

Number of branches	Length of branches (m)	parameters	Number of holes for each branch							
			1	2	3	4	5	6	7	8
1	30 ÷ 60	\emptyset	\emptyset 1: 10	\emptyset 1: 4.5 \emptyset 2: 7	\emptyset 1,2: 4 \emptyset 3: 5.5	\emptyset 1: 3.5 \emptyset 2,3: 4 \emptyset 4: 5.5	\emptyset 1,2: 3 \emptyset 3,4: 3.5 \emptyset 5: 4.5	\emptyset 1,2: 3 \emptyset 3,5: 3.5 \emptyset 6: 4.5	\emptyset 1: 3 \emptyset 2,5: 3,5 \emptyset 6: 4 \emptyset 7: 4,5	\emptyset 1,2: 3 \emptyset 3,5: 3,5 \emptyset 6,8: 4
		S	2500	854	650	490	384	334	298	266
		V	2000	2250	2500	2500	2750	2750	3000	3250
		F	31.7	39.7	46.8	52	54.5	60.6	71.3	78.8
		B	100	59	61	60	56	60	69	81
		T	51	53	55	55	55	55	54	56
1	10 ÷ 30	\emptyset	\emptyset 1: 5	\emptyset 1: 3.5 \emptyset 2: 4.5	\emptyset 1,2: 3,5 \emptyset 3: 4,5	\emptyset 1,3: 3 \emptyset 4: 4	\emptyset 1,4: 3 \emptyset 5: 4	\emptyset 1,4: 2,5 \emptyset 5: 3 \emptyset 6: 3,5	\emptyset 1,6: 2,5 \emptyset 7: 3	\emptyset 1,8: 2,5
		S	2500	964	684	512	414	334	322	298
		V	1500	1500	1500	1500	1500	1750	2000	2250
		F	14.6	18.9	24.7	24.4	28.1	30.8	36.2	43.5
		B	100	65	64	58	58	53	70	89
		T	49	50	46	51	49	45	46	47
2	20 ÷ 40	\emptyset	\emptyset 1: 6	\emptyset 1: 3,5 \emptyset 2: 4,5	\emptyset 1,2: 3 \emptyset 3: 4	\emptyset 1,4: 2,5				
		S	1250	488	332	306				
		V	1750	2250	2500	3750				
		F	37.4	50.5	59.3	74.9				
		B	100	66	59	96				
		T	58	57	56	61				
2	5 ÷ 20	\emptyset	\emptyset 1: 4	\emptyset 1: 2,5 \emptyset 2: 3,5	\emptyset 1,2: 2,5 \emptyset 3: 3	\emptyset 1,4: 2,5				
		S	1250	426	364	308				
		V	1500	1500	1750	2000				
		F	20.2	23.3	31.3	40.6				
		B	100	52	70	97				
		T	44	49	46	47				

Table C1, holes from 37 to 44

Detection class	C
Number of detectors	1
Anti-dust filter	No
Condensation trap	No

D1 | detector 1 module

Øn	diameter of the hole "n" (mm)
S	detection sensitivity (10 ⁻⁵ dB/m)
V	aspiration speed (RPM)
F	expected airflow (l/min)
B	air aspiration balancing between the holes (%)
T	transit time of the smoke (s)

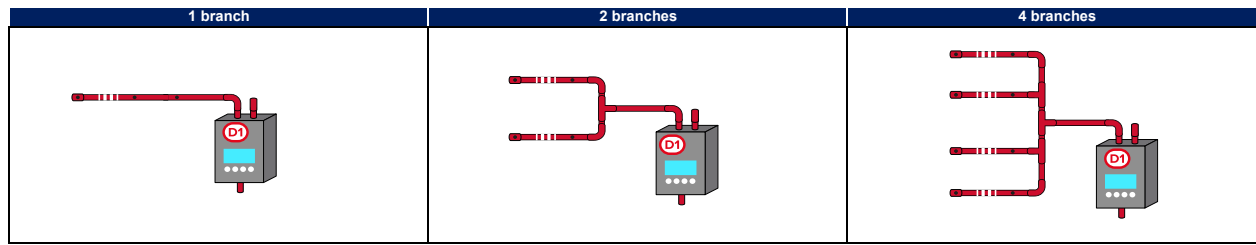

Number of branches	Length of branches (m)	parameters	Number of holes for each branch								
			37	38	39	40	41	42	43	44	
1	60 ÷ 90	Ø									
		S									
		V									
		F									
		B									
		T									
1	30 ÷ 60	Ø									
		S									
		V									
		F									
		B									
		T									
1	15 ÷ 30	Ø	Ø 1..37: 2	Ø 1..38: 2	Ø 1..39: 2	Ø 1..39: 2 Ø 40: 2.5	Ø 1..40: 2 Ø 41: 2.5	Ø 1..42: 2	Ø 1..42: 2 Ø 43: 2.5	Ø 1..21: 2 Ø 22..44: 2.5	
		S	429	416	414	388	377	375	358	348	
		V	2250	2250	2750	3250	3500	4000	4500	4250	
		F	46.3	48.4	61.1	69.6	75.9	87.9	100.5	98.6	
		B	54	55	57	52	51	52	51	52	
		T	45	44	34	26	24	25	19	21	

Table C2, holes from 19 to 26

Detection class	C
Number of detectors	2
Anti-dust filter	No
Condensation trap	No

D1	detector 1 module
D2	detector 2 module

Øn	diameter of the hole "n" (mm)
S	detection sensitivity (10 ⁻⁵ dB/m)
V	aspiration speed (RPM)
F	expected airflow (l/min)
B	air aspiration balancing between the holes (%)
T	transit time of the smoke (s)

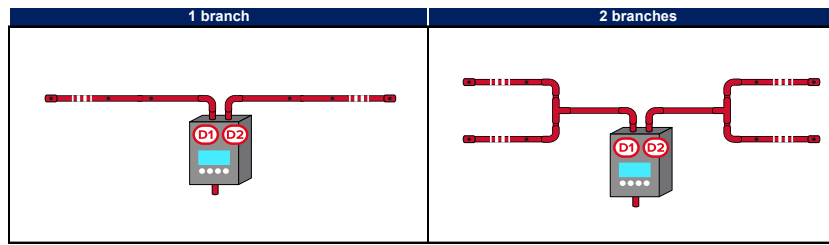

Number of branches	Length of branches (m)	parameters	Number of holes for each branch								
			19	20	21	22	23	24	25	26	
1	30 ÷ 60	Ø	Ø 1..12: 2 Ø 13..18: 2.5 Ø 19: 3	Ø 1..13: 2 Ø 14..19: 2.5 Ø 20: 3	Ø 1..14: 2 Ø 15..20: 2.5 Ø 21: 3	Ø 1..15: 2 Ø 16..21: 2.5 Ø 22: 3	Ø 1..22: 2 Ø 23: 2.5	Ø 1..23: 2 Ø 24: 2.5	Ø 1..24: 2 Ø 25: 2.5	Ø 1..25: 2 Ø 26: 2.5	
		S	782	740	696	662	710	670	638	610	
		V	3750	3750	3750	4000	4250	4250	4250	4250	4750
		F	92.1	93.7	94.9	102.6	107.1	108.6	110.3	125.3	
		B	50	50	50	50	60	58	56	55	
		T	53	55	55	51	56	56	57	51	
1	10 ÷ 30	Ø	Ø 1..19: 2	Ø 1..20: 2							
		S	996	942							
		V	3750	4250							
		F	95.3	111.0							
		B	84	83							
		T	28	25							

Table A1_DF

Detection class	A
Number of detectors	1
Anti-dust filter	Yes
Condensation trap	No

D1	detector 1 module
DF	filter for dust

Øn	diameter of the hole "n" (mm)
S	detection sensitivity (10 ⁻⁵ dB/m)
V	aspiration speed (RPM)
F	expected airflow (l/min)
B	air aspiration balancing between the holes (%)
T	transit time of the smoke (s)

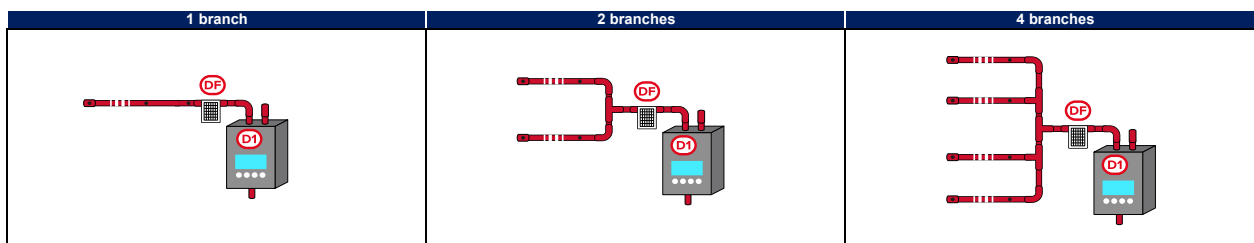

Number of branches	Length of branches (m)	parameters	Number of holes for each branch							
			1	2	3	4	5	6	7	8
1	60 ÷ 90	Ø	Ø 1: 10	Ø 1: 4.5 Ø 2: 7.5	Ø 1: 4 Ø 2: 4.5 Ø 3: 7	Ø 1.2: 4 Ø 3: 4.5 Ø 4: 7	Ø 1.2: 3.5 Ø 3: 4 Ø 4: 4.5 Ø 5: 6	Ø 1: 3 Ø 2: 3.5 Ø 3.4: 4 Ø 5: 4.5 Ø 6: 6	Ø 1: 3 Ø 2.3: 3.5 Ø 4.5: 4 Ø 6: 4.5 Ø 7: 5.5	
		S	2500	856	641	479	381	352	302	
		V	3000	3250	3750	3750	4250	4250	4750	
		F	22.8	28.8	34.1	38.2	43.7	46	53.5	
		B	100	58	57	55	58	62	69	
		T	59	60	60	62	61	62	60	
1	30 ÷ 60	Ø	Ø 1: 10	Ø 1: 4.5 Ø 2: 6.5	Ø 1: 4 Ø 2: 4.5 Ø 3: 6.5	Ø 1: 4 Ø 2: 4.5 Ø 3: 5.5 Ø 4: 8	Ø 1.2: 3 Ø 3.4: 3.5 Ø 5: 4.5	Ø 1.2: 3 Ø 3.5: 3.5 Ø 6: 4.5	Ø 1.3: 3 Ø 4.6: 3.5 Ø 7: 4	Ø 1.2: 3 Ø 3.5: 3.5 Ø 6.8: 4
		S	2500	915	623	491	382	331	295	264
		V	2000	2250	2250	2250	2750	2750	3000	3250
		F	16.4	19.9	23.4	28.5	28.5	30.7	35.5	43.4
		B	100	64	61	64	55	61	71	82
		T	49	54	53	50	53	55	54	50
1	15 ÷ 30	Ø	Ø 1: 5	Ø 1: 3.5 Ø 2: 4.5	Ø 1.2: 3.5 Ø 3: 4.5	Ø 1.3: 3 Ø 4: 4	Ø 1.4: 3 Ø 5: 4	Ø 1.5: 3 Ø 6: 4	Ø 1.3: 3 Ø 4.6: 3.5 Ø 7: 4	Ø 1.8: 2.5
		S	2500	976	685	510	411	342	295	296
		V	1500	1500	1500	1500	1500	1500	1500	2000
		F	7.2	9.4	12.4	12.2	14.3	16.1	18.9	19.7
		B	100	66	65	58	58	58	70	87
		T	56	57	52	58	55	53	50	58
2	30 ÷ 60	Ø	Ø 1: 7.5	Ø 1: 4 Ø 2: 6	Ø 1: 4 Ø 2: 4.5 Ø 3: 6	Ø 1: 4 Ø 2: 4.5 Ø 3: 5 Ø 4: 5.5				
		S	1250	427	327	270				
		V	2250	2500	2750	3000				
		F	29.3	36.1	48.2	59.2				
		B	100	56	66	89				
		T	55	58	53	55				
2	15 ÷ 30	Ø	Ø 1: 5	Ø 1: 3.5 Ø 2: 5	Ø 1.2: 3.5 Ø 3: 4.5	Ø 1: 4 Ø 2: 4.5 Ø 3: 5 Ø 4: 5.5				
		S	1250	433	343	270				
		V	1500	1500	1500	1500				
		F	13.8	19	22.1	29.9				
		B	100	55	65	89				
		T	59	54	59	54				
4	20 ÷ 40	Ø	Ø 1: 6	Ø 1: 4.5 Ø 2: 5.5						
		S	625	268						
		V	2000	2500						
		F	37.2	55.9						
		B	100	80						
		T	58	54						
4	5 ÷ 20	Ø	Ø 1: 4	Ø 1: 3.5 Ø 2: 4						
		S	625	274						
		V	1500	1500						
		F	19	28.1						
		B	100	80						
		T	47	45						

Table A2_DF

Detection class	A
Number of detectors	2
Anti-dust filter	Yes
Condensation trap	No

D1	detector 1 module
D2	detector 2 module
DF	filter for dust
$\emptyset n$	diameter of the hole "n" (mm)
S	detection sensitivity (10^{-5} dB/m)
V	aspiration speed (RPM)
F	expected airflow (l/min)
B	air aspiration balancing between the holes (%)
T	transit time of the smoke (s)

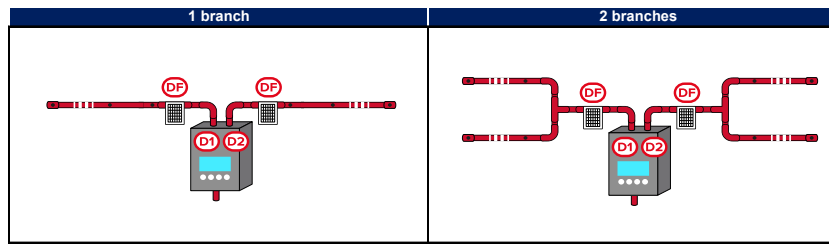

Number of branches	Length of branches (m)	parameters	Number of holes for each branch							
			1	2	3	4	5	6	7	8
1	30 ÷ 60	\emptyset	\emptyset 1: 10	\emptyset 1: 4.5 \emptyset 2: 7	\emptyset 1: 4 \emptyset 2: 4.5 \emptyset 3: 6	\emptyset 1..3: 3.5 \emptyset 4: 5	\emptyset 1..3: 3.5 \emptyset 4: 4 \emptyset 5: 5	\emptyset 1: 3 \emptyset 2..4: 3.5 \emptyset 5: 4 \emptyset 6: 5	\emptyset 1..2: 3 \emptyset 3..6: 3.5 \emptyset 7: 4	\emptyset 1..2: 3 \emptyset 3..5: 3.5 \emptyset 6..8: 4
		S	2500	860	654	478	398	332	300	266
		V	2000	2250	2500	2750	2750	2750	3250	3500
		F	30.6	38.3	47.7	51.6	58.2	60.9	71.2	81.1
		B	100	60	66	53	59	58	78	80
1	10 ÷ 30	T	53	55	54	54	54	54	56	54
		\emptyset	\emptyset 1: 5	\emptyset 1: 3.5 \emptyset 2: 4.5	\emptyset 1..2: 3.5 \emptyset 3: 4.5	\emptyset 1..3: 3.5 \emptyset 4: 4.5	\emptyset 1..4: 3 \emptyset 5: 4	\emptyset 1..5: 3 \emptyset 6: 4	\emptyset 1..6: 2.5 \emptyset 7: 3	\emptyset 1..8: 2.5
		S	2500	964	684	518	412	344	322	298
		V	1500	1500	1500	1500	1500	1500	2000	2250
		F	14.4	18.6	24.1	28.5	27.2	30.2	35.1	42.1
2	20 ÷ 40	B	100	66	64	64	58	58	70	89
		T	50	51	47	46	51	50	47	48
		\emptyset	\emptyset 1: 5.5	\emptyset 1: 3.5 \emptyset 2: 4.5	\emptyset 1..2: 3 \emptyset 3: 4	\emptyset 1..4: 3				
		S	1250	490	332	302				
		V	2000	2250	2500	3250				
2	5 ÷ 20	F	38.4	48.2	56.4	78.2				
		B	100	66	59	92				
		T	56	60	59	59				
		\emptyset	\emptyset 1: 4	\emptyset 1: 2.5 \emptyset 2: 3.5	\emptyset 1..2: 2.5 \emptyset 3: 3	\emptyset 1..4: 2.5				
		S	1250	426	364	308				
2	5 ÷ 20	V	1500	1500	1750	2000				
		F	19.9	22.8	30.4	39.2				
		B	100	53	70	97				
		T	45	50	48	48				

Table C1_DF, holes from 1 to 18

Detection class	C
Number of detectors	1
Anti-dust filter	Yes
Condensation trap	No

D1	detector 1 module
DF	filter for dust
Øn	diameter of the hole "n" (mm)
S	detection sensitivity (10 ⁻⁵ dB/m)
V	aspiration speed (RPM)
F	expected airflow (l/min)
B	air aspiration balancing between the holes (%)
T	transit time of the smoke (s)

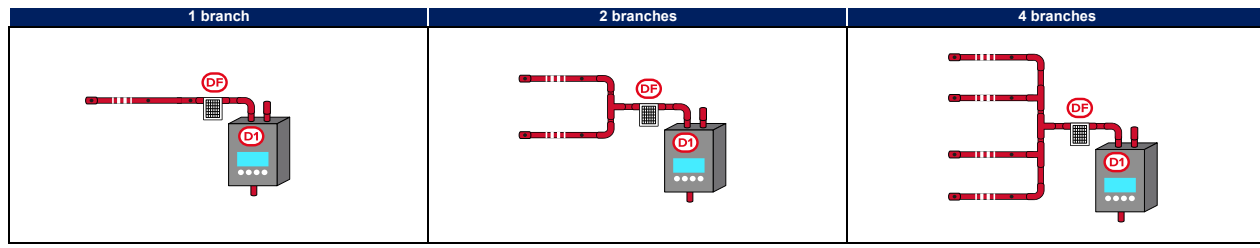

Number of branches	Length of branches (m)	parameters	Number of holes for each branch																			
			1	2	3	4	5	6	7	8	9	10	11	12	13	14	15	16	17	18		
1	60 ÷ 90	Ø	Ø 1: 10	Ø 1: 4.5 Ø 2: 7.5	Ø 1: 4 Ø 2: 4.5 Ø 3: 7.5	Ø 1: 3.5 Ø 2: 4 Ø 3: 4.5 Ø 4: 7	Ø 1.2: 3.5 Ø 3: 4 Ø 4: 4.5 Ø 5: 7	Ø 1: 2.5 Ø 2.4: 3 Ø 5: 3.5 Ø 6: 4.5	Ø 1: 2.5 Ø 2.3: 3 Ø 4.6: 3.5 Ø 7: 5	Ø 1: 2.5 Ø 2.4: 3 Ø 5.7: 3.5 Ø 8: 5	Ø 1.2: 2.5 Ø 2.3: 3 Ø 4.5: 3.5 Ø 6: 4 Ø 7: 4.5 Ø 8: 5 Ø 9: 7.5	Ø 1.3: 2.5 Ø 4.7: 3 Ø 8.9: 3.5 Ø 10: 4.5		Ø 1: 2 Ø 2.7: 2.5 Ø 8.11: 3 Ø 12: 4		Ø 1.2: 2 Ø 3.7: 2.5 Ø 8.11: 3 Ø 12.13: 3.5 Ø 14: 4.5						
		S	20000	6845	4928	3936	2982	2463	2166	1978	1757	1612		1276		1089						
		V	3000	3250	3500	3750	3750	4250	4500	4250	4500	4500	4750		4750		4750					
		F	22.8	28.8	33.0	37.2	40.7	39.3	45.9	45.3	51.9	56.8		52.6		55.3						
		B	100	58	54	54	53	50	51	53	55	53		50		51						
T	59	60	62	60	61	67	62	67	61	58		67		66								
1	30 ÷ 60	Ø	Ø 1: 10	Ø 1: 4 Ø 2: 6.5	Ø 1: 4 Ø 2: 4.5 Ø 3: 6.5	Ø 1: 4 Ø 2: 4.5 Ø 4: 8	Ø 1: 3 Ø 2.4: 3.5 Ø 5: 5	Ø 1.2: 3 Ø 3.5: 3.5 Ø 6: 5	Ø 1.3: 3 Ø 4.6: 3.5 Ø 7: 5	Ø 1.3: 2.5 Ø 4.7: 3 Ø 8: 4	Ø 1.3: 2.5 Ø 3.7: 3 Ø 4.8: 3 Ø 9: 4	Ø 1.2: 2.5 Ø 3.7: 3 Ø 8.9: 3.5 Ø 10: 4.5	Ø 1.5: 2.5 Ø 6.10: 3 Ø 11: 4	Ø 1.6: 2.5 Ø 7.11: 3 Ø 12: 4	Ø 1.7: 2.5 Ø 8.12: 3 Ø 13: 4	Ø 1.8: 2 Ø 9.13: 2.5 Ø 14: 3	Ø 1.9: 2 Ø 10.14: 2.5 Ø 15: 3	Ø 1.9: 2 Ø 10.15: 2.5 Ø 16: 3	Ø 1.10: 2 Ø 11.16: 2.5 Ø 17: 3	Ø 1.11: 2 Ø 12.17: 2.5 Ø 18: 3		
		S	20000	6244	4981	3932	2999	2580	2214	1892	1730	1566	1406	1293	1186	1085	1019	948	894	842		
		V	2000	2250	2250	2250	2500	2500	2500	2750	2750	2750	3000	3000	3000	3000	3250	3250	3250	3250	3250	
		F	16.4	18.8	23.4	28.2	27.1	29.2	31.1	31.4	32.4	35.6	37.9	39.5	39.7	37.6	38.4	40.4	40.6	41.6		
		B	100	50	61	57	53	52	51	50	53	52	51	51	51	50	50	51	51	51	51	
T	49	54	53	49	55	54	54	54	56	58	55	53	53	55	56	56	56	56	56			
1	15 ÷ 30	Ø	Ø 1: 5	Ø 1: 3 Ø 2: 4.5	Ø 1.2: 3 Ø 3: 4.5	Ø 1.3: 3 Ø 4: 4	Ø 1.4: 3 Ø 5: 4	Ø 1: 2.5 Ø 2.5: 3 Ø 6: 4	Ø 1: 2.5 Ø 2.6: 3 Ø 7: 4	Ø 1.7: 2.5 Ø 8: 3.5	Ø 1.8: 2.5 Ø 9: 3.5	Ø 1.9: 2.5 Ø 10: 3.5	Ø 1.10: 2.5 Ø 11: 3.5	Ø 1.11: 2.5 Ø 12: 3.5	Ø 1.12: 2.5 Ø 13: 3.5	Ø 1.10: 2.5 Ø 11.13: 3 Ø 14: 3.5	Ø 1: 2 Ø 2.11: 2.5 Ø 12.14: 3 Ø 15: 3.5	Ø 1.2: 2 Ø 3.12: 2.5 Ø 13.15: 3 Ø 16: 3.5	Ø 1.3: 2 Ø 4.13: 2.5 Ø 14.16: 3 Ø 17: 3.5	Ø 1.3: 2 Ø 4.14: 2.5 Ø 15.17: 3 Ø 18: 3.5		
		S	20000	6398	4743	4081	3291	2387	2107	2065	1830	1638	1478	1341	1224	1102	951	902	857	825		
		V	1500	1500	1500	1500	1500	1500	1500	1500	1500	1500	1500	1500	1500	1500	1500	1500	1500	1500	1500	
		F	7.2	8.6	10.9	12.2	14.3	15.4	17.1	15.3	16.5	17.7	18.7	19.7	19.7	20.6	22.1	22.3	22.6	22.9	23.5	
		B	100	49	47	58	58	50	53	52	52	52	52	52	52	52	57	56	56	55	56	
T	56	59	54	58	55	52	51	59	57	56	55	55	55	55	52	52	51	51	51	52		
2	30 ÷ 60	Ø	Ø 1: 7.5	Ø 1: 4 Ø 2: 6.5	Ø 1: 4 Ø 2: 4.5 Ø 3: 7	Ø 1: 3.5 Ø 2.3: 4 Ø 4: 6	Ø 1.4: 3 Ø 5: 4.5	Ø 1.2: 3 Ø 3.5: 3.5 Ø 6: 4 Ø 7: 5.5	Ø 1.3: 2.5 Ø 4.7: 3 Ø 8: 4	Ø 1.4: 2.5 Ø 5.8: 3 Ø 9: 4	Ø 1.4: 2.5 Ø 5.9: 3 Ø 10: 4	Ø 1.5: 2.5 Ø 4.8: 3 Ø 9.10: 3.5 Ø 11: 4.5	Ø 1.10: 2 Ø 11: 2.5 Ø 12: 3	Ø 1.7: 2 Ø 8.12: 2.5 Ø 13: 3	Ø 1.7: 2 Ø 8.13: 2.5 Ø 14: 3	Ø 1.9: 2 Ø 10.14: 2.5 Ø 15: 3	Ø 1.9: 2 Ø 10.15: 2.5 Ø 16: 3	Ø 1.9: 2 Ø 10.16: 2.5 Ø 17: 3	Ø 1.9: 2 Ø 11.17: 2.5 Ø 18: 3			
		S	10000	3135	2429	1899	1510	1282	1122	951	853	777	711	640	585	541	505	474	441	415		
		V	2250	2500	2500	2750	3000	3000	3000	3250	3250	3500	3500	3500	3750	4000	4000	4000	4000	4000	4250	
		F	29.3	37.5	44.3	50.5	50.1	57.4	61.2	61.2	63.2	69.7	72.3	66.0	74.6	76.0	77.6	79.8	80.0	86.6		
		B	100	50	56	52	47	52	50	50	50	52	52	45	50	50	50	51	51	50	51	
T	55	54	55	54	58	55	55	57	58	56	55	55	61	55	56	56	56	56	58	55		
2	15 ÷ 30	Ø	Ø 1: 5	Ø 1: 3.5 Ø 2: 5	Ø 1.2: 3 Ø 3: 4.5	Ø 1.3: 3 Ø 4: 4.5	Ø 1.4: 3 Ø 5: 4.5	Ø 1.2: 3 Ø 3.5: 3.5 Ø 6: 5	Ø 1.6: 2.5 Ø 7: 3.5	Ø 1.7: 2.5 Ø 8: 3.5	Ø 1.8: 2.5 Ø 9: 3.5	Ø 1.9: 2.5 Ø 10: 3.5	Ø 1.5: 2.5 Ø 6.10: 3 Ø 11: 4	Ø 1.6: 2.5 Ø 7.11: 3 Ø 12: 4	Ø 1.7: 2 Ø 8.12: 2.5 Ø 13: 3	Ø 1.7: 2 Ø 8.13: 2.5 Ø 14: 3	Ø 1.8: 2 Ø 9.14: 2.5 Ø 15: 3	Ø 1.9: 2 Ø 10.15: 2.5 Ø 16: 3	Ø 1.10: 2 Ø 11.16: 2.5 Ø 17: 3	Ø 1.11: 2 Ø 12.17: 2.5 Ø 18: 3		
		S	9999	3464	2374	1861	1511	1280	1182	1033	913	815	710	652	587	543	510	480	451	425		
		V	1500	1500	1500	1500	1500	1500	1750	1750	1750	1750	1750	1750	1750	2000	2000	2000	2000	2000	2000	
		F	13.8	19.0	19.9	22.9	25.3	29.0	28.7	30.7	32.3	33.8	36.9	37.6	38.7	40.1	40.9	41.6	42.3	42.9		
		B	100	55	48	47	47	52	52	52	52	52	52	51	51	50	51	51	51	51	51	
T	59	54	59	58	58	55	59	59	59	59	59	54	55	52	53	53	53	53	53	54		
4	20 ÷ 40	Ø	Ø 1: 6	Ø 1: 4 Ø 2: 6	Ø 1.2: 3 Ø 3: 4.5	Ø 1.2: 3 Ø 3: 3.5 Ø 4: 4.5	Ø 1.3: 3 Ø 4: 3.5 Ø 5: 4.5	Ø 1: 2.5 Ø 3.5: 3.5 Ø 6: 4	Ø 1.5: 2 Ø 7: 3	Ø 1.6: 2 Ø 8: 3	Ø 1.6: 2 Ø 7.8: 2.5 Ø 9: 3	Ø 1.6: 2 Ø 7.9: 2.5 Ø 10: 3	Ø 1.2: 2 Ø 3.10: 2.5 Ø 11: 3	Ø 1.11: 2 Ø 12: 2.5								
		S	5000	1709	1187	926	763	607	557	495	432	383	330	300	276							
		V	2000	2250	2500	2750	2750	3000	3250	3250	3500	3500	3500	3750	4250							
		F	37.2	49.6	51.9	63.1	65.9	72.2	67.5	70.5	79.8	83.0	83.0	94.3	101.3							
		B	100	56	48	51	51	52	46	46	45	48	48	57	64							
T	58	56	60	57	60	60	61	62	58	58	58	61	58									
4	5 ÷ 20	Ø	Ø 1: 4	Ø 1: 3 Ø 2: 4	Ø 1.2: 2.5 Ø 3: 3.5	Ø 1.3: 2.5 Ø 4: 3.5	Ø 1.4: 2.5 Ø 5: 3	Ø 1.5: 2 Ø 6: 2.5	Ø 1.6: 2 Ø 7: 2.5	Ø 1.7: 2 Ø 8: 2.5	Ø 1.8: 2 Ø 9: 2.5	Ø 1.9: 2 Ø 10: 2.5	Ø 1.11: 2	Ø 1.12: 2								
		S	5000	1820	1264	997	900	751	649	570	507	458	440	403								
		V	1500	1500	1500	1500	1750	2000	2000	2000	2000	2250	2500	2750								
		F	19.0	26.2	26.2	29.8	36.6	36.8	39.8	42.2	44.2	51.7	58.3	66.0								
		B	100	59	52	52	70	64	64	64	64	64	92	91								
T	47	44	50	50	49	50	50	49	49	49	44	48	44									

Table C1_DF, holes from 37 to 42

Detection class	C
Number of detectors	1
Anti-dust filter	Yes
Condensation trap	No

D1	detector 1 module
DF	filter for dust
$\emptyset n$	diameter of the hole "n" (mm)
S	detection sensitivity (10^{-5} dB/m)
V	aspiration speed (RPM)
F	expected airflow (l/min)
B	air aspiration balancing between the holes (%)
T	transit time of the smoke (s)

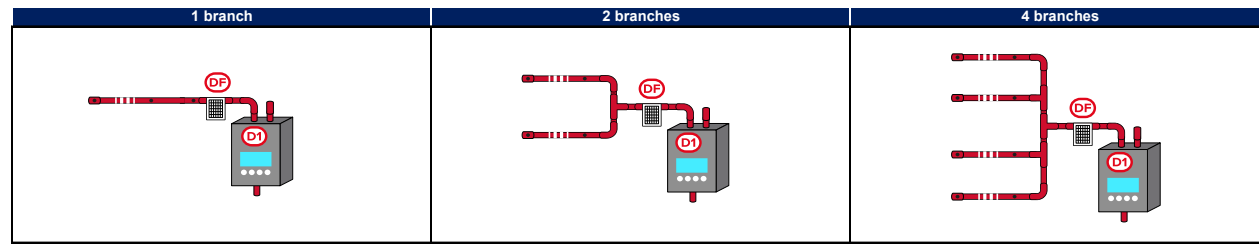

Number of branches	Length of branches (m)	parameters	Number of holes for each branch					
			37	38	39	40	41	42
1	60 ÷ 90	\emptyset						
		S						
		V						
		F						
		B						
		T						
1	30 ÷ 60	\emptyset						
		S						
		V						
		F						
		B						
		T						
1	15 ÷ 30	\emptyset	\emptyset 1.37: 2	\emptyset 1.38: 2	\emptyset 1.39: 2	\emptyset 1.40: 2	\emptyset 1.41: 2	\emptyset 1.41: 2 \emptyset 42: 2.5
		S	427	416	407	401	386	368
		V	2500	2750	3250	4500	4000	4500
		F	45.1	50.1	59.9	84.3	75.2	85.7
		B	54	53	53	54	52	51
		T	46	42	35	25	29	22

Table C2_DF, holes from 19 to 27

Detection class	C
Number of detectors	2
Anti-dust filter	Yes
Condensation trap	No

D1	detector 1 module
D2	detector 2 module
DF	filter for dust
Øn	diameter of the hole "n" (mm)
S	detection sensitivity (10 ⁻⁵ dB/m)
V	aspiration speed (RPM)
F	expected airflow (l/min)
B	air aspiration balancing between the holes (%)
T	transit time of the smoke (s)

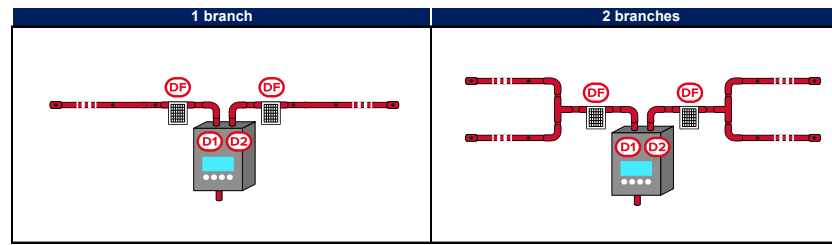

Number of branches	Length of branches (m)	parameters	Number of holes for each branch								
			19	20	21	22	23	24	25	26	27
1	30 ÷ 60	Ø	Ø 1..12: 2 Ø 13..18: 2.5 Ø 19: 3	Ø 1..6: 2 Ø 7..15: 2.5 Ø 16..19: 3 Ø 20: 3.5	Ø 1..14: 2 Ø 15..20: 2.5 Ø 21: 3	Ø 1..11: 2 Ø 12..21: 2.5 Ø 22: 3	Ø 1..22: 2 Ø 23: 2.5	Ø 1..16: 2 Ø 17..23: 2.5 Ø 24: 3	Ø 1..13: 2 Ø 14..24: 2.5 Ø 25: 3	Ø 1..25: 2 Ø 26: 2.5	Ø 1..26: 2 Ø 27: 2.5
		S	786	756	698	662	706	598	566	608	576
		V	3750	3750	4000	4000	4250	4250	4250	4750	4750
		F	87.8	92.0	96.1	97.4	101.3	105.9	106.8	118.2	119.4
		B	51	56	50	50	60	51	50	55	53
		T	57	55	54	56	59	53	55	54	55
1	10 ÷ 30	Ø	Ø 1..19: 2	Ø 1..20: 2	Ø 1..21: 2	Ø 1..22: 2	Ø 1..23: 2				
		S	982	932	886	844	806				
		V	2750	3000	3500	4000	4500				
		F	66.9	74.2	88.1	102.7	117.7				
		B	83	82	80	79	78				
		T	40	37	32	28	24				

Table A1_CT

Detection class	A
Number of detectors	1
Anti-dust filter	No
Condensation trap	Yes

D1	detector 1 module
CT	trap for condensation

Øn	diameter of the hole "n" (mm)
S	detection sensitivity (10 ⁻⁵ dB/m)
V	aspiration speed (RPM)
F	expected airflow (l/min)
B	air aspiration balancing between the holes (%)
T	transit time of the smoke (s)

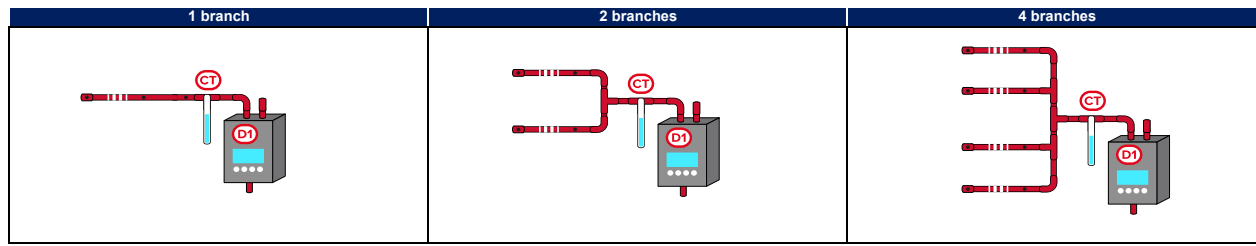

Number of branches	Length of branches (m)	parameters	Number of holes for each branch							
			1	2	3	4	5	6	7	8
1	60 ÷ 90	Ø	Ø 1: 10	Ø 1: 5 Ø 2: 10	Ø 1: 3.5 Ø 2: 4 Ø 3: 5.5	Ø 1: 3.5 Ø 2.3: 4 Ø 4: 6	Ø 1: 3.5 Ø 2: 4 Ø 3: 4.5 Ø 4: 5 Ø 5: 7.5	Ø 1: 3 Ø 2.3: 3.5 Ø 4.5: 4 Ø 6: 5.5	Ø 1: 3 Ø 2.3: 3.5 Ø 4.5: 4 Ø 6: 4.5 Ø 7: 5.5	
		S	2500	903	641	476	421	343	302	
		V	3000	3000	3500	3750	4000	4250	4500	
		F	23.6	29.9	31.7	37.3	44.5	47	52.9	
		B	100	60	57	53	62	59	69	
		T	57	59	64	62	61	60	61	
1	30 ÷ 60	Ø	Ø 1: 10	Ø 1: 5.5 Ø 2: 10	Ø 1: 4 Ø 2: 4.5 Ø 3: 6	Ø 1: 4 Ø 2: 4.5 Ø 3: 5 Ø 4: 7	Ø 1.3: 3.5 Ø 4: 4 Ø 5: 5	Ø 1: 3.5 Ø 2.3: 4 Ø 4: 4.5 Ø 5: 5 Ø 6: 6.5	Ø 1: 3 Ø 2.4: 3.5 Ø 5.6: 4 Ø 7: 4.5	Ø 1.2: 3 Ø 3.5: 3.5 Ø 6.8: 4
		S	2500	855	651	512	394	341	300	260
		V	2000	2000	2250	2250	2500	2500	2750	3250
		F	17.1	22.2	23.9	29.9	30.6	35.1	37.2	44.1
		B	100	68	66	66	59	67	75	83
		T	47	49	54	48	51	49	53	50
1	15 ÷ 30	Ø	Ø 1: 5	Ø 1: 3.5 Ø 2: 4.5	Ø 1.2: 3.5 Ø 3: 4.5	Ø 1.3: 3 Ø 4: 4	Ø 1.4: 3 Ø 5: 4	Ø 1.5: 3 Ø 6: 4	Ø 1.6: 3 Ø 7: 3.5	Ø 1.8: 2.5
		S	2500	976	685	510	412	344	311	296
		V	1500	1500	1500	1500	1500	1500	1500	2000
		F	7.2	9.6	12.7	12.6	14.8	16.8	18.2	20.4
		B	100	66	64	58	58	58	75	87
		T	56	56	51	56	53	50	55	56
2	30 ÷ 60	Ø	Ø 1: 10	Ø 1: 4.5 Ø 2: 7	Ø 1.2: 4 Ø 3: 5.5	Ø 1.2: 4 Ø 3: 4.5 Ø 4: 5				
		S	1250	428	325	270				
		V	2000	2250	2500	2750				
		F	31.5	39.4	46.4	60.2				
		B	100	59	61	81				
		T	51	53	56	53				
2	15 ÷ 30	Ø	Ø 1: 5	Ø 1: 3.5 Ø 2: 4.5	Ø 1.2: 3.5 Ø 3: 4.5	Ø 1.3: 3.5 Ø 4: 4				
		S	1250	488	343	278				
		V	1500	1500	1500	1500				
		F	14.2	18.6	24.1	27.7				
		B	100	66	65	80				
		T	57	58	54	58				
4	20 ÷ 40	Ø	Ø 1: 6	Ø 1: 3.5 Ø 2: 4						
		S	625	277						
		V	1750	2500						
		F	37.1	51.7						
		B	100	81						
		T	58	59						
4	5 ÷ 20	Ø	Ø 1: 4	Ø 1: 3 Ø 2: 3.5						
		S	625	266						
		V	1500	1500						
		F	20.2	26.1						
		B	100	76						
		T	45	47						

Table A2_CT

Detection class	A
Number of detectors	2
Anti-dust filter	No
Condensation trap	Yes

D1	detector 1 module
D2	detector 2 module
CT	trap for condensation
Øn	diameter of the hole "n" (mm)
S	detection sensitivity (10 ⁻⁵ dB/m)
V	aspiration speed (RPM)
F	expected airflow (l/min)
B	air aspiration balancing between the holes (%)
T	transit time of the smoke (s)

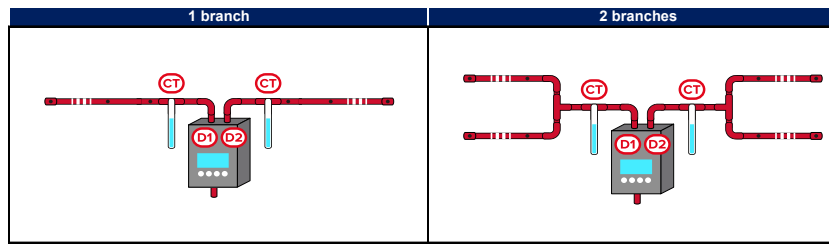

Number of branches	Length of branches (m)	parameters	Number of holes for each branch							
			1	2	3	4	5	6	7	8
1	30 ÷ 60	Ø	Ø 1: 10	Ø 1: 5 Ø 2: 8	Ø 1,2: 4 Ø 3: 5.5	Ø 1: 3.5 Ø 2,3: 4 Ø 4: 5.5	Ø 1,2: 3 Ø 3,4: 3.5 Ø 5: 4.5	Ø 1,2: 3 Ø 3,5: 3.5 Ø 6: 4.5	Ø 1: 3 Ø 2,5: 3.5 Ø 6: 4 Ø 7: 4.5	Ø 1: 3 Ø 2,4: 3.5 Ø 5,6: 4 Ø 7,8: 4.5
		S	2500	876	650	490	384	334	298	268
		V	2000	2250	2500	2500	2750	2750	3000	3250
		F	31.6	43.3	46.7	51.8	54.4	60.4	71.1	81.2
		B	100	64	61	60	56	60	69	80
		T	51	49	55	55	56	56	54	53
1	10 ÷ 30	Ø	Ø 1: 5	Ø 1: 3.5 Ø 2: 4.5	Ø 1,2: 3.5 Ø 3: 4.5	Ø 1,3: 3 Ø 4: 4	Ø 1,4: 3 Ø 5: 4	Ø 1,4: 2.5 Ø 5: 3 Ø 6: 3.5	Ø 1,6: 2.5 Ø 7: 3	Ø 1,8: 2.5
		S	2500	964	684	512	414	334	322	298
		V	1500	1500	1500	1500	1500	1750	2000	2250
		F	14.6	18.9	24.7	24.3	28.1	30.7	36.1	43.5
		B	100	65	64	58	58	53	70	89
		T	49	50	46	51	49	45	46	47
2	20 ÷ 40	Ø	Ø 1: 6	Ø 1: 3.5 Ø 2: 4.5	Ø 1,2: 3 Ø 3: 4	Ø 1,4: 2.5				
		S	1250	488	332	306				
		V	1750	2250	2500	3750				
		F	37.3	50.4	59.2	74.8				
		B	100	66	59	96				
		T	58	57	56	61				
2	5 ÷ 20	Ø	Ø 1: 4	Ø 1: 2.5 Ø 2: 3.5	Ø 1,2: 2.5 Ø 3: 3	Ø 1,4: 2.5				
		S	1250	426	364	308				
		V	1500	1500	1750	2000				
		F	20.2	23.3	31.2	40.6				
		B	100	53	70	97				
		T	44	49	46	47				

Table C1_CT, holes from 37 to 46

Detection class	C
Number of detectors	1
Anti-dust filter	No
Condensation trap	Yes

D1	detector 1 module
CT	trap for condensation

Øn	diameter of the hole "n" (mm)
S	detection sensitivity (10 ⁻⁵ dB/m)
V	aspiration speed (RPM)
F	expected airflow (l/min)
B	air aspiration balancing between the holes (%)
T	transit time of the smoke (s)

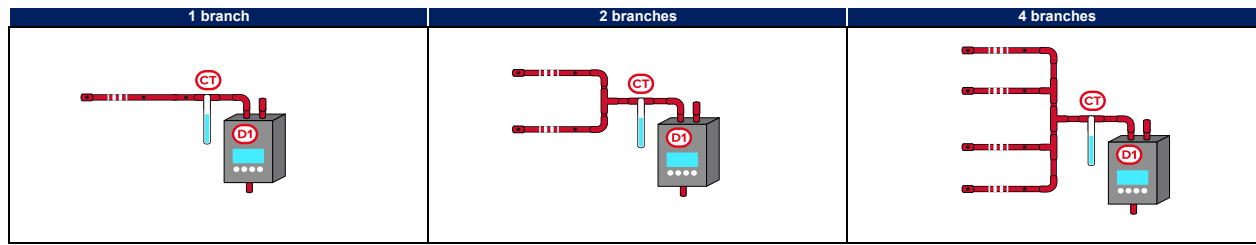

Number of branches	Length of branches (m)	parameters	Number of holes for each branch										
			37	38	39	40	41	42	43	44	45	46	
1	60 ÷ 90	Ø											
		S											
		V											
		F											
		B											
		T											
1	30 ÷ 60	Ø											
		S											
		V											
		F											
		B											
		T											
1	15 ÷ 30	Ø	Ø 1..37: 2	Ø 1..38: 2	Ø 1..39: 2	Ø 1..40: 2					Ø 1..20: 2 Ø 21..45: 2.5	Ø 1..18: 2 Ø 19..29: 2.5 Ø 30..46: 3	
		S	422	413	409	391					348	332	
		V	2000	2250	3000	2750					4750	4750	
		F	41.0	46.5	62.9	58.0					110.9	125.6	
		B	53	53	53	51					54	61	
		T	51	46	33	37					20	15	

Table C2_CT, holes from 19 to 36

Detection class	C
Number of detectors	2
Anti-dust filter	No
Condensation trap	Yes

D1	detector 1 module
D2	detector 2 module
CT	trap for condensation
$\emptyset n$	diameter of the hole "n" (mm)
S	detection sensitivity (10^{-5} dB/m)
V	aspiration speed (RPM)
F	expected airflow (l/min)
B	air aspiration balancing between the holes (%)
T	transit time of the smoke (s)

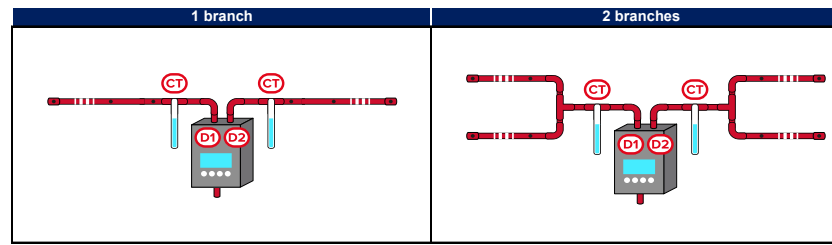

Number of branches	Length of branches (m)	parameters	Number of holes for each branch							
			19	20	21	22	23	24	25	26
1	30 ÷ 60	\emptyset	\emptyset 1..12: 2 \emptyset 13..18: 2.5 \emptyset 19: 3	\emptyset 1..13: 2 \emptyset 14..19: 2.5 \emptyset 20: 3	\emptyset 1..14: 2 \emptyset 15..20: 2.5 \emptyset 21: 3	\emptyset 1..21: 2 \emptyset 22: 2.5	\emptyset 1..22: 2 \emptyset 23: 2.5	\emptyset 1..23: 2 \emptyset 24: 2.5	\emptyset 1..24: 2 \emptyset 25: 2.5	\emptyset 1..25: 2 \emptyset 26: 2.5
		S	782	740	696	750	710	670	638	608
		V	3750	3750	3750	4250	4250	4250	4500	4500
		F	91.8	93.4	94.6	104.9	106.9	108.3	116.6	118.2
		B	50	50	50	62	60	58	57	55
		T	53	55	55	56	56	57	54	54
1	10 ÷ 30	\emptyset	\emptyset 1..19: 2	\emptyset 1..20: 2						
		S	994	942						
		V	3500	4250						
		F	88.8	110.7						
		B	84	83						
		T	30	25						

Table A1_DF_CT

Detection class	A
Number of detectors	1
Anti-dust filter	Yes
Condensation trap	Yes

D1	detector 1 module
DF	filter for dust
CT	trap for condensation
Øn	diameter of the hole "n" (mm)
S	detection sensitivity (10 ⁻⁵ dB/m)
V	aspiration speed (RPM)
F	expected airflow (l/min)
B	air aspiration balancing between the holes (%)
T	transit time of the smoke (s)

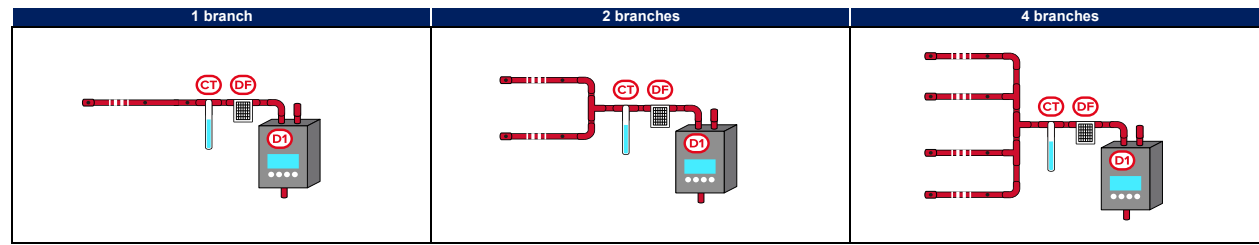

Number of branches	Length of branches (m)	parameters	Number of holes for each branch							
			1	2	3	4	5	6	7	8
1	60 ÷ 90	Ø	Ø 1: 10	Ø 1: 4.5 Ø 2: 7.5	Ø 1: 4 Ø 2: 4.5 Ø 3: 7	Ø 1.2: 4 Ø 3: 4.5 Ø 4: 7	Ø 1.2: 3.5 Ø 3: 4 Ø 4: 4.5 Ø 5: 6	Ø 1: 3 Ø 2: 3.5 Ø 3: 4 Ø 4.5: 4.5 Ø 6: 6.5	Ø 1: 3 Ø 2.3: 3.5 Ø 4.5: 4 Ø 6: 4.5 Ø 7: 5.5	
		S	2500	856	642	479	381	335	302	
		V	3000	3250	3750	3750	4250	4250	4750	
		F	22.8	28.7	34	38.1	43.6	49.2	53.4	
		B	100	58	57	56	58	57	69	
		T	59	60	60	62	61	58	61	
1	30 ÷ 60	Ø	Ø 1: 10	Ø 1: 4.5 Ø 2: 6.5	Ø 1: 4 Ø 2: 4.5 Ø 3: 6.5	Ø 1: 4 Ø 2: 4.5 Ø 3: 5.5 Ø 4: 8	Ø 1.2: 3 Ø 3.4: 3.5 Ø 5: 4.5	Ø 1: 3 Ø 2.4: 3.5 Ø 5: 4 Ø 6: 5	Ø 1.3: 3 Ø 4.6: 3.5 Ø 7: 4	Ø 1.2: 3 Ø 3.5: 3.5 Ø 6.8: 4
		S	2500	915	623	491	382	332	295	264
		V	2000	2250	2250	2250	2750	2500	3000	3250
		F	16.4	19.8	23.3	28.4	28.5	30.4	35.5	43.3
		B	100	64	61	64	55	58	71	82
		T	49	54	53	50	53	54	54	50
1	15 ÷ 30	Ø	Ø 1: 5	Ø 1: 3.5 Ø 2: 4.5	Ø 1.2: 3.5 Ø 3: 4.5	Ø 1.3: 3 Ø 4: 4	Ø 1.4: 3 Ø 5: 4	Ø 1.5: 3 Ø 6: 4	Ø 1.3: 3 Ø 4.6: 3.5 Ø 7: 4	Ø 1.8: 2.5
		S	2500	976	685	510	411	342	295	295
		V	1500	1500	1500	1500	1500	1500	1500	2000
		F	7.2	9.4	12.4	12.2	14.2	16	18.9	19.6
		B	100	66	65	58	58	58	70	87
		T	56	57	52	58	55	53	50	59
2	30 ÷ 60	Ø	Ø 1: 7.5	Ø 1: 4.5 Ø 2: 6.5	Ø 1: 4 Ø 2: 4.5 Ø 3: 6	Ø 1: 4 Ø 2: 4.5 Ø 3: 5 Ø 4: 5.5				
		S	1250	460	327	271				
		V	2250	2500	2750	3000				
		F	29.1	38.8	47.9	58.7				
		B	100	65	66	89				
		T	56	55	53	55				
2	15 ÷ 30	Ø	Ø 1: 5	Ø 1: 3.5 Ø 2: 5	Ø 1.2: 3.5 Ø 3: 4.5	Ø 1: 4 Ø 2: 4.5 Ø 3: 5 Ø 4: 5.5				
		S	1250	433	343	270				
		V	1500	1500	1500	1500				
		F	13.7	19	22	29.7				
		B	100	55	65	89				
		T	59	54	59	54				
4	20 ÷ 40	Ø	Ø 1: 6	Ø 1: 4.5 Ø 2: 5.5						
		S	625	269						
		V	2000	2500						
		F	37	55.5						
		B	100	80						
		T	58	54						
4	5 ÷ 20	Ø	Ø 1: 4	Ø 1: 3.5 Ø 2: 4						
		S	625	274						
		V	1500	1500						
		F	19	27.9						
		B	100	80						
		T	47	45						

Table A2_DF_CT

Detection class	A
Number of detectors	2
Anti-dust filter	Yes
Condensation trap	Yes

D1	detector 1 module
D2	detector 2 module
DF	filter for dust
CT	trap for condensation
Øn	diameter of the hole "n" (mm)
S	detection sensitivity (10 ⁻⁵ dB/m)
V	aspiration speed (RPM)
F	expected airflow (l/min)
B	air aspiration balancing between the holes (%)
T	transit time of the smoke (s)

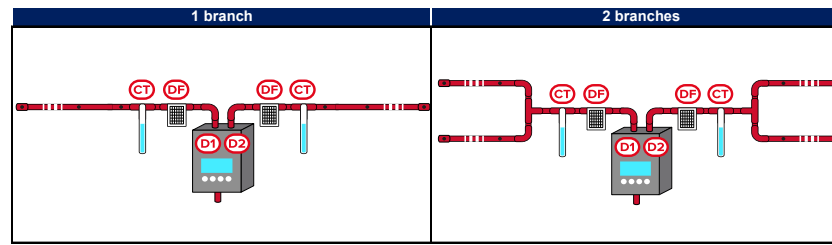

Number of branches	Length of branches (m)	parameters	Number of holes for each branch							
			1	2	3	4	5	6	7	8
1	30 ÷ 60	Ø	Ø 1: 10	Ø 1: 4.5 Ø 2: 7	Ø 1: 4 Ø 2: 4.5 Ø 3: 6	Ø 1..3: 3.5 Ø 4: 5	Ø 1..3: 3.5 Ø 4: 4 Ø 5: 5	Ø 1: 3 Ø 2..4: 3.5 Ø 5: 4 Ø 6: 5	Ø 1..2: 3 Ø 3..6: 3.5 Ø 7: 4	Ø 1..2: 3 Ø 3..5: 3.5 Ø 6..8: 4
		S	2500	860	654	478	398	332	300	266
		V	2000	2250	2500	2750	2750	2750	3250	3500
		F	30.6	38.3	47.6	51.5	58.1	60.7	71.1	80.9
		B	100	60	66	53	59	58	78	80
1	10 ÷ 30	T	53	55	54	54	54	55	56	54
		Ø	Ø 1: 5	Ø 1: 3.5 Ø 2: 4.5	Ø 1..2: 3.5 Ø 3: 4.5	Ø 1..3: 3.5 Ø 4: 4.5	Ø 1..4: 3 Ø 5: 4	Ø 1..5: 3 Ø 6: 4	Ø 1..6: 2.5 Ø 7: 3	Ø 1..8: 2.5
		S	2500	964	684	518	412	344	322	298
		V	1500	1500	1500	1500	1500	1500	2000	2250
		F	14.4	18.6	24	28.5	27.2	30.1	35.1	42.1
2	20 ÷ 40	B	100	66	64	64	58	58	70	89
		T	50	51	48	46	51	50	47	48
		Ø	Ø 1: 5.5	Ø 1: 3.5 Ø 2: 4.5	Ø 1..2: 3 Ø 3: 4	Ø 1..4: 3				
		S	1250	490	332	302				
		V	2000	2250	2500	3250				
2	5 ÷ 20	F	38.3	48.1	56.3	78				
		B	100	66	59	92				
		T	56	60	59	59				
		Ø	Ø 1: 4	Ø 1: 2.5 Ø 2: 3.5	Ø 1..2: 2.5 Ø 3: 3	Ø 1..4: 2.5				
		S	1250	426	364	308				
2	5 ÷ 20	V	1500	1500	1750	2000				
		F	19.9	22.8	30.4	39.2				
		B	100	53	70	97				
		T	45	50	48	48				

Table C1_DF_CT, holes from 1 to 18

Detection class	C
Number of detectors	1
Anti-dust filter	Yes
Condensation trap	Yes

D1	detector 1 module
DF	filter for dust
CT	trap for condensation
Øn	diameter of the hole "n" (mm)
S	detection sensitivity (10 ⁻⁵ dB/m)
V	aspiration speed (RPM)
F	expected airflow (l/min)
B	air aspiration balancing between the holes (%)
T	transit time of the smoke (s)

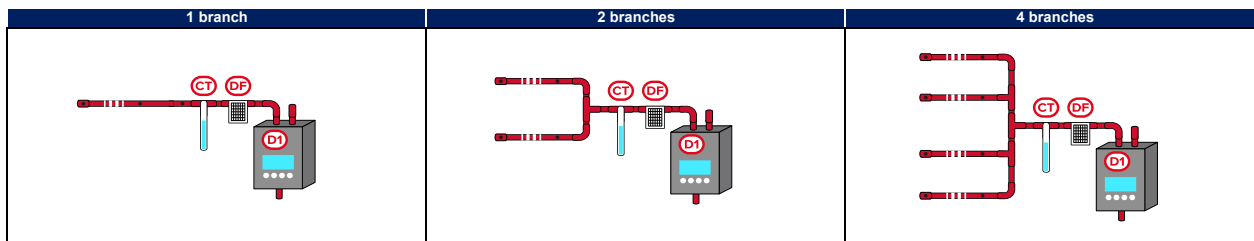

Number of branches	Length of branches (m)	parameters	Number of holes for each branch																			
			1	2	3	4	5	6	7	8	9	10	11	12	13	14	15	16	17	18		
1	60 ÷ 90	Ø	Ø 1: 10	Ø 1: 4.5 Ø 2: 7.5	Ø 1: 4 Ø 2: 4.5 Ø 3: 7.5	Ø 1: 3.5 Ø 2: 4 Ø 3: 4.5 Ø 4: 7	Ø 1.2: 3.5 Ø 3: 4 Ø 4: 4.5 Ø 5: 7	Ø 1: 2.5 Ø 2: 4: 3 Ø 5: 3.5 Ø 6: 4.5	Ø 1: 2.5 Ø 2: 3: 3 Ø 4: 6: 3.5 Ø 7: 5	Ø 1: 2.5 Ø 2: 4: 3 Ø 5: 7: 3.5 Ø 8: 5	Ø 1: 2.5 Ø 2: 3: 3 Ø 4: 5: 3.5 Ø 7: 4.5 Ø 8: 5 Ø 9: 7.5	Ø 1.3: 2.5 Ø 4: 8: 3 Ø 6: 4 Ø 9: 3.5 Ø 10: 4.5 Ø 11: 5.5	Ø 1.3: 2.5 Ø 4: 6: 3 Ø 7: 8: 3.5 Ø 9: 10: 4 Ø 11: 5.5				Ø 1.2: 2 Ø 3..7: 2.5 Ø 8..11: 3 Ø 12..13: 3.5 Ø 14: 4.5					
		S	20000	6848	4929	3937	2983	2463	2166	2018	1758	1541	1468	1089	4750							
		V	3000	3250	3500	3750	3750	4250	4500	4250	4500	4500	4750									
		F	22.8	28.7	32.9	37.1	40.6	39.2	45.8	45.2	51.8	49.4	55.3	55.2								
		T	59	60	62	60	62	67	62	67	62	68	61	66								
1	30 ÷ 60	Ø	Ø 1: 10	Ø 1: 4 Ø 2: 6.5	Ø 1: 4 Ø 2: 4.5 Ø 3: 5 Ø 6: 5	Ø 1: 4 Ø 2: 4.5 Ø 3: 5 Ø 4: 8	Ø 1: 3 Ø 2: 4: 3.5 Ø 5: 5	Ø 1.2: 3 Ø 3: 5: 3.5 Ø 6: 5	Ø 1.3: 3 Ø 4: 6: 3.5 Ø 7: 5	Ø 1.3: 2.5 Ø 4: 7: 3 Ø 8: 4	Ø 1.3: 2.5 Ø 3: 7: 3 Ø 8: 4 Ø 9: 3.5 Ø 10: 4.5	Ø 1.2: 2.5 Ø 3: 6: 3 Ø 7: 9: 3.5 Ø 10: 4.5	Ø 1.5: 2.5 Ø 6: 10: 3 Ø 11: 4	Ø 1.6: 2.5 Ø 7: 11: 3 Ø 12: 4	Ø 1.7: 2.5 Ø 8: 12: 3 Ø 13: 4	Ø 1.8: 2 Ø 9: 13: 2.5 Ø 14: 3	Ø 1.9: 2 Ø 10: 14: 2.5 Ø 15: 3	Ø 1.9: 2 Ø 10: 15: 2.5 Ø 16: 3	Ø 1.10: 2 Ø 11: 16: 2.5 Ø 17: 3	Ø 1.11: 2 Ø 12: 17: 2.5 Ø 18: 3		
		S	20000	6246	4983	3932	3000	2500	2215	1892	1716	1557	1407	1293	1186	1085	1019	948	894	842		
		V	2000	2250	2250	2250	2500	2500	2750	2750	2750	2750	3000	3000	3000	3000	3250	3250	3250	3250		
		F	16.4	18.8	23.3	28.1	27.1	29.1	31.0	31.3	32.4	35.5	37.8	39.4	39.6	37.5	38.3	40.3	40.5	41.5		
		T	49	54	53	50	55	54	54	56	58	55	53	53	55	56	56	56	56	57		
1	15 ÷ 30	Ø	Ø 1: 5	Ø 1: 3 Ø 2: 4.5	Ø 1.2: 3 Ø 3: 4.5	Ø 1.3: 3 Ø 4: 4	Ø 1.4: 3 Ø 5: 4	Ø 1: 2.5 Ø 2: 5: 3 Ø 6: 4	Ø 1: 2.5 Ø 2: 6: 3 Ø 7: 4	Ø 1.2: 2.5 Ø 3: 7: 3 Ø 8: 4	Ø 1.8: 2.5 Ø 9: 3: 5	Ø 1.9: 2.5 Ø 10: 3: 5	Ø 1.10: 2.5 Ø 11: 3: 5	Ø 1.11: 2.5 Ø 12: 3: 5	Ø 1.12: 2.5 Ø 13: 3: 5	Ø 1.10: 2.5 Ø 11: 13: 3 Ø 14: 3: 5	Ø 1: 2 Ø 2: 11: 2.5 Ø 12: 14: 3 Ø 15: 3: 5	Ø 1.2: 2 Ø 3: 12: 2.5 Ø 13: 15: 3 Ø 16: 3: 5	Ø 1.3: 2 Ø 4: 13: 2.5 Ø 14: 16: 3 Ø 17: 3: 5	Ø 1.3: 2 Ø 4: 14: 2.5 Ø 15: 17: 3 Ø 18: 3: 5		
		S	20000	6398	4743	4081	3291	2387	2108	1883	1830	1638	1477	1341	1223	1102	952	903	857	825		
		V	1500	1500	1500	1500	1500	1500	1500	1500	1500	1500	1500	1500	1500	1500	1500	1500	1500	1500		
		F	7.2	8.6	10.9	12.2	14.2	15.4	17.0	18.0	16.5	17.6	18.7	19.6	20.5	22.0	22.2	22.5	22.8	23.4		
		T	56	59	54	58	55	52	51	50	57	56	56	55	55	52	52	52	52	52		
2	30 ÷ 60	Ø	Ø 1: 7.5	Ø 1: 4 Ø 2: 6.5	Ø 1: 4 Ø 2: 4.5 Ø 3: 7	Ø 1: 3.5 Ø 2: 3: 4 Ø 4: 6	Ø 1.4: 3 Ø 5: 4.5	Ø 1.2: 3 Ø 3: 5: 3.5 Ø 6: 5	Ø 1.3: 2.5 Ø 4: 7: 3 Ø 8: 4	Ø 1.3: 2.5 Ø 4: 8: 3 Ø 9: 4	Ø 1.2: 2.5 Ø 3: 6: 3 Ø 7: 9: 3.5 Ø 10: 4.5	Ø 1.3: 2.5 Ø 4: 8: 3 Ø 9: 4	Ø 1.4: 2.5 Ø 5: 9: 3 Ø 10: 4	Ø 1.5: 2.5 Ø 6: 10: 3 Ø 11: 4	Ø 1.6: 2.5 Ø 7: 11: 3 Ø 12: 3	Ø 1.7: 2.5 Ø 8: 12: 3 Ø 13: 4	Ø 1.8: 2 Ø 9: 13: 2.5 Ø 14: 3	Ø 1.9: 2 Ø 10: 14: 2.5 Ø 15: 3	Ø 1.9: 2 Ø 10: 15: 2.5 Ø 16: 3	Ø 1.9: 2 Ø 11: 16: 2.5 Ø 17: 3	Ø 1.11: 2 Ø 12: 17: 2.5 Ø 18: 3	
		S	10000	3137	2432	1902	1509	1283	1123	948	865	743	712	649	596	541	505	478	444	415		
		V	2250	2500	2500	2750	3000	3000	3000	3250	3500	3500	3500	3750	3750	4000	4000	4000	4000	4250		
		F	29.1	37.3	44.0	50.2	49.9	57.0	60.8	60.8	67.5	71.0	71.7	66.6	78.3	75.5	77.1	78.8	79.7	86.0		
		T	56	54	55	54	59	56	55	58	55	56	56	56	59	56	56	56	57	58		
2	15 ÷ 30	Ø	Ø 1: 5	Ø 1: 3.5 Ø 2: 5	Ø 1.2: 3 Ø 3: 4.5	Ø 1.3: 3 Ø 4: 4.5	Ø 1.4: 3 Ø 5: 4.5	Ø 1.2: 3 Ø 3: 5: 3.5 Ø 6: 5	Ø 1.6: 2.5 Ø 7: 3: 5	Ø 1.7: 2.5 Ø 8: 3: 5	Ø 1.8: 2.5 Ø 9: 3: 5	Ø 1.4: 2.5 Ø 5: 9: 3 Ø 10: 4	Ø 1.5: 2.5 Ø 6: 10: 3 Ø 11: 4	Ø 1.6: 2.5 Ø 7: 11: 3 Ø 12: 4	Ø 1.7: 2.5 Ø 8: 12: 2.5 Ø 13: 3	Ø 1.7: 2 Ø 9: 13: 2.5 Ø 14: 3	Ø 1.8: 2 Ø 10: 14: 2.5 Ø 15: 3	Ø 1.8: 2 Ø 10: 15: 2.5 Ø 16: 3	Ø 1.9: 2 Ø 11: 16: 2.5 Ø 17: 3	Ø 1.10: 2 Ø 12: 17: 2.5 Ø 18: 3		
		S	9999	3465	2374	1861	1510	1281	1181	1032	913	777	710	652	587	543	511	480	451	425		
		V	1500	1500	1500	1500	1500	1500	1750	1750	1750	1750	1750	1750	2000	2000	2000	2000	2000	2000		
		F	13.7	19.0	19.8	22.8	25.2	28.9	28.6	30.5	32.2	35.8	36.6	37.3	38.5	39.8	40.6	41.3	42.0	42.6		
		T	59	54	59	58	58	55	59	59	59	59	54	55	56	53	53	53	54	54		
4	20 ÷ 40	Ø	Ø 1: 6	Ø 1: 4 Ø 2: 6.5	Ø 1.2: 3 Ø 3: 4.5	Ø 1.2: 3 Ø 3: 3.5 Ø 4: 4.5	Ø 1.4: 3 Ø 5: 4	Ø 1: 2.5 Ø 2: 5: 3 Ø 6: 4	Ø 1.5: 2 Ø 7: 3 Ø 8: 3	Ø 1.6: 2 Ø 7: 2.5 Ø 8: 3	Ø 1.7: 2 Ø 8: 2.5 Ø 9: 3	Ø 1.6: 2 Ø 7: 9: 2.5 Ø 10: 3	Ø 1.10: 2 Ø 11: 2.5	Ø 1.11: 2 Ø 12: 2.5								
		S	5000	1575	1187	926	819	608	557	496	432	383	410	376								
		V	2000	2250	2500	2750	3000	3000	3250	3500	3500	3500	4000	4250								
		F	37.0	50.2	51.5	62.6	69.8	71.6	67.1	75.6	79.1	82.2	92.2	100.4								
		T	58	54	61	57	60	61	62	57	59	59	62	58								
4	5 ÷ 20	Ø	Ø 1: 4	Ø 1: 3 Ø 2: 4	Ø 1.2: 2.5 Ø 3: 3.5	Ø 1.3: 2.5 Ø 4: 3.5	Ø 1.4: 2.5 Ø 5: 3	Ø 1.5: 2 Ø 6: 2.5	Ø 1.6: 2 Ø 7: 2.5	Ø 1.7: 2 Ø 8: 2.5	Ø 1.8: 2 Ø 9: 2.5	Ø 1.9: 2 Ø 10: 2.5	Ø 1.11: 2	Ø 1.12: 2								
		S	5000	1820	1264	997	900	751	649	570	507	458	440	401								
		V	1500	1500	1500	1500	1750	2000	2000	2000	2000	2250	2500	2500								
		F	19.0	26.0	26.1	29.6	36.3	36.6	39.5	41.9	43.9	51.2	57.8	59.4								
		T	47	45	51	50	50	51	50	50	50	44	48	48								

Table C1_DF_CT, holes from 37 to 41

Detection class	C
Number of detectors	1
Anti-dust filter	Yes
Condensation trap	Yes

D1	detector 1 module
DF	filter for dust
CT	trap for condensation
$\emptyset n$	diameter of the hole "n" (mm)
S	detection sensitivity (10^{-5} dB/m)
V	aspiration speed (RPM)
F	expected airflow (l/min)
B	air aspiration balancing between the holes (%)
T	transit time of the smoke (s)

Number of branches	Length of branches (m)	parameters	Number of holes for each branch				
			37	38	39	40	41
1	60 ÷ 90	\emptyset					
		S					
		V					
		F					
		B					
		T					
1	30 ÷ 60	\emptyset					
		S					
		V					
		F					
		B					
		T					
1	15 ÷ 30	\emptyset	\emptyset 1.37: 2	\emptyset 1.38: 2	\emptyset 1.39: 2	\emptyset 1.40: 2	\emptyset 1.40: 2 \emptyset 41: 2.5
		S	429	416	405	401	390
		V	2500	2750	3000	4500	4000
		F	46.0	49.8	54.9	83.8	78.7
		B	56	53	53	54	57
		T	45	42	39	25	23

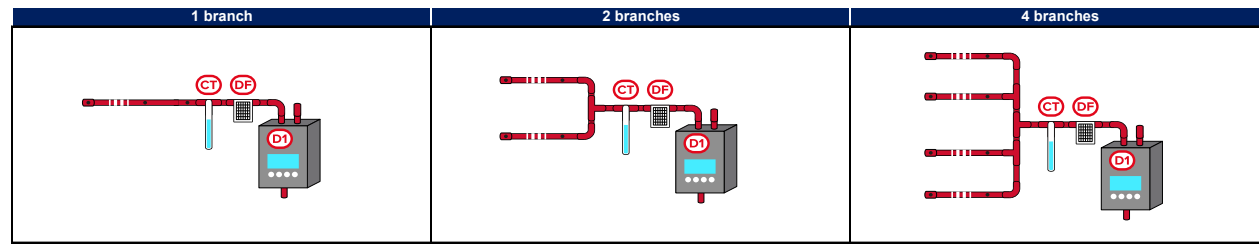
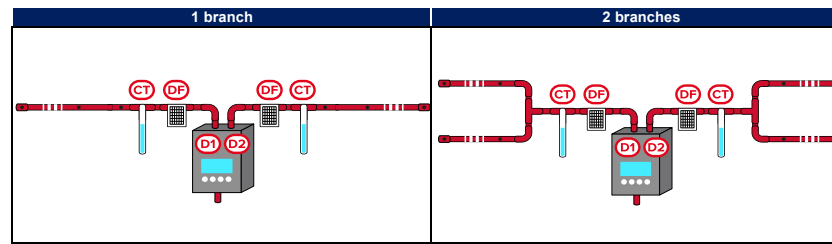

Table C2_DF_CT, holes from 19 to 27

Detection class	C
Number of detectors	2
Anti-dust filter	Yes
Condensation trap	Yes

D1	detector 1 module
D2	detector 2 module
DF	filter for dust
CT	trap for condensation
Øn	diameter of the hole "n" (mm)
S	detection sensitivity (10 ⁻⁶ dB/m)
V	aspiration speed (RPM)
F	expected airflow (l/min)
B	air aspiration balancing between the holes (%)
T	transit time of the smoke (s)



Number of branches	Length of branches (m)	parameters	Number of holes for each branch									
			19	20	21	22	23	24	25	26	27	
1	30 ÷ 60	Ø	Ø 1..12: 2 Ø 13..18: 2.5 Ø 19: 3	Ø 1..10: 2 Ø 11..19: 2.5 Ø 20: 3	Ø 1..14: 2 Ø 15..20: 2.5 Ø 21: 3	Ø 1..11: 2 Ø 12..21: 2.5 Ø 22: 3	Ø 1..22: 2 Ø 23: 2.5	Ø 1..17: 2 Ø 18..23: 2.5 Ø 24: 3	Ø 1..13: 2 Ø 14..24: 2.5 Ø 25: 3	Ø 1..25: 2 Ø 26: 2.5	Ø 1..26: 2 Ø 27: 2.5	
		S	780	734	696	662	712	594	566	608	576	
		V	3750	4000	4000	4000	4250	4250	4250	4750	4750	
		F	89.5	97.7	95.9	97.1	104.5	105.5	106.6	117.9	119.1	
		B	50	50	50	50	63	50	50	55	53	
		T	55	52	54	56	57	53	55	54	55	
1	10 ÷ 30	Ø	Ø 1..19: 2	Ø 1..20: 2	Ø 1..21: 2	Ø 1..22: 2	Ø 1..23: 2					
		S	982	932	884	844	804					
		V	2750	3000	3250	3750	4250					
		F	66.7	74.1	81.7	96.1	110.9					
		B	83	82	80	79	78					
		T	41	37	34	29	26					

Notes

Disposal of the product



Informative notice regarding the disposal of electrical and electronic equipment (applicable in countries with differentiated waste collection systems)

■ The crossed-out bin symbol on the equipment or on its packaging indicates that the product must be disposed of correctly at the end of its working life and should never be disposed of together with general household waste. The user, therefore, must take the equipment that has reached the end of its working life to the appropriate civic amenities site designated to the differentiated collection of electrical and electronic waste. As an alternative to the autonomous-management of electrical and electronic waste, you can hand over the equipment you wish to dispose of to a dealer when purchasing new equipment of the same type. You are also entitled to convey for disposal small electronic-waste products with dimensions of less than 25cm to the premises of electronic retail outlets with sales areas of at least 400m², free of charge and without any obligation to buy. Appropriate differentiated waste collection for the subsequent recycling of the discarded equipment, its treatment and its environmentally compatible disposal helps to avoid possible negative effects on the environment and on health and favours the re-use and/or recycling of the materials it is made of.



Information about disposal of batteries and accumulators (applicable in Countries with separate collection systems)

This marking on batteries and/or their manual and/or their packaging, indicates that batteries of this products, at the end of their working life, should not be disposed of as unsorted municipal waste, but must be object of a separate collection. Where marked, the chemical symbols Hg, Cd o Pb indicate that the battery contains mercury, cadmium or lead above the reference levels of the directive 2006/66/EC. If batteries are not properly disposed of, these substances, together with other ones contained, can cause harm to human health and to the environment. To protect human health and the environment, to facilitate treatment and recycling of materials, separate batteries from other kind of waste and use the collection scheme stated in your area, in accordance to current laws. Before disposing of the above, it's appropriate to remove them from their holders avoiding to damage them or causing short circuits.



Inim Electronics S.r.l.

ISO 9001 Quality Management
certified by BSI with certificate number FM530352

Via dei Lavoratori 10, Località Centobuchi
63076 Montepandone (AP) - ITALY
Tel. +39 0735 705007 - Fax +39 0735 704912

info@inim.it - www.inim.it



DCMIINE0FA100-110-20240508