

DH-XVR5108/16HE-X

8/16 Channel Penta-brid 1080P Mini 1U Digital Video Recorder

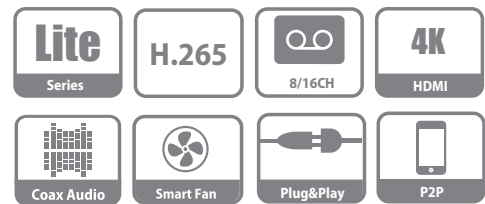

- H.265+/H.265 dual-stream video compression
- Supports HDCVI/AHD/TVI/CVBS/IP video inputs
- Max 12/24 channels IP camera inputs, each channel up to 6MP; Max 48/96Mbps Incoming Bandwidth
- Smart Search and Intelligent Video System



System Overview

With the surveillance operators pursuing to HD/UHD which further adds the storage and transmission cost, HDCVI H.265+/H.265 has been released to incredibly decrease the required bitrate while ensuring the video quality in realizing high resolution surveillance such as 4MP/4K.

The Lite Series is designed for high cost performance and quality. The range offers a great solution for users facing budget constraints who both require quality and performance. And with the adoption of Smart H.265+/H.265, the series improves encoding efficiency, saving on bandwidth/storage costs, and significantly reducing the Total Cost of Ownership (TCO).

Functions

Smart H.265+

Smart Codec, H.265+ can reduce up to 90% bit rate and storage requirements compared with H.264 without having to invest in new cameras.

HDCVI/AHD/TVI/CVBS Auto-detect

The XVR can auto recognize the signal of front-camera without any setting. It makes operation more friendly and convenient.

High Definition Camera Input

The XVR supports up to 5MP HDCVI camera and 6MP IP camera input.

Coaxial Audio/Upgrade/Alarm

The integrated design can reduce wiring troubles which makes it much more cost-effective and convenient for installation.

Long Distance Transmission

The HDCVI system supports long distance transmission over coaxial cable and UTP, max. 700m for 4K/4MP, 800m for 1080P and 1200m for 720P.

Smart Fan Design

The smart fan can automatically turn on or turn off according to the CPU temperature. This function can effectively reduce the fan noise to provide a better user experience.

Intelligent Video System (IVS)

With built-in intelligent video analytics, the XVR has the ability to detect and analyze moving objects for improved video surveillance. The XVR provides optional standard intelligence at the edge allowing detection of multiple object behaviors such as abandoned or missing objects. IVS also supports Tripwire analytics, allowing the camera to detect when a pre-determined line has been crossed.

Face Detection

It is a typical technology being used in a variety of applications for searching or identification of individuals.

Smart Search

This function helps you get more motion detect video during a short time through drawing a region when playback. It is very useful when an emergency occurs.

Technical Specification

System

Main Processor	Embedded Processor
Operating System	Embedded LINUX

Video and Audio

Analog Camera Input	8/16 Channel, BNC
HDCVI Camera	5MP, 4MP, 1080P@25/30fps, 720P@50/60fps, 720P@25/30fps
AHD Camera	5MP, 4MP, 1080P@25/30, 720P@25/30fps
TVI Camera	5MP, 4MP, 1080P@25/30, 720P@25/30fps
CVBS Camera	PAL/NTSC
IP Camera Input	8+4/16+8 Channel, each channel up to 6MP
Audio In/Out	8/16 Channel input, 1 Channel output, RCA
Two-way Talk	Reuse audio in/out, RCA

Recording

Compression	H.265+/H.265/H.264+/H.264
Resolution	5M-N, 4M-N, 1080P, 1080N, 720P, 960H, D1, CIF
Record Rate	Main stream: 5M-N(1~10fps), 4M-N/1080P(1~15fps), 1080N/720P/960H/D1/CIF (1~25/30fps) Sub stream: D1/CIF(1~15fps)
Bit Rate	32Kbps ~ 6144Kbps Per Channel
Record Mode	Manual, Schedule (General, Continuous), MD (Video detection: Motion Detection, Video Loss, Tampering), Alarm, Stop
Record Interval	1 ~ 60 min (default: 60 min), Pre-record: 1 ~ 30 sec, Post-record: 10 ~ 300 sec
Audio Compression	AAC(only for the 1st channel), G.711A, G.711U, PCM
Audio Sample Rate	8KHz, 16 bit Per Channel
Audio Bit Rate	64Kbps Per Channel

Display

Interface	1 HDMI, 1 VGA
Resolution	HDMI: 8CH: 1920×1080, 1280×1024, 1280×720 16CH: 3840×2160, 2560×1440, 1920×1080, 1280×1024, 1280×720 VGA: 1920×1080, 1280×1024, 1280×720
Multi-screen Display	When IP extension mode not enabled: 8CH: 1/4/8/9 16CH: 1/4/8/9/16 When IP extension mode enabled: 8CH: 1/4/8/9/16 16CH: 1/4/8/9/16/25
OSD	Camera title, Time, Video loss, Camera lock, Motion detection, Recording

Network

Interface	8CH: 1 RJ-45 Port (100M) 16CH: 1 RJ-45 Port (1000M)
Network Function	HTTP, HTTPS, TCP/IP, IPv4/IPv6, Wi-Fi, 3G/4G, UPnP, RTSP, UDP, SMTP, NTP, DHCP, DNS, IP Filter, PPPoE, DDNS, FTP, Alarm Server, P2P, IP Search (Supports Dahua IP camera, DVR, NVS, etc.)
Max. User Access	128 users
Smart Phone	iPhone, iPad, Android
Interoperability	ONVIF 16.12, CGI Conformant

Video Detection and Alarm

Trigger Events	Recording, PTZ, Tour, Video Push, Email, FTP, Snapshot, Buzzer and Screen Tips
Video Detection	Motion Detection, MD Zones: 396 (22 × 18), Video Loss, Tampering and Diagnosis
Alarm input	8/16
Relay Output	3

Playback and Backup

Playback	8CH: 1/4/9 16CH: 1/4/9/16
Search Mode	Time /Date, Alarm, MD and Exact Search (accurate to second)
Playback Function	Play, Pause, Stop, Rewind, Fast play, Slow Play, Next File, Previous File, Next Camera, Previous Camera, Full Screen, Repeat, Shuffle, Backup Selection, Digital Zoom
Backup Mode	USB Device/Network

Storage

Internal HDD	1 SATA Port, up to 10TB capacity
eSATA	N/A

Auxiliary Interface

USB	8CH: 2 USB 2.0 16CH: 1 USB 2.0, 1 USB 3.0
RS232	N/A
RS485	1 Port, for PTZ Control

Electrical

Power Supply	DC12V/2A
Power Consumption (without HDD)	8CH: <10W 16CH: <15W

Construction

Dimensions	Mini 1U, 325mm×255mm×55mm (12.8" x 10" x 2.2")
Device with PFH101 Rack Mount Tray	483mm×281mm×56mm (19.0"×11.1"×2.2")
Net Weight (without HDD)	8CH: 1.2kg (2.6 lb) 16CH: 1.3kg (2.9 lb)
Gross Weight	8CH: 1.9kg (4.2 lb) 16CH: 2.2kg (4.9 lb)
Installation	Desktop installation

Environmental

Operating Conditions	-10°C ~ +55°C (+14°F ~ +131°F), 10%~ 90% RH
Storage Conditions	-20°C ~ +70°C (-4°F ~ +158°F), 0~ 90% RH

Third-party Support

Third-party Support	Dahua, Arecont Vision, AXIS, Bosch, Brickcom, Canon, CP Plus, Dynacolor, Honeywell, Panasonic, Pelco, Samsung, Sanyo, Sony, Videotec, Vivotek, and more
---------------------	---

Certifications

Certifications	FCC: Part 15 Subpart B
	CE: CE-LVD: EN 60950-1/IEC 60950-1 CE-EMC: EN 61000-3-2, EN 61000-3-3, EN 55032, EN 50130, EN 55024
	UL: UL 60950-1

Ordering Information

Type	Part Number	Description
8/16 Channel XVR	DH-XVR5108HE-X	8 Channel Penta-brid 1080P Mini 1U Digital Video Recorder
	DH-XVR5116HE-X	16 Channel Penta-brid 1080P Mini 1U Digital Video Recorder
Accessory, optional	DH-PFH101	Rack Mount Tray

Dimensions (mm)

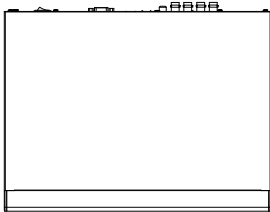
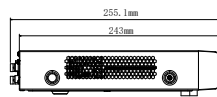
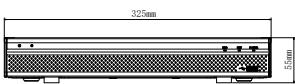

Installation on Rack Mount Tray

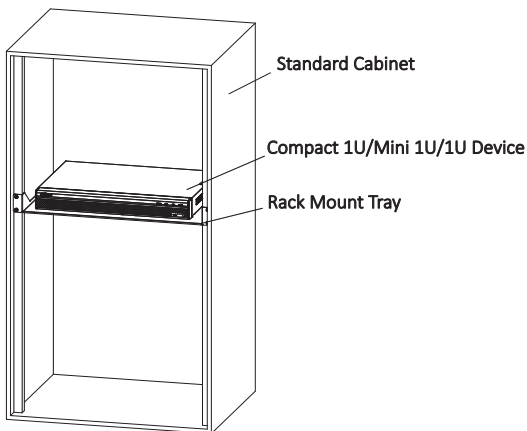

Rear Panel

DH-XVR5108HE-X

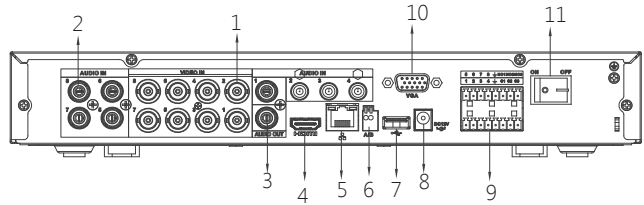

- 1 VIDEO IN
- 2 AUDIO IN, RCA Connector
- 3 AUDIO OUT, RCA Connector
- 4 HDMI Interface
- 5 Network Interface
- 6 RS485 Interface
- 7 USB Interface
- 8 DC12V Power Input
- 9 ALARM IN / OUT
- 10 VGA Interface
- 11 Power Switch

DH-XVR5116HE-X

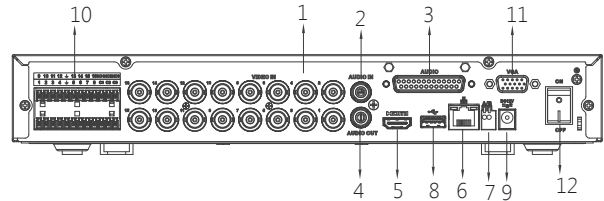

- 1 VIDEO IN
- 2 AUDIO IN, RCA Connector
- 3 AUDIO IN
- 4 AUDIO OUT
- 5 HDMI Interface
- 6 Network Interface
- 7 RS485 Interface
- 8 USB Interface
- 9 DC12V Power Input
- 10 ALARM IN / OUT
- 11 VGA Interface
- 12 Power Switch