

Transmitter Fibra user manual

Updated October 20, 2023

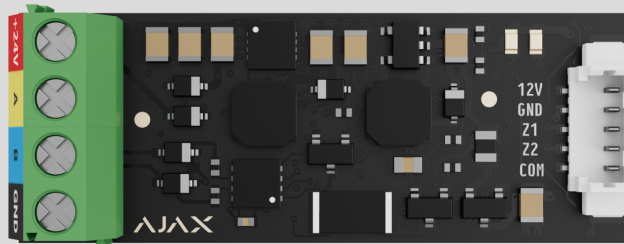

Transmitter Fibra is an integration module for connecting a third-party wired device into an Ajax system. It can be used to connect roller shutters, panic or auxiliary buttons, indoor or outdoor motion detectors, as well as opening, vibration, glass break, fire, gas, leak detectors, or other wired devices.

The integration module supports NC, NO, EOL, 2EOL, 3EOL, or Roller Shutter device connection types and can supply the connected device with 10.5–15 V_{DC}, up to 50 mA of power.

The module operates in the Ajax system and exchanges data with the hub using the secure Fibra wired communication protocol.



The integration module is compatible with [Hub Hybrid \(2G\)](#) and [Hub Hybrid \(4G\)](#). Connection to other [hubs](#), [radio signal range extenders](#), [ocBridge Plus](#), and [uartBridge](#) is not provided.

Transmitter Fibra is part of the Fibra product line of wired devices. Only accredited Ajax Systems partners can install, sell, and administer these devices.

Buy Transmitter Fibra

Functional elements

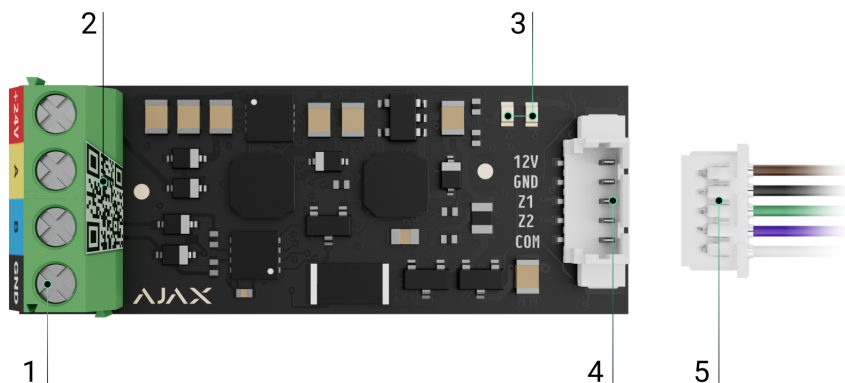

1. Input terminals for connecting the Fibra line to Transmitter Fibra.
2. QR code with the device ID for adding the module to the Ajax system.
3. LED indicators of the module.
4. Connector for a wired device.
5. Accessory 5-pin cable.

Terminals for connecting Transmitter Fibra to the hub:

- **+24V** – 24 V $\overline{=}$ power supply terminal.
- **A, B** – signal terminals.
- **GND** – power ground terminal.

Connector pins for connecting a wired device:

- **12V** – 10.5–15 V $\overline{=}$, up to 50 mA power supply output for a wired device.
- **GND** – ground.

- **Z1–Z2** – inputs for connecting a wired device.
- **COM** – common input for connecting signal contacts of a wired device.



Transmitter Fibra has 2 inputs (Z1 and Z2) to connect a wired device using the AATT (i.e., Alarm Alarm Tamper Tamper) scheme.

Operating principle







Transmitter Fibra is designed to integrate a third-party wired device into an Ajax system. The integration module receives information about alarms, malfunctions, and events from the device through a wired connection. After that, it sends the event to Hub Hybrid using the Fibra wired communication protocol. Then, Hub Hybrid sends notifications to users and the security company CMS (central monitoring station).



Transmitter Fibra is used to integrate panic or auxiliary buttons, indoor or outdoor motion detectors, as well as opening, vibration, glass break, fire, gas, or water leak detectors, etc.

The device type is specified in the settings of the zone to which the wired device is connected. The selected type determines the text of alarm notifications and events of the connected device, as well as event codes transmitted to the CMS.

Types of events of wired devices

Type	Icon	Meaning
Intrusion		Alarm when motion, opening, and other detectors are triggered.

Fire		Alarm when fire detectors are triggered.
Auxiliary alarm		Alarm when the auxiliary button is pressed.
Panic button		Alarm when the panic button is pressed.
Gas alarm		Alarm when gas concentration is exceeded.
Tamper alarm		Event of a detector or device tamper triggering.
Malfunction		An event caused by a malfunction of a connected detector or device.
Leakage		Alarm caused by flooding.

Custom		<p>The event type is customized by the user.</p> <div data-bbox="691 159 1422 304" style="border: 1px solid black; border-radius: 10px; padding: 10px;"><p> Not sent to the security company monitoring station and users via SMS.</p></div>
--------	---	---

Wired devices connection types

- Without EOL.
- EOL (connection with one resistor).
- 2EOL (connection with two resistors).
- 3EOL (connection with three resistors).
- Roller Shutter.

In the Ajax app, you can select the normal state (normally open or normally closed) for the terminal pairs: alarm, tamper, and malfunction. This allows connecting any potential-free “dry” contact detector of any configuration to Transmitter Fibra.

Fibra data transfer protocol

The integration module uses Fibra technology to transmit alarms and events. It is a wired data transfer protocol for fast and reliable two-way communication between the hub and integration module. Using the bus connection method, Fibra delivers alarms and events instantly, even if 100 devices are connected to the system.

Fibra supports block encryption featuring a dynamic key and verifies each communication session with devices to prevent sabotage and spoofing. The protocol provides for regular polling of devices by the hub at a specified frequency to control communication and display the state of system devices in Ajax apps.

Sending events to the monitoring station

The Ajax system can transmit alarms to both [PRO Desktop](#) monitoring app and the central monitoring station (CMS) in the formats of **SurGard (Contact ID)**, **SIA DC-09 (ADM-CID)**, **ADEMCO 685**, and [other protocols](#).

Transmitter Fibra can transmit the following events:

1. Alarm/restoration of the connected device.
2. Loss/recovery of communication between Transmitter Fibra, connected devices, and the hub.
3. Permanent deactivation/activation of Transmitter Fibra and connected devices.
4. One-time deactivation/activation of Transmitter Fibra and connected devices.
5. Short circuit on the line/power supply restoration of connected devices.
6. Short circuit of or damage to the line connecting third-party devices to Transmitter Fibra (for EOL connections).

When an alarm is received, the operator at the security company's monitoring station knows what happened and precisely where to dispatch a rapid response team. The addressability of Ajax devices allows sending events to PRO Desktop or the CMS, including the device type, its name, security group, and virtual room. Please note that the list of transmitted parameters might vary depending on the CMS type and the selected communication protocol for the monitoring station.



The device's ID and number can be found in its [states in the Ajax app](#)

Adding to the system



Transmitter Fibra is compatible only with [Hub Hybrid \(2G\)](#) and [Hub Hybrid \(4G\)](#). Only verified partners can add and configure Fibra devices in [Ajax PRO apps](#).

[Types of accounts and their rights](#)

Before adding a device

1. Install [Ajax PRO app](#) and sign in to the PRO account.
2. Add a hub that is compatible with Transmitter Fibra to the app. Configure the necessary settings and create at least one [virtual room](#).
3. Ensure that the hub is switched on and has an internet connection through Ethernet and/or a mobile network.
4. Ensure that the hub is disarmed and does not start updating by checking its status in the Ajax app.
5. Ensure that Transmitter Fibra is physically connected to the hub and is powered.

Connecting to the hub

There are two ways to add devices in the [Ajax PRO app](#): automatically and manually.

Automatically

Manually

To add a device automatically:

1. Open the [Ajax PRO app](#) and select the hub to which you want to add Transmitter Fibra.
2. Go to the **Devices**  tab and click **Add device**.
3. Select **Add all Fibra devices**. The hub will scan the Fibra lines. After scanning, all devices connected to the hub that have not been added to the system will be displayed.

4. Select the desired device from the list. Upon selection, the LED indicator will flash to identify this device.
5. Name the device, and select the room and security group if Group Mode is enabled. Click **Save**.

Once connected to the hub, the module will appear in the list of hub devices in the Ajax app. The device status update frequency in the list depends on the Jeweller/Fibra settings, with the default value of 36 seconds.



Transmitter Fibra works with only one hub. When connected to a new hub, the device stops sending events to the old one.

Adding the module to a new hub does not automatically remove it from the device list of the old hub. This must be done through the Ajax app.

Adding a connected wired device



In the Ajax system, each device connected to Transmitter Fibra occupies one slot within the hub's device limit.

1. In the Ajax PRO app, go to the **Devices**  tab.
2. Find **Transmitter Fibra** in the device list.
3. Click on the **Devices** menu under the integration module icon.
4. Click **Add Device**.
5. Assign a name to the device.
6. Select the wired zone to which the device will be physically connected.
7. Select a virtual room and a security group if the Group Mode is enabled.
8. Press **Add Device**. The device will be added within 30 seconds.



The device status update depends on the Jeweller/Fibra settings; the default value is 36 seconds.

If the connection attempt fails, verify that the wired connection is correctly set up before trying again. If the maximum number of devices (100 for Hub Hybrid) has already been added to the hub, you will receive an error notification while adding.

Malfunctions

When a Transmitter Fibra malfunction is detected, the Ajax app displays a malfunction counter on the device icon. All malfunctions are indicated in the module states. Fields with malfunctions will be highlighted in red.

A malfunction is displayed if connection with a hub is lost.

A malfunction of the connected device is displayed if:





- The device enclosure is open (tamper triggering).
- There is no connection between the integration module and the device (contacts damaged).
- Incorrect connection of resistors (resistor resistance error).
- Short circuit on the power supply line for the device.

Icons







The icons in the app display some module states. To access them:

















1. Sign in to the [Ajax app](#).
2. Select a hub.
3. Go to the **Devices**  tab.







Transmitter Fibra icons

Icon	Meaning
	Fibra signal strength – displays the signal strength between the hub and the integration module. Recommended value is 2–3 bars. Learn more
	A fire detector connected to Transmitter Fibra has registered an alarm.
	Transmitter Fibra has a malfunction. A list of malfunctions is available in the States of the integration module.
	Transmitter Fibra is disabled. Learn more
	Transmitter Fibra is disabled until the first event of disarming the system. Learn more

Icons of connected devices

Icon	Meaning
	Chime function is enabled.
 	Delay When Entering and/or Leaving is enabled.
	The device operates in the Always active mode.
	The device will work when Night Mode is enabled.
	The device state is OK. <i>Displayed for EOL, NC, NO, and Roller Shutter connections only.</i>

	<p>The device is short-circuited.</p> <p><i>Displayed for EOL, NC, NO, and Roller Shutter connections only.</i></p>
	<p>The device tamper state is OK.</p> <p><i>Displays for 2EOL and 3EOL connections only.</i></p>
	<p>Device tamper alarm.</p> <p><i>Displays for 2 EOL and 3 EOL connections only.</i></p>
	<p>The state of the intrusion sensors is OK.</p> <p><i>Displayed for 2EOL and 3EOL connections only.</i></p>
	<p>Intrusion alarm.</p> <p><i>Displayed for 2EOL and 3EOL connections only.</i></p>
	<p>The state of the auxiliary request button is OK.</p>
	<p>Alarm when the auxiliary button is pressed.</p>
	<p>The state of the panic button is OK.</p>
	<p>Alarm when the panic button is pressed.</p>
	<p>The state of the fire sensor is OK.</p>
	<p>The device has detected a fire alarm.</p>
	<p>The state of the gas sensor is OK.</p>
	<p>Alarm when the gas concentration is exceeded.</p>
	<p>The device state is OK.</p> <p><i>Displayed for 2EOL and 3EOL connections only.</i></p>
	<p>Device malfunction is detected.</p> <p><i>Displayed for 2EOL and 3EOL connections only.</i></p>
	<p>The state of the flooding sensor is OK.</p>
	<p>Alarm caused by the flooding.</p>

	The state of the device for which the custom type of event is selected is OK.
	The alarm of the device for which the custom type of event is selected.
	The device is automatically <u>disabled due to exceeding the number of alarms</u> .
	The device is automatically <u>disabled by the restoration timer</u> .
	The device is <u>disabled</u> by the system user.
	The device is <u>disabled</u> until the first event of disarming the system.

States

Transmitter Fibra states

The states include information about the integration module and its operating parameters. You can find the states of Transmitter Fibra in the Ajax apps:

1. Go to the **Devices**  tab.
2. Select **Transmitter Fibra** from the list.

Parameter	Meaning
Malfunction	<p>Clicking the  opens the list of the Transmitter Fibra malfunctions.</p> <p>The field is displayed only if a malfunction is detected.</p>
Fibra signal strength	<p>Fibra signal strength between Transmitter Fibra and the hub. The recommended value is 2–3 bars.</p> <p>Fibra is the protocol for transmitting Transmitter Fibra events and alarms.</p> <p><u>Learn more</u></p>

Connection via Fibra	<p>Connection status on the Fibra line between Transmitter Fibra and the hub:</p> <ul style="list-style-type: none"> • Online – the device is connected to the hub. Normal status. • Offline – the device is not connected to the hub. Check the device connection.
Line voltage	The voltage value on the Fibra line to which the integration module is connected.
Power Supply for Connected Detectors	<p>The status of the power supply for connected detectors 10.5–15 V$\overline{=}$, up to 50 mA:</p> <ul style="list-style-type: none"> • On – the power supply is enabled. • Off – the power supply is disabled.
Permanent Deactivation	<p>The status of the device permanent deactivation setting:</p> <ul style="list-style-type: none"> • No – the device operates in the normal mode and transmits all events. • Entirely – the device is completely excluded from the system operation by the hub admin. The device does not execute system commands and does not report alarms or other events. <p><u>Learn more</u></p>
One-Time Deactivation	<p>The status of the device one-time deactivation setting:</p> <ul style="list-style-type: none"> • No – the device operates in the normal mode. • Entirely – the device is completely excluded from the system operation until the first event of disarming the system. The device does not execute system commands and does not report alarms or other events. <p><u>Learn more</u></p>

Firmware	Device firmware version.
Device ID	Transmitter Fibra ID. Also available on the board of the integration module, the back of the casing, and its packaging.
Device No.	Number of the device loop (zone).
Line No.	The number of the Fibra line to which Transmitter Fibra is connected.

States of connected devices

The states display information about the device and its operating parameters. You can find the states of the device connected to Transmitter Fibra in the Ajax apps:

1. Go to the **Devices**  tab.
2. Find **Transmitter Fibra** in the list.
3. Click on **Devices** under the Transmitter Fibra icon.
4. Select the device from the list.

Parameter	Meaning
Malfunction	<p>Clicking the  opens the list of the connected wired device malfunctions.</p> <p>The field is displayed only if a malfunction is detected.</p>
Name of the connected wired device	<p>Connection status on the line between Transmitter Fibra and the connected wired device:</p> <ul style="list-style-type: none"> • Online – the device is connected to Transmitter Fibra. Normal status. • Offline – the device is not connected to Transmitter Fibra. Check the device connection.

<p>Device state</p> <p>Displayed for Without EOL, EOL, and Roller Shutter connection types</p>	<p>The status of the connected wired device:</p> <ul style="list-style-type: none"> • OK – the device is operating normally. • Alert – the device has detected an alarm. • Contacts Damaged – displayed if there is a broken connection with the device. State is only available in case of an EOL NC connection. • No data – displayed when no information has been received from the hub yet.
<p>Tamper sensor</p> <p>Displayed for 2EOL and 3EOL connection types</p>	<p>Tamper status of the connected wired device:</p> <ul style="list-style-type: none"> • OK – the tamper is operating normally. • Alert – the alarm of a device tamper. • No data – displayed when no information has been received from the hub yet.
<p>“Name of the selected event type” sensor</p> <p>Displayed for 2EOL and 3EOL connection types</p>	<p>The status of the connected wired device:</p> <ul style="list-style-type: none"> • OK – the connected device is operating normally. • Alert – the connected device has detected an alarm. • Shorted out – terminals to which the device is connected are short-circuited. • No data – displayed when no information has been received from the hub yet.
<p>Always Active</p>	<p>If the option is enabled, the device connected to Transmitter Fibra is constantly armed and reports alarms.</p> <p>You can configure the option only for the Intrusion and Custom event types, as well as for the Roller Shutter input type. Devices for which other event types are selected are always active by default.</p> <p>Learn more</p>

<p>Device resistance</p> <p>Displayed for EOL, 2EOL, and 3EOL connection types</p>	<p>The total resistance of the resistor(s) connected to the device is measured automatically.</p> <p>Values can also be set manually in 100-ohm increments.</p>
<p>Permanent Deactivation</p>	<p>Allows the user to disable the device without removing it from the system.</p> <p>Two options are available:</p> <ul style="list-style-type: none">• No – the device operates in the normal mode and transmits all events.• Entirely – the device is completely excluded from the system operation by the hub admin. The device does not execute system commands and does not report alarms or other events. <p><u>Learn more</u></p> <p>You can also separately configure the device disconnection:</p> <ul style="list-style-type: none">• By number of alarms – the device is automatically disconnected by the system when the set number of alarms is exceeded.• By timer – the device is automatically disconnected when the restoration timer expires. <p>The feature is configured in the Ajax PRO apps.</p> <p><u>Learn more</u></p>
<p>One-Time Deactivation</p>	<p>The status of the device one-time deactivation setting:</p> <ul style="list-style-type: none">• No – the device operates in the normal mode.• Entirely – the device is completely excluded from the system operation until the first event of disarming the system. The device

does not execute system commands and does not report alarms or other events.

[Learn more](#)

Alarm Reaction

Operating Mode

Shows how the detector reacts to alarms:

- **Instant Alarm** – the armed detector immediately reacts to a threat and raises the alarm.
- **Entry/Exit** – when a delay is set, the armed device starts the countdown and doesn't raise the alarm even if triggered until the countdown ends.
- **Follower** – the detector inherits the delays from Entry/Exit detectors. However, when the Follower is triggered individually, it immediately raises the alarm.

Delay When Entering, s

Delay time when entering: 5 to 120 seconds.

Delay when entering (alarm activation delay) is the time the user has to disarm the security system after entering the secured area.

[Learn more](#)

Delay When Leaving, s

Delay time when leaving: 5 to 120 seconds.

Delay when leaving (arming delay) is the time the user has to leave the secured area after arming.

[Learn more](#)

Arm in Night Mode

When this option is enabled, the device will enter the armed mode when the system is set to **Night Mode**.

Night Mode Delay When Entering, s

Delay time when entering in **Night Mode**: 5 to 120 seconds.



Delay when entering (alarm activation delay) is the time the user has to disarm the security

	system after entering the secured area. Learn more
Night Mode Delay When Leaving, s	Delay when leaving in Night Mode : 5 to 120 seconds. Delay when leaving (arming delay) is the time the user has to leave the secured area after arming. Learn more
Wired input	Transmitter Fibra zone number to which a wired device is connected.
Device No.	Device loop (zone) number.

Settings

Transmitter Fibra settings

To change the Transmitter Fibra settings in the Ajax app:

1. Go to the **Devices**  tab.
2. Select **Transmitter Fibra** from the list.
3. Go to **Settings** by clicking on the  icon.
4. Set the required settings.
5. Click **Back** to save the new settings.

Settings	Meaning
Name	Name of the module. Displayed in the list of hub devices, SMS text, and notifications in the events feed. To change the name of the device, click on the text field.

	The name can contain up to 12 Cyrillic characters or up to 24 Latin characters.
Room	<p>Selecting the virtual room to which Transmitter Fibrá is assigned.</p> <p>The room name is displayed in the text of SMS and notifications in the events feed.</p>
Power Supply for Connected Detectors	<p>Enable power supply 10.5–15 V$\overline{=}$, up to 50 mA for the connected detector.</p> <p>The option is disabled by default.</p>
Connected Detectors Current Consumption	<p>Set the current consumption when the power supply for the connected detector is enabled. Adjust the current value from 10 to 50 mA.</p> <div style="border: 1px solid black; border-radius: 10px; padding: 10px; margin-top: 10px;"> <p> Set the maximum consumption for devices that require power supply from the integration module. This value helps to determine if all devices have enough power supply from the line in current system configuration.</p> </div>
Alert with a siren if power supply for detectors is shorted out	<p>When this option is enabled, the sirens added to the system will activate in case of a short circuit of the power supply for detectors.</p> <p>The option is enabled by default.</p>
Fibra Signal Strength Test	<p>Switches the device to the Fibrá signal strength testing mode.</p> <p><u>Learn more</u></p>
User Guide	Opens Transmitter Fibrá user guide in the Ajax app.
Permanent Deactivation	Allows the user to deactivate the device without removing it from the system.

	<p>Two options are available:</p> <ul style="list-style-type: none"> • No – the device operates in the normal mode and transmits all events. • Entirely – the device does not execute system commands and does not participate in automation scenarios, and the system ignores alarms and other device notifications. <p><u>Learn more</u></p>
<p>One-Time Deactivation</p>	<p>Allows the user to disable events of the device until the first disarm.</p> <p>Two options are available:</p> <ul style="list-style-type: none"> • No – the device operates in the normal mode. • Entirely – the device is completely excluded from the operation of the system until the first disarm. The device does not execute system commands and does not report alarms or other events. <p><u>Learn more</u></p>
<p>Delete Device</p>	<p>Unpairs the device, disconnects it from the hub, and deletes its settings.</p>

Settings of connected devices

To change the connected device settings, in the Ajax app:

1. Go to the **Devices**  tab.
2. Find **Transmitter Fibra** in the list.
3. Click on **Devices** under the Transmitter Fibra icon.
4. Select the device from the list.

5. Go to **Settings** by clicking on the  icon.

6. Set the parameters.

7. Click **Back** to save the new settings.

Without EOL

EOL

2EOL

3EOL

**Roller
Shutter**

Setting	Meaning
Name	<p>Wired device name. Displayed in the list of hub devices, SMS text, and notifications in the events feed.</p> <p>To change the name, click on the text field.</p> <p>The name can contain up to 12 Cyrillic characters or up to 24 Latin characters.</p>
Room	<p>Selecting the device's virtual room.</p> <p>The room name is displayed in the text of SMS and notifications in the event feed.</p>
Input type	<p>Selecting the connection type of a third-party device:</p> <ul style="list-style-type: none">• Without EOL• EOL• 2EOL• 3EOL• Roller Shutter
Default State	<p>Selecting the normal contact state of the connected device:</p> <ul style="list-style-type: none">• Normally closed

	<ul style="list-style-type: none"> • Normally open
Sensor Mode	<p>Selecting the sensor mode of the connected device:</p> <ul style="list-style-type: none"> • Notify of Alarms • Switch Arming Modes
Arm Switch Settings	<p>Settings to configure arm switch if the Switch Arming Modes option is selected for Sensor Mode:</p> <ul style="list-style-type: none"> • selecting arming Preset Action • selecting Security Objects to be controlled by KeyArm
Type of Event	<p>Selecting the event type of the connected device:</p> <ul style="list-style-type: none"> • Intrusion • Fire • Auxiliary alarm • Panic button • Gas alarm • Tamper alarm • Malfunction • Leakage • Custom (not sent to users via SMS and to the security company monitoring station) <p>The text of notifications in the event feed and SMS, as well as the code transmitted to the security company monitoring station depends on the selected event type.</p>
Operating Mode	<p>The operating mode of the connected device:</p>

	<ul style="list-style-type: none"> • Bistable – for example, an opening detector. After an alarm, a restoration event is not sent if the detector returns to the normal state. • Pulse – for example, a motion detector. After an alarm, no restoration message is sent if the detector returns to a normal state. <p>Be sure to set a type that matches the connected device.</p> <p>The pulsed detector in the bistable mode generates unnecessary restoration events.</p> <p>A bistable detector in pulsed mode, on the contrary, will not send restoration events.</p>
Always Active	<p>If the option is enabled, the device connected to Transmitter Fibra is constantly armed and reports alarms.</p> <p>You can configure the option only for the Intrusion and Custom event types and for the Roller Shutter input type. Devices for which other event types are selected are always active by default.</p> <p><u>Learn more</u></p>
Pulse time	<p>Pulse time of a device for detecting an alarm:</p> <ul style="list-style-type: none"> • 20 ms. • 100 ms (by default). • 1 s. <p>An alarm will be activated if the pulse from the device lasts longer than specified in this setting. This can be used to filter false triggerings.</p>
Alert with a siren if alarm detected	<p>If the option is enabled, the <u>sirens</u> connected to the system are activated when an alarm is detected.</p>

Chime Settings	<p>Opens the Chime settings. The function works only for bistable devices.</p> <p>Notifications will not work for sensors in pulse mode or Always active mode.</p> <p>Learn more</p>
Alarm Reaction	
Operating Mode	<p>Specify how this device will react to alarms:</p> <ul style="list-style-type: none"> • Instant Alarm – the armed detector immediately reacts to a threat and raises the alarm. • Entry/Exit – when a delay is set, the armed device starts the countdown and doesn't raise the alarm even if triggered until the countdown ends. • Follower – the detector inherits the delays from Entry/Exit detectors. However, when the Follower is triggered individually, it immediately raises the alarm.
Delay When Entering, s	<p>Delay time when entering: 5 to 120 seconds.</p> <p>Delay when entering (alarm activation delay) is the time the user has to disarm the security system after entering the secured area.</p> <p>Learn more</p>
Delay When Leaving, s	<p>Delay time when leaving: 5 to 120 seconds.</p> <p>Delay when leaving (arming delay) is the time the user has to leave the secured area after arming the system.</p> <p>Learn more</p>
Arm in Night Mode	<p>If the option is enabled, the device connected to the integration module will switch to armed mode when the system is set to Night Mode.</p> <p>Learn more</p>

Night Mode Delay When Entering, s	<p>Delay time when entering in Night Mode: 5 to 120 seconds.</p> <p>Delay when entering (alarm activation delay) is the time the user has to disarm the security system after entering the secured area.</p> <p><u>Learn more</u></p>
Night Mode Delay When Leaving, s	<p>Delay when leaving in Night Mode: 5 to 120 seconds.</p> <p>Delay when leaving (arming delay) is the time the user has to leave the secured area after arming.</p> <p><u>Learn more</u></p>
Permanent Deactivation	<p>Allows the user to disable the device without removing it from the system.</p> <p>Two options are available:</p> <ul style="list-style-type: none">• No – the device operates in the normal mode and transmits all events.• Entirely – the device is completely excluded from the system operation by the hub admin. The device does not execute system commands and does not report alarms or other events. <p><u>Learn more</u></p> <p>You can also separately configure disconnecting of the device:</p> <ul style="list-style-type: none">• By number of alarms – the device is automatically disconnected by the system when the set number of alarms is exceeded.• By timer – the device is automatically disconnected when the restoration timer expires. <p>The feature is configured in the Ajax PRO apps.</p> <p><u>Learn more</u></p>

One-Time Deactivation

Allows the user to disable events of the device until the first event of disarming the system.

Two options are available:

- **No** – the device operates in the normal mode and transmits all events.
- **Entirely** – the device is completely excluded from the system operation until the first event of disarming the system. The device does not execute system commands and does not report alarms or other events.

[Learn more](#)



Indication

Section is work-in-progress.

Functionality testing

The Ajax system offers several types of tests to help select the correct installation place for the devices. The tests do not start immediately; however, the waiting time does not exceed the duration of one “hub—device” polling interval. You can check and configure the polling interval in the hub settings (**Hub** → **Settings**  → **Jeweller/Fibra**).

To run a test, in the Ajax app:

1. Select the required hub.
2. Go to the **Devices**  tab.
3. Select **Transmitter Fibra** from the list.
4. Go to the **Settings** .
5. Run the [Fibra Signal Strength Test](#).

Device placement

Follow these recommendations when designing the system project for an object. Only professionals should design and install the Ajax system. The list of authorized Ajax partners is [available here](#).



Installing into a wired device

Transmitter Fibra should be installed inside the wired detector casing. The module requires a space with the following minimum dimensions: 40 × 15 × 12.2 mm. Installation inside the wired detector casing protects Transmitter Fibra from external impacts and secures it with a tamper alarm.

How not to install Transmitter Fibra

1. In places where temperature and humidity levels exceed the permissible limits, as this can damage the module.
2. In places with low or unstable Fibra signal strength, as this might cause a loss of connection with the hub.

Fibra signal strength

The Fibra signal strength is determined by the number of undelivered or corrupted data packages over a certain period of time. The icon  on the **Devices**  tab indicates the signal strength:

- **Three bars** – excellent signal strength.
- **Two bars** – good signal strength.
- **One bar** – low signal strength, stable operation is not guaranteed.
- **Crossed out icon** – no signal.

[What is Fibra Signal Strength Test](#)

Lines Power Supply Test

The test simulates the maximum energy consumption of devices connected to the hub. If the system passes the test successfully, all its devices have enough power supply in any situation.



If the connected third-party device requires power supply from Transmitter Fibra, make sure you set the correct Connected Detectors Current Consumption value in the Transmitter Fibra settings. It is required for the accurate Lines Power Supply Test results.

What is Lines Power Supply Test

After the test, the app displays a notification with the status of each line:

- Test passed.
- Test passed with malfunctions.
- Test failed.

Designing

It is crucial to design the system project properly to ensure the correct installation and configuration of the devices. The design must consider the number and types of devices at the object, their exact locations and installation heights, the length of wired Fibra lines, the type of cable used, and other parameters. Refer to [the article](#) to learn tips for designing the Fibra system project.

Cable length and type

For Transmitter Fibra

The maximum range of a wired connection using the **Beam (Radial wiring)** topology is 2,000 meters, and using the **Ring** topology – 500 meters.

Recommended cable types:

- U/UTP cat.5, 4 × 2 × 0.51 with copper conductor.
- Signal cable 4 × 0.22 with copper conductor.



Please note, the wired connection range might vary if other cable types are used. As of now, no other cable types have been tested.

For wired devices of third-party manufacturers

The maximum cable length for connecting third-party devices to Transmitter Fibra is 30 meters.

- **Recommended cable type** – Signal cable 4 × 0.22 with copper conductor.



To connect a wired device to Transmitter Fibra, we recommend using the accessory 5-pin cable. It has the required connector and is designed to place the integration module inside the wired detector casing.

Verification using a calculator

To ensure that the project is designed correctly and the system functions as intended in practice, we have developed a [Fibra power supply calculator](#). It helps to check the communication quality and cable length for wired Fibra devices when designing the system project.

Preparing for installation

Cable arrangement

Before laying cables, check the electrical and fire safety regulations applicable in your region. Strictly follow these standards and regulations. Tips for cable arrangement are available in [this article](#).

Cable routing

Before beginning the installation, we strongly advise reviewing the [Device placement](#) section thoroughly. Stick to the outlined system project without deviation. Violation of the basic Transmitter Fibra installation rules and the recommendations of this manual may lead to incorrect operation, as well as loss of connection with the device. Tips for cable routing are available in [this article](#).

Preparing cables for connection

First, remove the insulation layer and strip the cable with a special insulation stripper. The ends of the wires inserted into the device terminals must be tinned or crimped with a sleeve. It ensures a reliable connection and protects the conductor from oxidation. Tips for preparing the cables are available in [this article](#).

Installation

1. Turn off the power of lines in the [Ajax PRO app](#):

- **Hub** → **Settings** ⚙️ → **Lines** → **Lines Power Supply**.

2. Route the cable to connect Transmitter Fibra to the hub casing. Connect the wires to the required hub line.

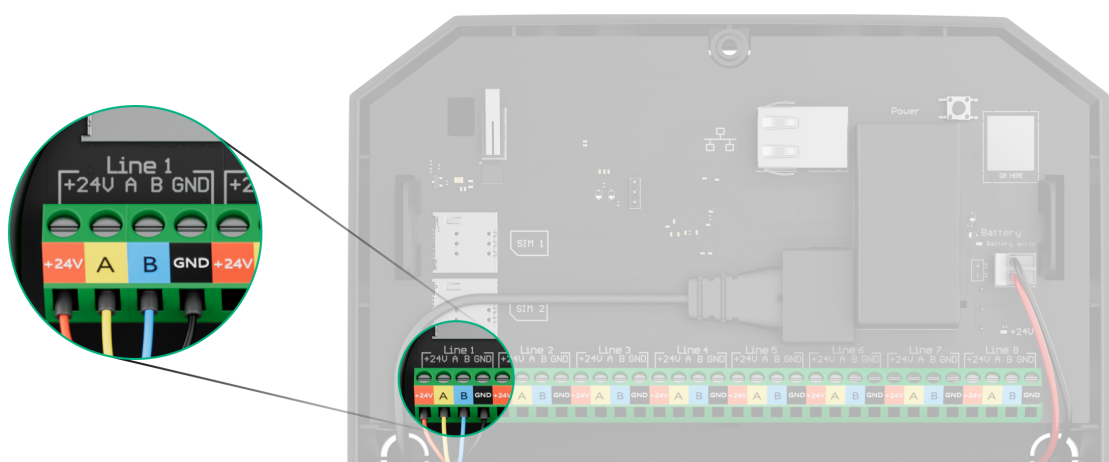

+24V – 24 V= power terminal.

A, B – signal terminals.

GND – ground.

3. Prepare cable holes in the wired detector casing, inside which Transmitter Fibra will be installed.
4. Connect the wires to the Transmitter Fibra input terminals according to the diagram below. Ensure the correct polarity and order of the wire connections. Firmly secure the cable to the terminals.



1. If Transmitter Fibra is not the last device on the Fibra line, prepare a second cable in advance. Connect the wires to the Transmitter Fibra terminals according to the figure below.

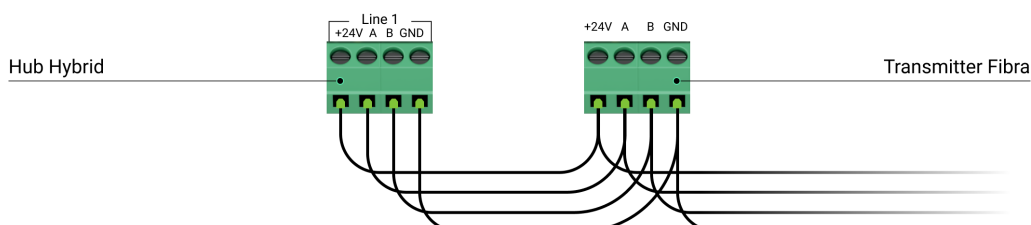

2. If Transmitter Fibra is the last device on the line and you are using the **Beam (Radial) connection**, install a terminating resistor on the two contacts by connecting it to the signal terminals of the integration module. Terminating resistor (120 Ohm) is included in the hub complete set.

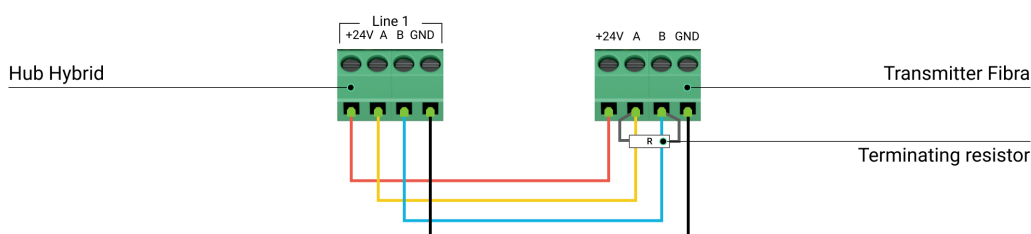

5. Connect the bundled accessory 5-pin cable to the Transmitter Fibra output terminal.
6. Connect the wires to the output terminals of the third-party device. The wiring diagram can be found in the user manual provided by the manufacturer of the wired device. Ensure the correct polarity and order of the wire connections. Firmly secure the cable to the terminals.



Carefully read the manufacturer's instructions before connecting the device to Transmitter Fibra.

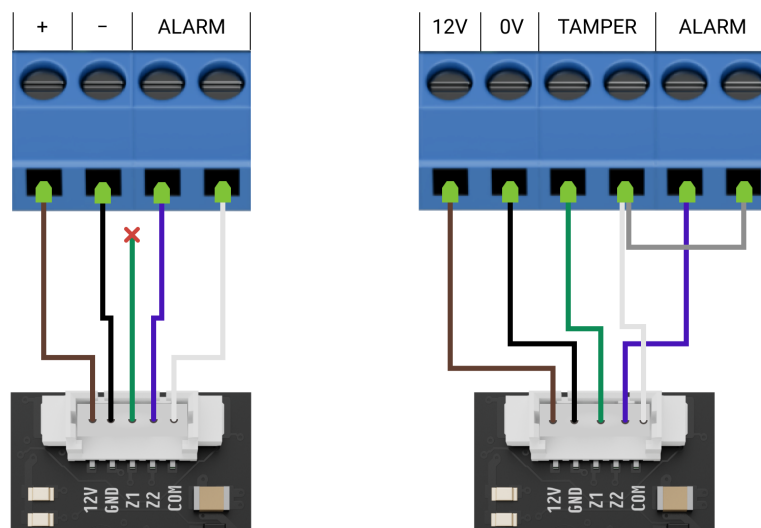

Transmitter Fibra has 2 inputs (Z1 and Z2) to connect the wired device using the AATT (i.e., Alarm Alarm Tamper Tamper) scheme.

7. Turn on the lines power supply in the [Ajax PRO app](#):

- **Hub** → **Settings**  → **Lines** → **Lines Power Supply**.

8. [Add Transmitter Fibra to the hub](#).

9. [Add a wired device to the system](#).

10. Run the module [functionality testing](#).

Maintenance

Transmitter Fibra does not require maintenance when mounted in the wired device casing.

Technical specifications

[All technical specifications of Transmitter Fibra](#)

[Compliance with standards](#)

Complete set

1. Transmitter Fibra.
2. Accessory 5-pin cable.
3. Quick start guide.

Warranty

Warranty for the Limited Liability Company "Ajax Systems Manufacturing" products is valid for 2 years after the purchase.

If the device does not function correctly, please contact Ajax Technical Support first. In most cases, technical issues can be resolved remotely.

[Warranty Obligations](#)

[User Agreement](#)

Contact Technical Support:

- [Email](#)
- [Telegram](#)

Subscribe to the newsletter about safe life. No spam

Subscribe