

# **Keyboard User's Manual**

**Version 1.0.0**

# Table of Contents

1	Features and Specifications .....	7
1.1	Features .....	7
1.2	Front Panel .....	7
1.3	Rear Panel .....	9
1.3.1	NKB1000 Series .....	9
1.3.2	KB1000 Series .....	9
1.3.3	KBD1000 Series .....	9
1.4	Port Features .....	10
1.5	Power .....	10
2	Menu Operation .....	11
2.1	Boot up and Shut down .....	11
2.1.1	Boot up .....	11
2.1.2	Shut Down .....	11
2.2	Main Menu List .....	11
2.3	Menu Operation .....	12
2.3.1	System .....	12
2.3.2	Control point .....	14
2.3.3	Account .....	15
2.3.4	Config .....	16
2.3.5	Version .....	17
2.3.6	Model .....	17
2.4	Zones .....	18
3	Keyboard Control DVR .....	19
3.1	Connection .....	19
3.1.1	RS232 Serial Port Connection .....	19
3.1.2	Via RS485 Connection .....	19
3.1.3	Multi-keyboard link via RS485 .....	19
3.2	Network Connection (For network keyboard only) .....	20
3.2.1	RJ45 port connection .....	20

3.3	DVR and Keyboard Setup .....	21
3.3.1	DVR Setup.....	21
3.3.2	Network Connection Setup .....	21
3.4	Operation .....	22
3.4.1	Login.....	22
3.4.2	Logout .....	22
3.4.3	Playback .....	22
3.4.4	Record.....	22
3.4.5	PTZ Control and Video Color .....	22
3.4.6	Tour .....	23
3.4.7	1-Window/Multiple-Window Switch .....	23
4	Network Keyboard Control Speed Dome .....	24
4.1	Cable Connection .....	24
4.2	Keyboard Setup .....	24
4.3	Operation .....	24
4.3.1	Speed Dome Menu .....	24
4.3.2	Iris/Zoom/Focus.....	25
4.3.3	Preset.....	25
4.3.4	Scan .....	25
4.3.5	Pan .....	26
4.3.6	Tour .....	26
4.3.7	Pattern.....	27
5	Keyboard Control NVS .....	28
5.1	Connection.....	28
5.2	Keyboard Setup .....	28
5.3	Operation .....	28
5.3.1	Login.....	28
5.3.2	Exit.....	28
5.3.3	1-Window/Multiple-Window Switch .....	28
6	Keyboard Upgrade.....	30
6.1	Control Keyboard Upgrade .....	30
6.2	Network Keyboard Upgrade.....	30

7	Make COM Cable.....	31
7.1	Make RS232 COM Cable.....	31
7.2	Make RS485 COM Cable.....	31
7.3	25-pin Port and Switch Box Connection .....	31

## **Welcome**

Thank you for purchasing our keyboard!

This operating manual is designed to be a reference tool for the operation of your keyboard.

Here you can find information about this keyboard features and functions, as well as a detailed menu tree.

Before operation please read the following safeguards and warnings carefully!

Please keep this user's manual well for future reference!

## **Important Safeguarding and Warnings**

All installation and operation should conform to your local electrical safety codes.

We assume no liability or responsibility for all the fires or electrical shock caused by improper handling or installation

All the examination and repair should be done by the qualified service engineers.

We are not liable for any problems caused by unauthorized modifications or attempted repair.

# 1 Features and Specifications

## 1.1 Features

This series keyboard has the following features

- One keyboard can control multiple DVRs, or you can use multiple keyboards to control one DVR.
- Support dome operation.
- Support RS485 port and RS232 port.
- Support PTZ operation via joystick
- Support all operations you get from DVR front panel function keys
- Support keyboard lock function
- Support multiple-level operation rights
- Support cascade connection
- Support single or multiple DVRs's menu setup
- On-screen menu, user-friendly procedure. It is very easy for you to operate

Besides above mentioned features, network keyboard also has the following features:

- Can control network video server and network video decoder
- Support network ports connection

## 1.2 Front Panel

The keyboard front panel is shown as below. See Figure 1-1.

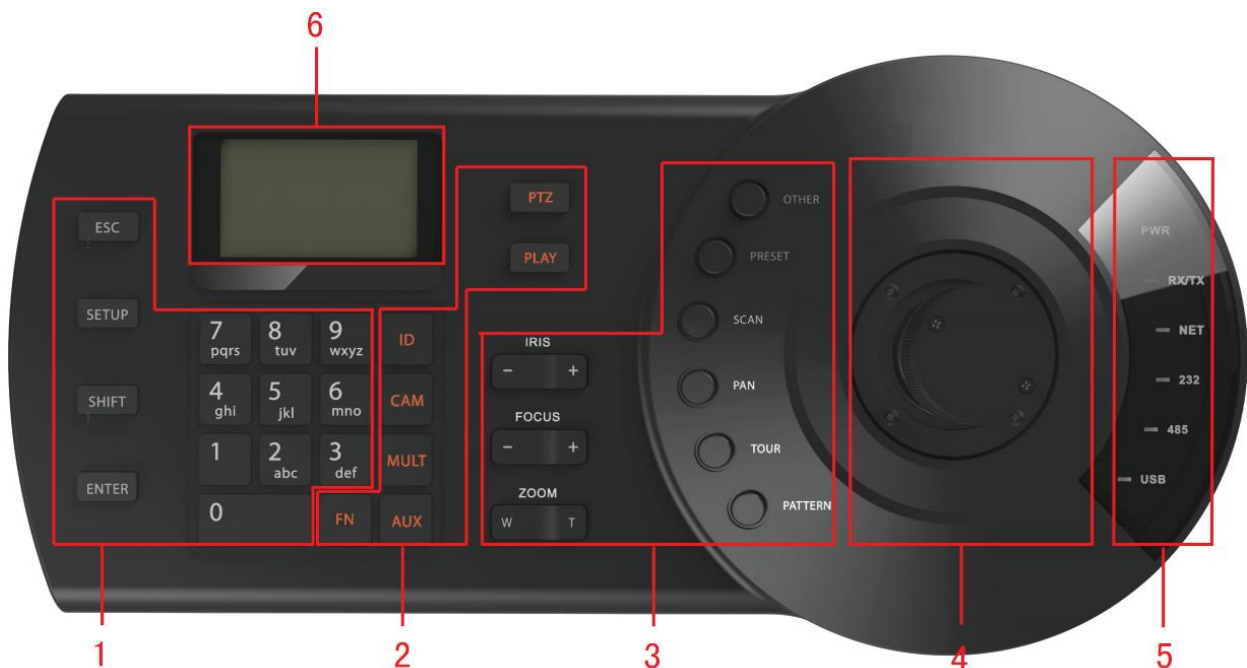

Figure 1-1

Please refer to the following sheet for detailed information.

SN	Note	Icon	Button Name	Function
1	General function panel	ESC	ESC	Cancel current operation In playback mode, click this key to go back dynamic surveillance mode.
		SETUP	Main menu shortcut button	Go back to main menu.
		SHIFT	Change input method	Switch between input methods
		ENTER	Confirm button	Confirm current operation
		0~9	Character and numerals	Switch between numeral/characters, click Shift to switch.
2	DVR control panel	ID	ID shortcut	Shortcut key to go to ID zone search
		CAM	Device channel number	Control DVR channel.
		MULT	Split button	Control DVR window split
		AUX	Auxiliary	Go to video color interface and open DVR local PTZ interface.
		FN	Function key	Work with the number buttons. 【FN】 +1: Go to DVR assistant interface. 【FN】 +2: Tour
		PTZ	PTZ button	Control channel PTZ.
		PLAY	Playback button	Control DVR playback
3	Speed dome control panel	IRIS	iris	Control iris.
		FOCUS	focus	Control focus
		ZOOM	zoom	Control zoom.
		OTHER	Speed dome menu	Go to speed dome menu.
		PERSET	Preset	Go to preset setup interface.
		SCAN	Scan	Go to scan setup interface.
		PAN	Pan	Go to pan setup menu.
		TOUR	Tour	Go to tour setup menu.
		PATTERN	Pattern	Go to pattern setup menu.
4	Joystick	-	-	Aux menu and function operation.
5	Indicator light panel	PWR	Power indicator light	The light is on when the keyboard is properly connected to the power supplying.
		TR/TX	Network data receive and send indicator light	The light is flashing when the keyboard is connected to the network.
		NET	Network indicator light	The light is on when the device is connected to the network.
		232	RS232 indicator light	The light is flashing when there is 232 data transmission.
		485	RS485 indicator light	The light is flashing when there is 485 data transmission.
		USB	USB indicator light	The light is on when the keyboard is connected to the USB device. <ul style="list-style-type: none"> <li>For NKB1000 series product, the light is on when the keyboard is connected to the PC.</li> <li>For KB1000 and KBD1000 series product, the light is on when the keyboard is connected to the flash disk.</li> </ul>
6	LCD	-	-	OSD menu



## 1.3 Rear Panel

### 1.3.1 NKB1000 Series

Please refer to Figure 1-2 for keyboard port information.

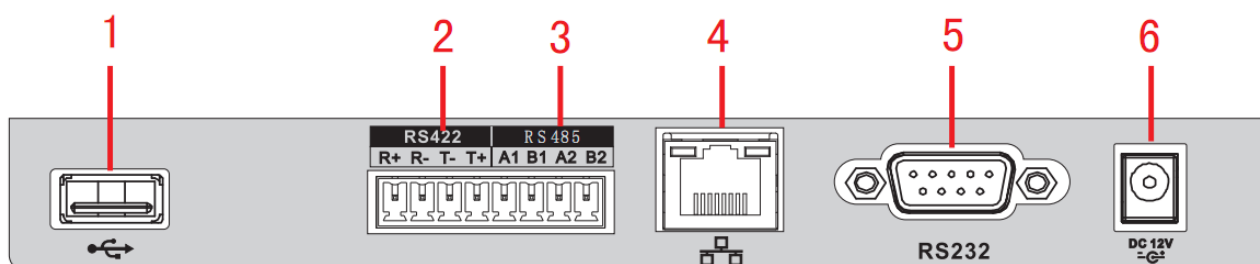

Figure 1-2

Please refer to the following sheet for detailed information.

SN	Name
1	USB port
2	RS422 port
3	RS485 port
4	Network port
5	RS232 port
6	Power socket

### 1.3.2 KB1000 Series

Please refer to Figure 1-3 for keyboard port information.

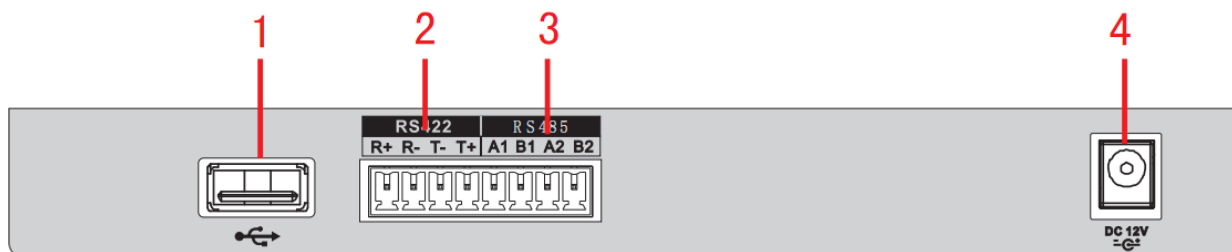

Figure 1-3

Please refer to the following sheet for detailed information.

SN	Name
1	USB port
2	RS422 port
3	RS485 port
4	Power socket

### 1.3.3 KBD1000 Series

Please refer to Figure 1-4 for keyboard port information.

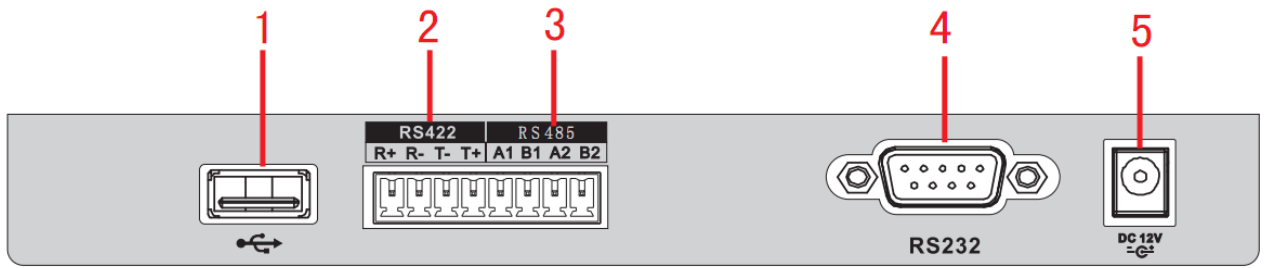

Figure 1-4

Please refer to the following sheet for detailed information.

SN	Name
1	USB port
2	RS422 port
3	RS485 port
4	RS232 port
5	Power socket

## 1.4 Port Features

- RS232 port can directly connect to device if there is RS232 port. The distance should be within 10m.
- RS485 transmission distance is 1200 m (9600bps) , max 3000m actually.
- For network keyboard series, please connect to the network port to connect the DVR or the network speed dome.

## 1.5 Power

The keyboard uses +12V DC, you can use +12V adapter included in the accessories bag.

## 2 Menu Operation

### 2.1 Boot up and Shut down

#### 2.1.1 Boot up

Connect the keyboard to the proper power supplying source. The power indicator light is on. You can see the welcome interface after the device properly booted up.

Click **【ENTER】** and **【SETUP】** button to go to the following interface. See Figure 2-1.

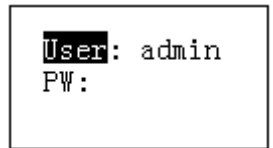

Figure 2-1

Input user name and password, system goes to the main menu.

#### Note

Factory default user names are: **admin/default/guest**. The password is: **888888**.

The **default** can not add/delete user, modify user rights or manage rights.

The **guest** can only operate control points. There are no other rights.

#### 2.1.2 Shut Down

After you exit the system, unplug the power cable to turn off the device.

### 2.2 Main Menu List

The main menu list is shown as below. See Figure 2-2.

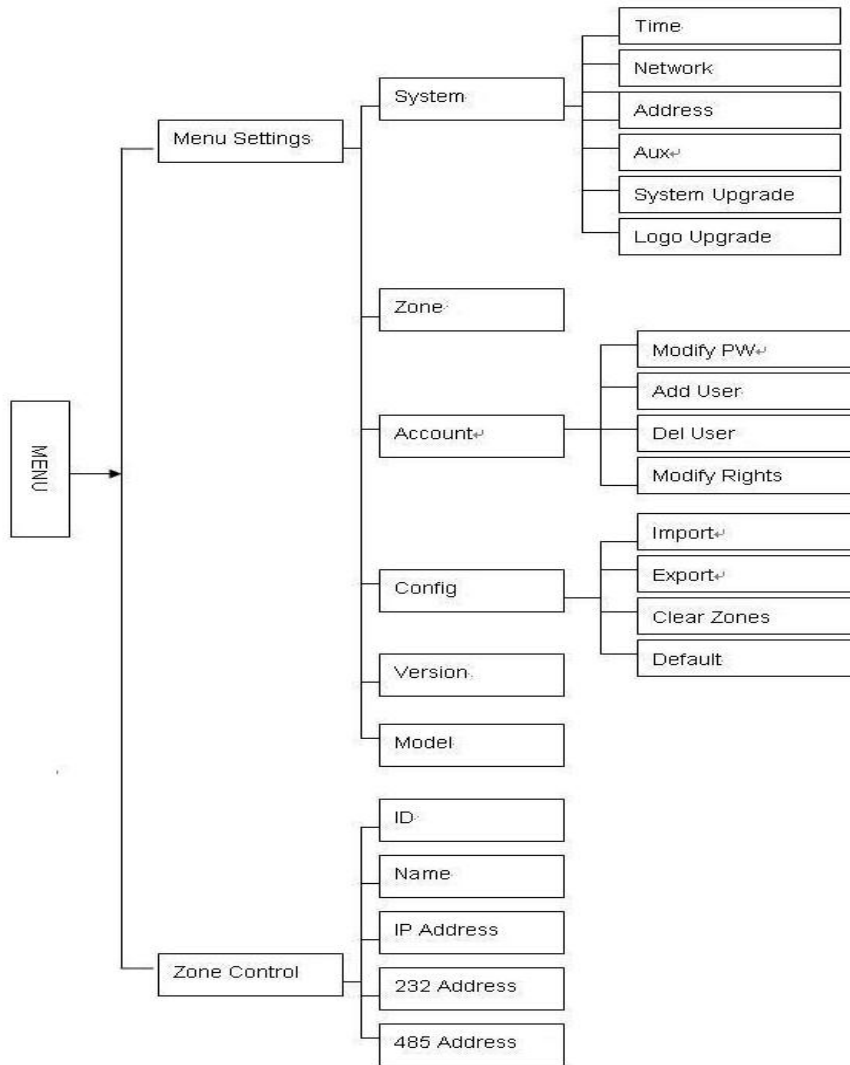

Figure 2-2

## 2.3 Menu Operation

Use the joystick on keyboard to move up/down/left/right to select items.

Use keyboard to input number or character to set parameters.

Click **【ENTER】** to confirm current operation. Click **【ESC】** to exit.

### 2.3.1 System

The system manager includes time setup, network setup, address setup, aux setup, system update and logo update. See Figure 2-3.

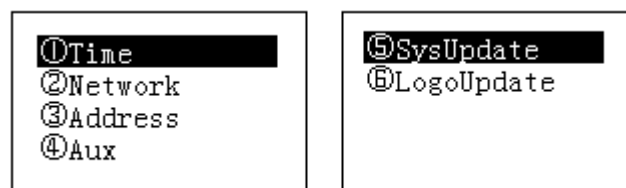

Figure 2-3

### 2.3.1.1 Time

It is to set keyboard system time. It includes year, month, date, minute and second. See Figure 2-4.

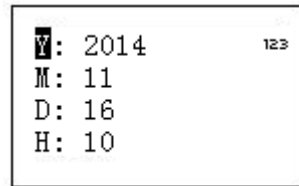

Figure 2-4

### 2.3.1.2 Network

It is to set keyboard IP address, subnet mask, gateway, port(Default setup is 37777) and etc. Please set according to your actual situation. See Figure 2-5.

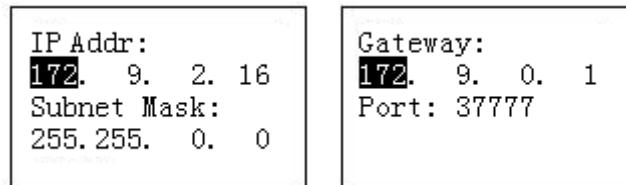

Figure 2-5

### 2.3.1.3 Address

The address value ranges from 0 to 255. The default setup is 0. When there is cascade connection, the 0 has the highest priority and the 255 has the lowest priority. See Figure 2-6.

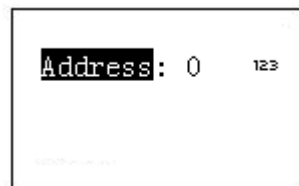

Figure 2-6

### 2.3.1.4 Aux

It is to set screen backlight and auto logout function. See Figure 2-7.

- Backlight: It is to set screen backlight. The options are: on/off.
- Auto logout: After you enable the auto logout function, system can auto logout when there is no operation for specified time.

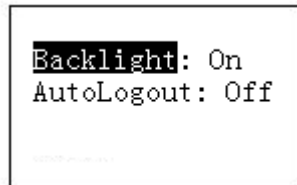

Figure 2-7

### 2.3.1.5 System Update



**Do not remove the flash disk during the whole process. Otherwise it may result in upgrade failure and the network keyboard can not boot up properly.**

The flash disk upgrade function is for KB1000 or KBD1000 series product. Please select system update interface and click **【ENTER】** button to go to the update interface. Follow the prompt to click the **【ENTER】** to update.

### 2.3.1.6 Logo update

The logo upgrade function is for KB1000 or KBD1000 series product. You can update logo file if necessary.

## 2.3.2 Control point

It is to set control point information. See Figure 2-8. All the items listed below shall be set. You can use the ID, device name, COM address or the IP address to search a device easily in chapter 2.4.

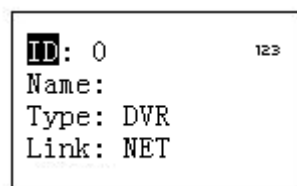

Figure 2-8



**The information you input here shall be unique. Otherwise, system can not save the setup.**

- ID: It is device ID number so that you can recognize device quickly.
- Name: Customized device name.
- Type: Device type. The options include: SD/NVS/DVR.

- Link: The options include: NET/RS232/RS485. Please select the type and set the corresponding parameters. The interface is shown as in Figure 2-9.

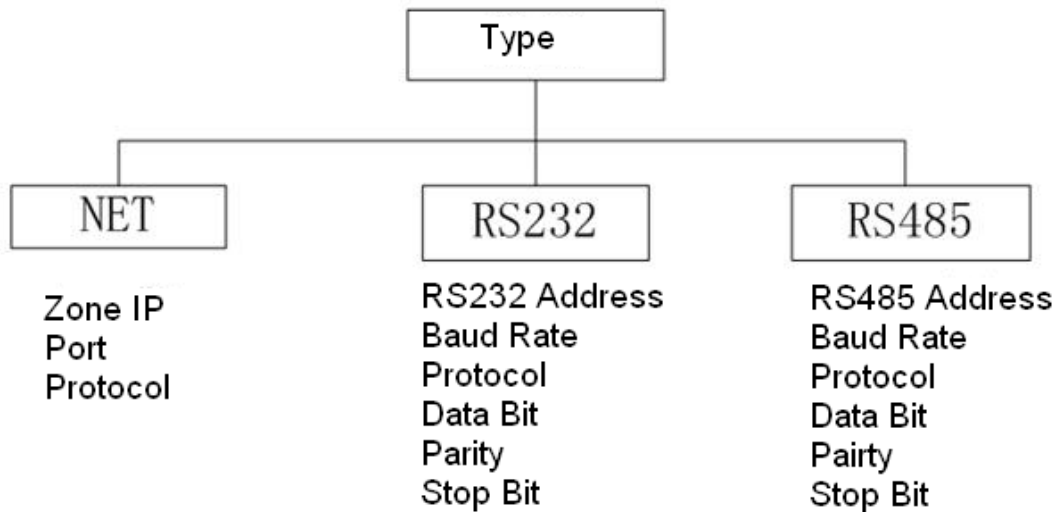

Figure 2-9



**PLEASE MAKE SURE THE COM TYPE AND THEN PARAMETERS YOU SET HERE IS THE SAME AS THE ACTUAL SITUATIONS. OTHERWISE, THE KEYBOARD CAN NOT CONTROL THE DEVICE!**

### 2.3.3 Account

Here is for you to change password, add user, and delete user and its rights. See Figure 2-10.

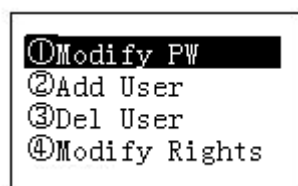

Figure 2-10

#### 2.3.3.1 Change password

Select a user and then input new password. Usually we recommend 6-digit password and you can change the input method to input password value. Input password again to confirm. You can see the corresponding dialogue box if your two passwords input here are not the same. Please click **【ESC】** to return to modify and click **【ENTER】** button to save. See Figure 2-11.



Figure 2-11

### 2.3.3.2 Add Users

Please input user name (max 8-digit) and then set corresponding password. The group options include user/guest. See Figure 2-12,

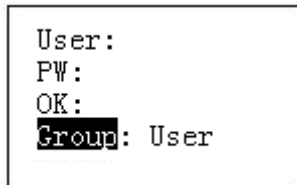

Figure 2-12

- Guest: The guest can only operate control point operation.
- User: The user has the PTZ control, system setup, backup, advanced setup and etc. Move the cursor to the corresponding item and then use the joystick to move the left/right to turn ○ to ● to enable this function. See Figure 2-13.



Figure 2-13

#### Note

The account setup here refers to the rights for the keyboard to control device. The keyboard can not control the device to operate specified function if it does not have the corresponding rights.

### 2.3.3.3 Delete Users

Select a user first and then click **【ENTER】** to remove.

### 2.3.3.4 Rights

It is to change user rights.

## 2.3.4 Config

#### Note

The configuration files import/export function is for KB1000 and KBD1000 series product only.



The configuration manager includes configuration files import/export, clear zones and factory default setup. See Figure 2-14.

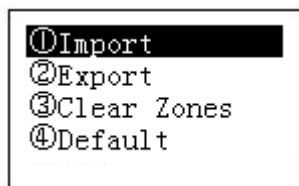

Figure 2-14

#### 2.3.4.1 Import

Insert the flash disk that contains the upgrade files to the keyboard and then go to the import interface. Click **【ENTER】** to import the configuration files.

#### 2.3.4.2 Export

Insert the flash disk to the keyboard and then go to the export interface. Click **【ENTER】** to export the configuration files.

#### 2.3.4.3 Clear Zones

Go to the clear zones interface and then click **【ENTER】** to clear all control points.

#### 2.3.4.4 Default

Go to the default interface and then click **【ENTER】** to restore keyboard configuration to factory default setup.

### 2.3.5 Version

It is for you to view current version information and etc. See Figure 2-15.

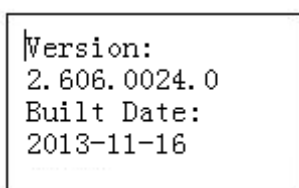

Figure 2-15

### 2.3.6 Model

It is for you to view current keyboard model. See Figure 2-16.

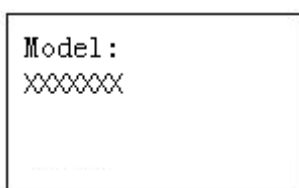

Figure 2-16

## 2.4 Zones

In this interface, you can quickly search a device via device ID, device name, COM address, IP and etc. Keyboard can automatically connect to the device and you can use the keyboard to control it. See Figure 2-17.

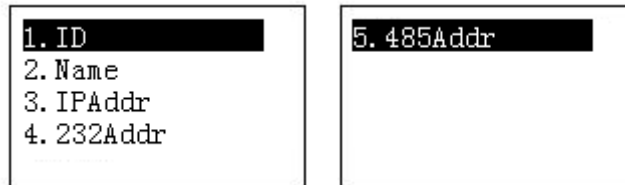

Figure 2-17

## 3 Keyboard Control DVR

### 3.1 Connection

#### 3.1.1 RS232 Serial Port Connection

You can use one RS232 cable to connect DVR serial port and keyboard serial port together. DVR address number ranges from 1 to 255, please refer to DVR user's manual for more information.

#### 3.1.2 Via RS485 Connection

You can use one RS232 port connects to one DVR only.

You need to use RS 485 port if you want to control several DVRs.

Connection

You can use one RS485 to RS232 switch box (provided) connect with DVR RS232 port. See Figure 3-1.

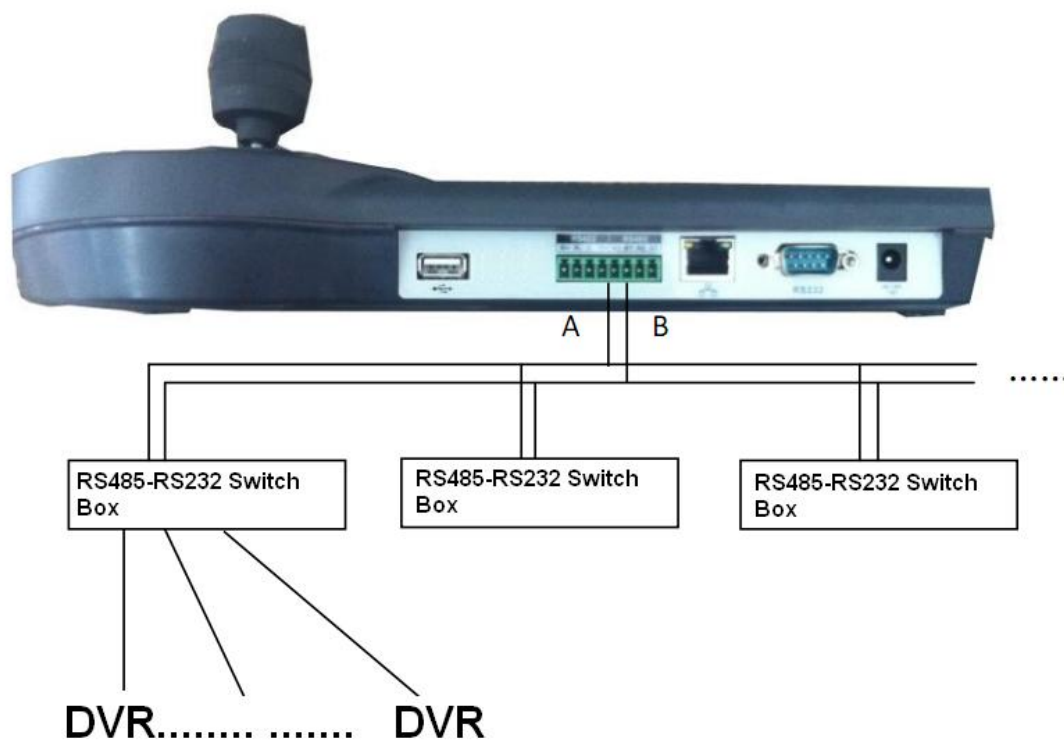

Figure 3-1

#### Note

One RS485 bus can connect with thirty-two RS485-RS232 switch boxes, one RS485-RS232 switch box can connect with twelve DVRs.

#### 3.1.3 Multi-keyboard link via RS485

You can use the following figure if you are connecting multiple keyboards via RS485 port. See Figure 3-2.

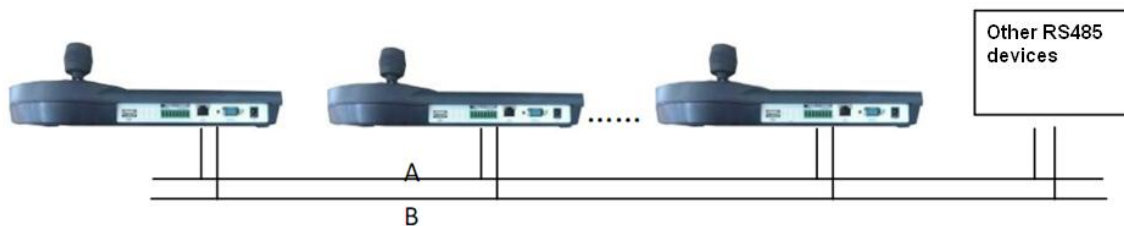

Figure 3-2

**Multi-converter connection:**

The last converter on RS 485 port must be short circuited. (E.g.: open converter). See Figure 3-3. See the image below, you need to change [1-2] short circuit to [2-3] short circuit.

**Note:**

Menu serial setup should conform to the device you connected; otherwise keyboard can not control the device!

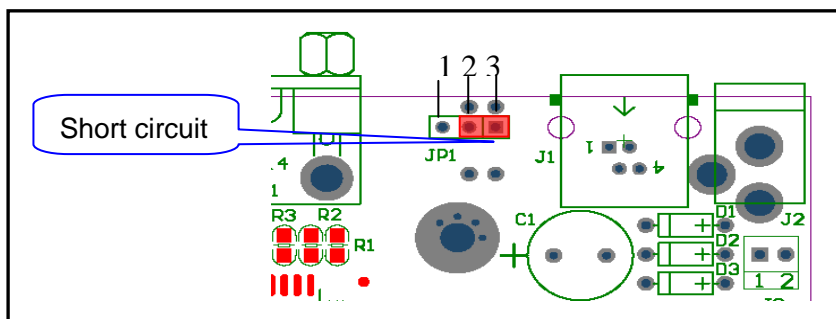

Figure 3-3

**3.2 Network Connection (For network keyboard only)**

Connect RJ45 port to the network to realize network control and upgrade.

**3.2.1 RJ45 port connection**

**3.2.1.1 Direct connection**

Please refer to Figure 3-4 for direct connection information.

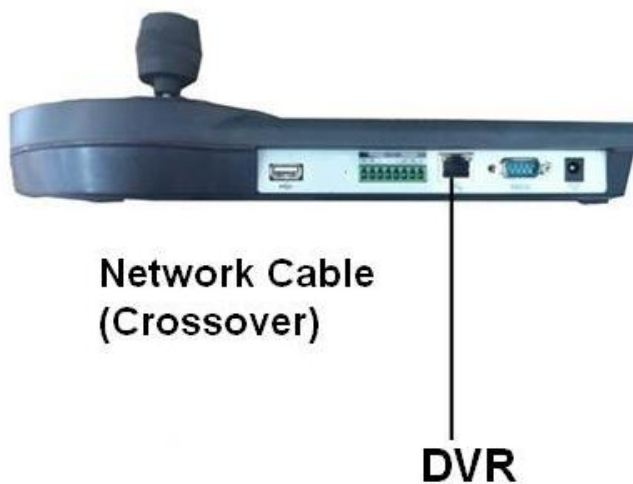

Figure 3-4

**3.2.1.2 Connect via HUB**

Please refer to the following figure if you are connecting via the hub. See Figure 3-5.

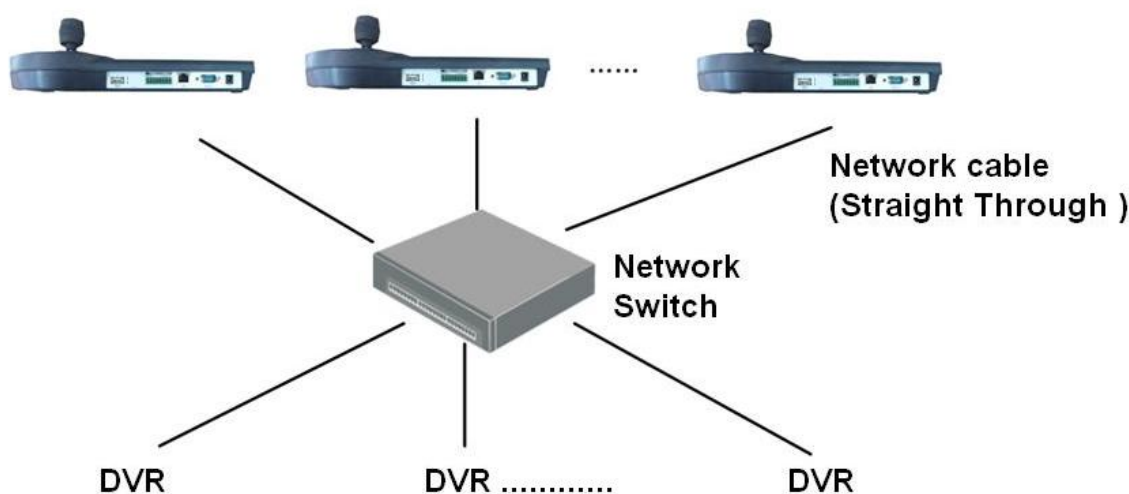

Figure 3-5

### 3.3 DVR and Keyboard Setup

#### 3.3.1 DVR Setup

- Before operation, please make sure cable connection is proper.
- In DVR menu, from Setting->RS232. The COM function is network keyboard and then set corresponding parameters.

The default setup is shown as below.

- Baud rate: 9600
- Data bit: 8
- Stop bit: 1
- Parity: none.

Please note keyboard setup should conform to DVR setup.

- Go to the zones interface of the keyboard. Please refer to chapter 2.3.2

#### Note

- RS232 address/RS485 address is the device No. of the DVR.
- The protocol usually is DH-2. It is the network keyboard and the 2<sup>nd</sup> control keyboard protocol. The DVR COM protocol is network keyboard protocol.

- After the setup, click **【ESC】** to exit control point control interface. System pops up a dialogue box you can click **【ENTER】** to save data or click **【ESC】** to cancel setup.

#### 3.3.2 Network Connection Setup

The network connection steps are similar to the COM setup. Please note, on the zones interface, the link type shall be NET.

Please input DVR IP address, the control point port is 37777. The protocol is the same as the COM setup.

## 3.4 Operation

### 3.4.1 Login



The DVR local user has the higher priority than the keyboard user. Before you login, please logout the DVR local menu user, otherwise, you can not use the keyboard to control the device.

You can select ID, device name, IP address, RS232, RS485 and etc to login.

- a) Click **【ENTER】** on the keyboard, you can go to the menu options interface.
- b) Select zones.
- c) Input ID, device name, IP address, RS232, RS485 you set on control point interface, Click **【ENTER】** to begin search.
  - System can automatically connect to the DVR if the search is successful.
  - System pops up a dialogue box to remind you such as the address does not exist, please input again. Please check the information and input again.

#### Tips

Click **【ID】** on the keyboard and then input ID number. Click **【ENTER】** to quickly find the device.

### 3.4.2 Logout

Click **【ID】** on the keyboard and then click **【ESC】** to exit.

### 3.4.3 Playback

Click **【PLAY】** on the keyboard, you can go to the DVR search interface. Use joystick to control the playback buttons such as stop, fast play, slow play and etc. Click **【ENTER】** to confirm. See Figure 3-6.

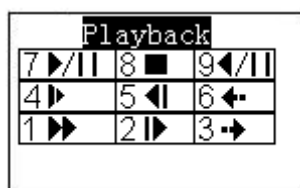

Figure 3-6

### 3.4.4 Record

On the keyboard, click **【AUX】** and **【1】** at the same time, you can go to DVR record control interface.

Use the joystick to set channel number and status. Click **【ENTER】** to save current setup.

### 3.4.5 PTZ Control and Video Color

On the keyboard, click **【FN】** and **【1】** at the same time, you can go to the DVR aux interface.

Use the joystick to select PTZ or video color set.

Click **【AUX】** and **【2】** button at the same time, you can directly go to the PTZ control interface.

### **3.4.6 Tour**

On the keyboard, click **【FN】** and **【2】** at the same time, you can control the tour function of the DVR.

#### **Note**

This function is only valid when the tour function of the DVR is enabled. You need to go to the Setting->Display to enable tour function.

### **3.4.7 1-Window/Multiple-Window Switch**

- On the keyboard, click a number and **【CAM】** at the same time, you can go to the specified channel. For example, click number **【1】** and **【CAM】** to go the channel 1.
- On the keyboard, click a number and **【MULT】** at the same time, you can enable multiple-channel display mode. For example, click number **【4】** and **【MULT】**, system goes to 4-window display mode.

## 4 Network Keyboard Control Speed Dome

### 4.1 Cable Connection

Please connect keyboard A/B line to speed dome A/B line connection is right.

### 4.2 Keyboard Setup

- Please make sure keyboard A/B line and speed dome A/B line connection is right.
- Set speed dome address so that the speed dome address and the keyboard RS485 address are the same.
- Go to the zones interface of the keyboard. Please refer to chapter 2.3.2

#### Note

Please select protocol according to the speed dome type. The default setup is DH-SD.

- After the setup, click **【ESC】** to exit control point control interface. System pops up a dialogue box you can click **【ENTER】** to save data or click **【ESC】** to cancel setup.

### 4.3 Operation

On the keyboard, click **【ID】** to go to the control point interface to set speed dome ID to connect to the speed dome.

After successful connection, the interface is shown as below. See Figure 4-1.

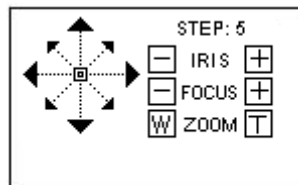

Figure 4-1

- Step: The move speed. Input number buttons on the keyboard and then click **【ENTER】** to confirm. The speed ranges from 1 to 8. The step 1 is faster than step 8.
- The lens movement supports 8 directions. It includes: up/down/left/right/top left/top right/bottom left/bottom right. Please use the joystick to control.

#### 4.3.1 Speed Dome Menu

On the keyboard, click **【OTHER】** button. The interface is shown as below. See Figure 4-2.

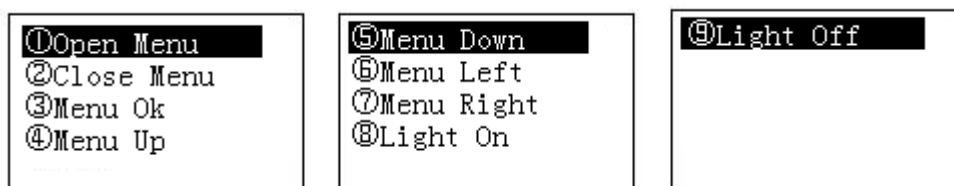

Figure 4-2



In this interface, you can use the joystick to control the menu interface of the preview interface of the speed dome WEB.

### 4.3.2 Iris/Zoom/Focus

#### 4.3.2.1 Iris

On the keyboard, click **【IRIS】** button, use button **【+】** and **【-】** or turn joystick up/down to control the iris.

#### 4.3.2.2 Focus

On the keyboard click **【FOCUS】** button, use button **【+】** and **【-】** or turn joystick left/right to control the focus.

#### 4.3.2.3 Zoom

On the keyboard click **【ZOOM】** button, use button **【+】** and **【-】** or turn joystick clockwise or counter clockwise to control the zoom.

### 4.3.3 Preset

On the keyboard click **【PRESET】** , the interface is shown as below. See Figure 4-3.

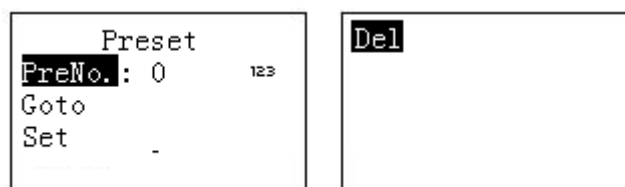

Figure 4-3

#### 4.3.3.1 Set Preset

- Use joystick to control PTZ to set preset position.
- On the keyboard click **【PRESET】** button, you can go to the preset interface.
- Input preset number and then select set preset, click **【ENTER】** to save preset setup.

#### 4.3.3.2 Go to preset

Select Preset and then input preset number, click **【ENTER】** to go to the corresponding preset position.

#### 4.3.3.3 Delete preset

Input the preset number at the preset No. item and then select Delete, click **【ENTER】** go remove it.

### 4.3.4 Scan

- On the keyboard click **【SCAN】** button, the interface is shown as below. See Figure 4-4.

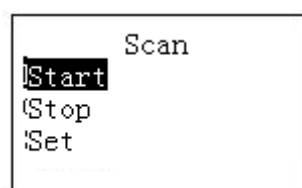

Figure 4-4

b) Select Set and then click **【ENTER】** , you can see an interface shown as in Figure 4-5.

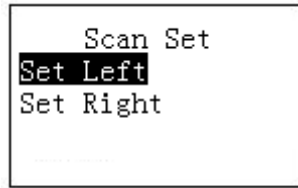

Figure 4-5

c) Select left limit and right limit, click **【ENTER】** to set.

d) Use joystick to control PTZ to set limit.

- Select start and then click **【ENTER】** ,system begins to scan according to the left/right limit you set.
- Select stop and then click **【ENTER】** , system stops scan.

### 4.3.5 Pan

On the keyboard click **【PAN】** button, the interface is shown as below. See Figure 4-6.

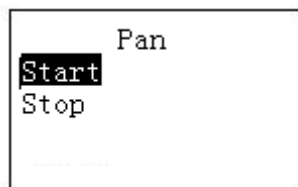

Figure 4-6

- Select start and then click **【ENTER】** button, system begins pan operation.
- Select stop and then click **【ENTER】** button, system stops pan operation.

### 4.3.6 Tour

#### 4.3.6.1 Set Tour

a) On the keyboard click **【TOUR】** button, the interface is shown as below. See Figure 4-7.



Figure 4-7

b) Select set item, the interface is shown as in Figure 2-9.

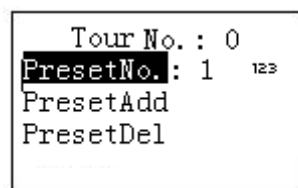

Figure 4-8

- c) Input a value at the tour No.
- d) Add preset to the tour.
  - Select preset No. and then input a preset number.
  - Select preset add and then click **【ENTER】** to confirm. Now the preset is added to the tour.

#### 4.3.6.2 Tour

Select tour and then input tour number.

- Select start and then click **【ENTER】** , system begins tour.
- Select stop and then click **【ENTER】** ,system stops tour.
- Select delete and then click **【ENTER】** , system removes the tour.

### 4.3.7 Pattern

#### 4.3.7.1 Pattern

- a) On the keyboard click **【PATTERN】** , the interface is shown as below. See Figure 4-9.

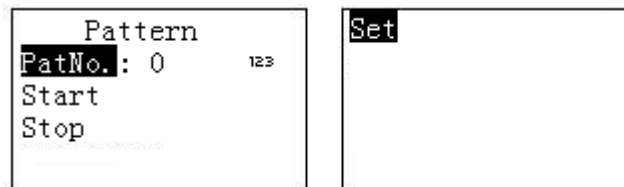

Figure 4-9

- b) Select tour number and then input a value.
- c) Select tour set button and then click **【ENTER】** button.
- d) Use joystick to set pattern and then click **【ENTER】** to end. The speed dome can memorize your whole operation.

#### 4.3.7.2 Start pattern

Select tour No. and then input a tour number, select start and then click **【ENTER】** button, system begins pattern operation.

#### 4.3.7.3 Stop pattern

Select tour No. and then input a tour number, select stop and then click **【ENTER】** button, system stops pattern operation.

## 5 Keyboard Control NVS

### 5.1 Connection

Connect the network cable to the RJ45 network port of the keyboard, now you can implement network control and upgrade.

### 5.2 Keyboard Setup

- a) On the keyboard to set control point setup, Please refer to chapter 2.3.2. The link type shall be NET.

#### Note

- Please input NVS IP address and the default port value is 37777.
  - The protocol usually is DH-2. It is the network keyboard and the 2<sup>nd</sup> control keyboard protocol. The DVR COM protocol is network keyboard protocol.
- b) After the setup, click **【ESC】** to exit.

### 5.3 Operation

#### 5.3.1 Login

- a) You can use ID, device name, or IP address to login the device.
- b) On the keyboard click **【ENTER】**, you can go to the menu option interface.
- c) Select control point.
- d) Input ID, device name, or IP address and then click **【ENTER】** to search.
  - System automatically connects to the NVS if the search is successful.
  - You can see the corresponding dialogue box such as the “IP address does not exist. Please input again!” Please check the information and input again.

#### Tips

On the keyboard click **【ID】** and then input ID, click **【ENTER】** button to quickly find ID and connect to the device you want to control.

#### 5.3.2 Exit

On the keyboard click **【ID】** and then click **【ESC】**, you can exit menu.

#### 5.3.3 1-Window/Multiple-Window Switch

- On the keyboard, click a number and **【AUX】** at the same time to select corresponding VGA port number. For example, click number **【1】** and **【AUX】** to go to video from the VGA 1.
- On the keyboard, click a number and **【CAM】** at the same time, you can go to the specified channel. For example, click number **【1】** and **【CAM】** to go the channel 1. Or you can click a number and **【SETUP】** to go to a channel. But the value here ranges from 1 to 9. That is to say, you can go to channel 1-channel 9 only.

- On the keyboard, click a number and **【MULT】** at the same time, you can enable multiple-channel display mode. For example, click number **【4】** and **【MULT】** ,system goes to 4-window display mode.

## 6 Keyboard Upgrade

### 6.1 Control Keyboard Upgrade

Control keyboard does not support remote upgrade. Please ship your control keyboard back to our factory to upgrade.

### 6.2 Network Keyboard Upgrade

Before upgrade, please make sure your network keyboard is well connected. You can use command "PING" to test network connection, the return value TTL should be less than 255. Please download upgrade file to your local PC. You can download upgrade file from our website or from our local service engineer.

Double click RECUUpgrade.exe to begin upgrade. See Figure 6-1.

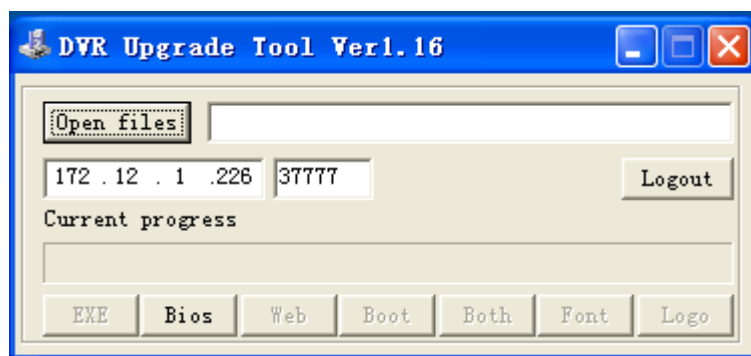

Figure 6-1

Please input network keyboard IP address and port. Then click open files button to select upgrade file.

After selection, click open to add current file to the address column.

System automatically recognizes upgrade file, you can click BIOS button to begin upgrade.

System pops up upgrade process bar for your reference.

After successful upgrade, click OK to finish operation.

#### **Tips:**

Use you mouse to click the upgrade file; drag it to the "open files" column and then release. You can see the file path and current file is open.

System pops up alert information if it is not keyboard upgrade file.

## 7 Make COM Cable

The keyboard standard accessories bag includes the following items:

- One DB9
- Seven DB9
- One six-pin crystal port
- One 25-pin (DB25)
- One 485 switch box. (Including one power sourcing.)

### 7.1 Make RS232 COM Cable

Please refer to the following figure for RS232 port information. See Figure 7-1.

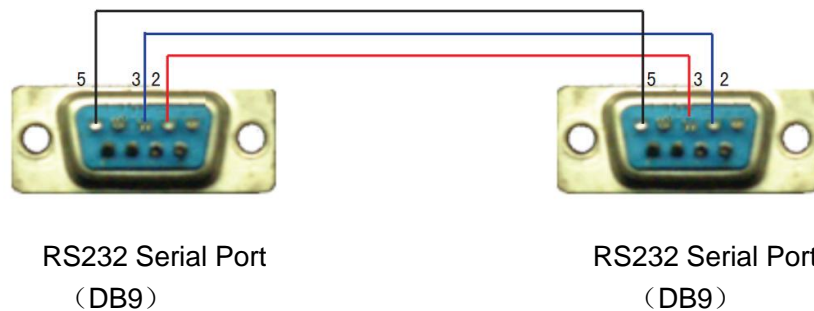

Figure 7-1

### 7.2 Make RS485 COM Cable

You can refer to Figure 7-2 if you are connecting the keyboard with the switcher box.

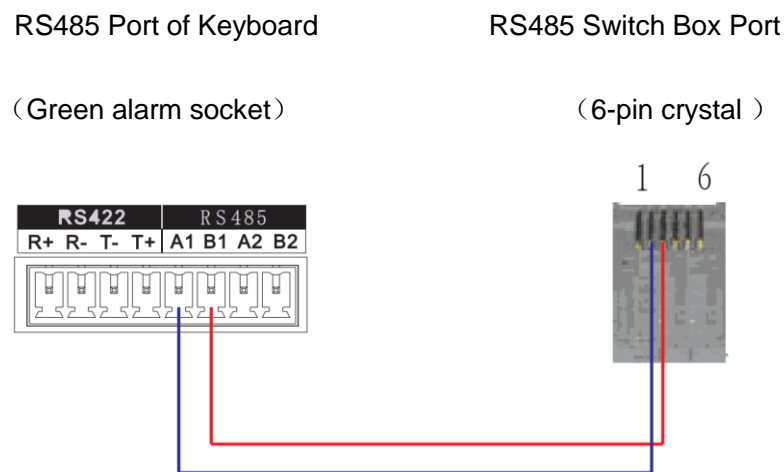

Figure 7-2

### 7.3 25-pin Port and Switch Box Connection

Connect switch 25-pin box RS232 port with DVR RS232 port. (25-pin outlet supports maximum twelve RS232 ports. Switch is just for sending not for receiving. So you can use two cables: GND and TXD)

Please refer to the following sheet if you are connecting 485 switch box to DVR See Figure 7-3.

RS485 Switch Box 25-Pin Port  
(DB25)

RS232 Port  
(DB9)

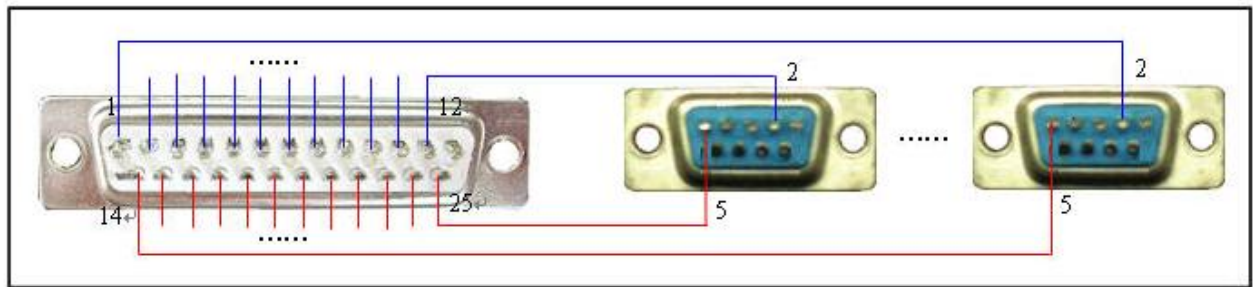

Figure 7-3

**Note:** you can use standard RS232 port to connect keyboard with DVR.

**Note:**

- This manual is for reference only. Slight difference may be found in the user interface.
- All the designs and software here are subject to change without prior written notice.
- If there is any uncertainty or controversy, please refer to the final explanation of us.
- Please visit our website for more information.