



## Natron WE-C

*Conventional fire alarm wireless  
expander (network gateway) module*

**TELETEK**

**Teletek Electronics JSC**  
Address: 2 Iliyansko Shose Str,  
1220 Sofia, Bulgaria

**CE** 23  
2918

DoP No: 229

EN 54-18:2005  
EN 54-18:2005/AC:2007  
EN 54-25:2008

**ATTENTION: Read carefully this installation Instructions before installing the device!  
This manual is subject to change without notice!**

### 1. General Description

Natron WE-C is a wireless expander (network gateway) module designed for operation with conventional fire alarm panels, including MAG series panel, produced by Teletek Electronics JSC. Natron WE-C is powered from external power supply with back-up battery. The module is equipped with special inputs for monitoring the main and back-up power supplies.

Natron WE-C communicates with Natron series wireless devices enrolled to its configuration. Up to 32 wireless devices can be enrolled to a specific expander (network gateway) module, forming a linear network. Up to 5 Natron WE-C modules can be connected to a single conventional fire alarm control panel as this depends on the system/panel capacity.

Natron WE-C is mounted in a compact plastic enclosure box suitable for wall mounting. The information of the status of the enrolled wireless devices is presented on a LCD text display. The programming of the wireless devices parameters is from the module menus.

A dipole SMA type antenna is supplied with the expander (network gateway) module to ensure wide covering range and stable communication with the enrolled wireless devices.

### 2. Functional Features

- Specially designed for extending the application of conventional fire alarm panels
- Direct connection to conventional zone terminal
- Compatible for operation with MAG series and third-party conventional fire alarm control panels
- Up to 5 wireless expanders (network gateway) modules to conventional panel/building\*
- Up to 32\*\* NATRON series wireless devices enrolled to a single Natron WE-C module
- Dipole antenna, SMA connector type
- Event messages for wireless device status: low battery, tamper, lost device
- Menu for reviewing the signal strength of the enrolled devices
- LCD display, dot matrix 16x2
- Multilanguage menus
- Standards applied: EN 54-18; EN 54-25

\* The number depends on the type of the conventional panel and the capacity of the system.

\*\* The number of enrolled NATRON devices depends on the number of the current connected wired devices to the conventional zone. Up to 32 wired and wireless detectors can be connected to a conventional zone.

### 3. Technical Specifications

Power supply (External power supply unit, EN 54 compatible)	24 VDC ± 10%
Consumption: - Nominal consumption, LCD display ON - Nominal consumption, LCD display OFF - Max. consumption, LCD display ON - Max. consumption, LCD display OFF	17mA@24V DC 14mA@24V DC 19mA@20V DC 15mA@20V DC
Radio frequency	868MHz
Communication type	Bidirectional
Communication protocol	NATRON TTE
Radio signal modulation type	GFSK
Number of frequency channels	6 pair channels
Radiated power	≤ 25 mW
Receiver category (EN300-220-1)	1.5
Max. connected wireless modules to a conventional panel*	Up to 5
Max. enrolled wireless devices to a wireless module	32
Communication range with Natron wireless devices (open space**)	1500m
Trace attenuation	> -90dBm
Antenna: - Type - Frequency - Impedance - Type of Radiation - Gain - Connector type - Dimensions	Dipole antenna 866-870MHz, Center 868Mhz 50Ω Omni-directional 2 dBi SMA Male (Swivel) 242x12.5mm
Operation temperature	-10°C to +55°C
Related humidity resistance (no condensation)	(93±3)%@ 40°C
Enclosure box: - Material - Dimensions - Color - Protection - Weight (with mounted PCB and antenna)	ABS 191x125x60mm RAL 7024 (graphite grey) IP66/68 ~ 200g

\* Depends on system/control panel capacity

\*\* Depends on system/control panel capacity and building structure

### 4. Installation Place and Mounting

It is strongly recommended to design the Natron wireless system in advance on paper, before starting the installation. Natron WE-C expander (network gateway) module should be installed at 2-2.5m above the floor level.

**Attention: Avoid installation of Natron WE-C module and the wireless devices near to:**

- Power lines or other high voltage equipment with large electric consumption.
- Big metal structures – cabinets, pending ceilings, thick concrete walls. Note that, the quality of the signal strength is reduced with 80%, and sometimes with 100% (full reflection) in premises with metal walls or surfaces.
- Fluorescent lamps and lighting fixtures.
- Wi/Fi Routers, wireless telephone stations, computers and network cabling.

### General View and Dimensions

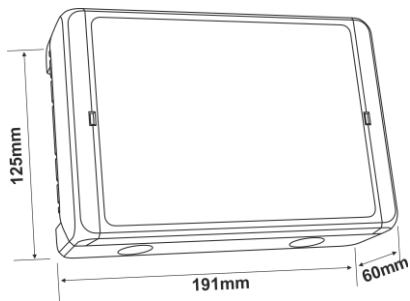

### Opening the enclosure box

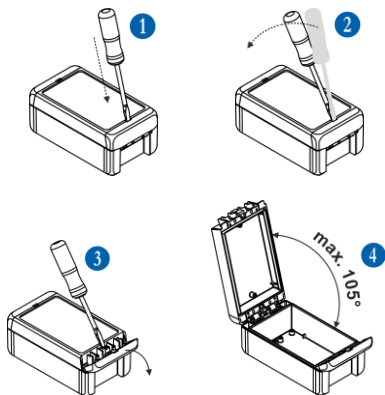

### Mounting holes

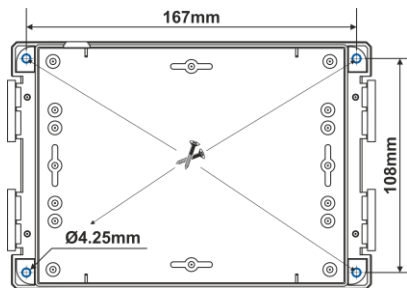

Use fixing elements according the mounting surface

### Positioning of the antenna

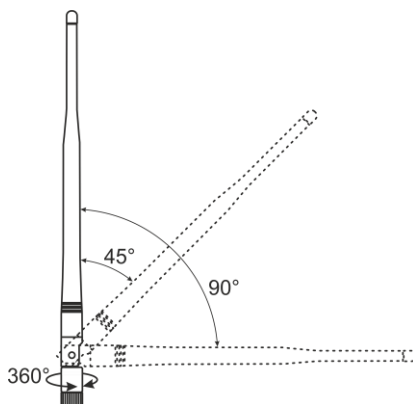

**For achieving the best signal strength and coverage it is recommended the antenna to be mounted in straight up position!**

### Openings for running cables



There are two openings for running cables Ø20mm at the box bottom.

The SMA antenna is mounted to the module PCB after installation of the box. The position of the antenna can be adjusted according the mounting place. The antenna's body can be bent at position of 45° and 90° and is providing continuous rotation on 360° at its base.

### Closing the enclosure box

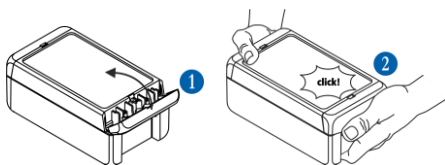

## 5. System Topology

The Natron WE-C wireless expander (network gateway) module must be powered from an external 24V DC power supply unit, compliant to EN 54 standard. The module is connected to zone and sounder circuits of the conventional fire alarm panel. The enrolled to the module Natron series devices, operate in linear network.

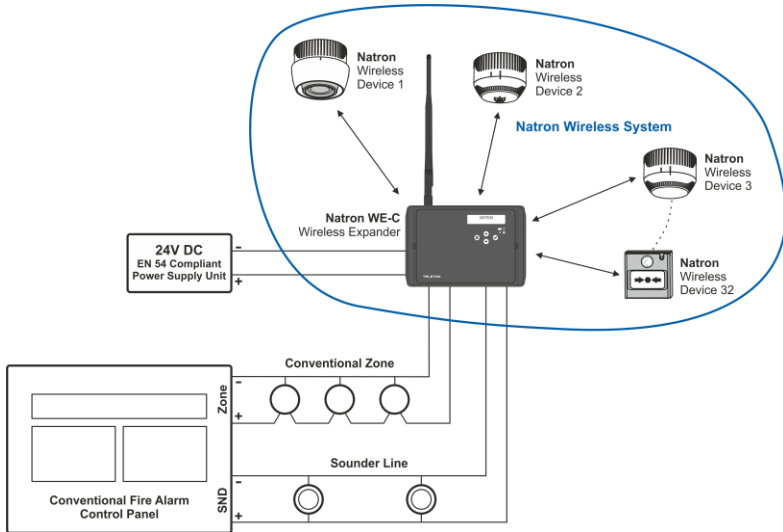

Up to 5 separate Natron WE-C modules can be connected to single conventional panel. The number of connected wireless modules depends on the system/panel capacity. For optimum operation, plan to ensure at least 2m distance between two modules and the same minimal distance between each device and a single module.

**Note:** In case of connection of 5 wireless modules to a fire alarm panel, they must be set for operation at different frequency channel numbers to avoid delay in operation – see item 16.

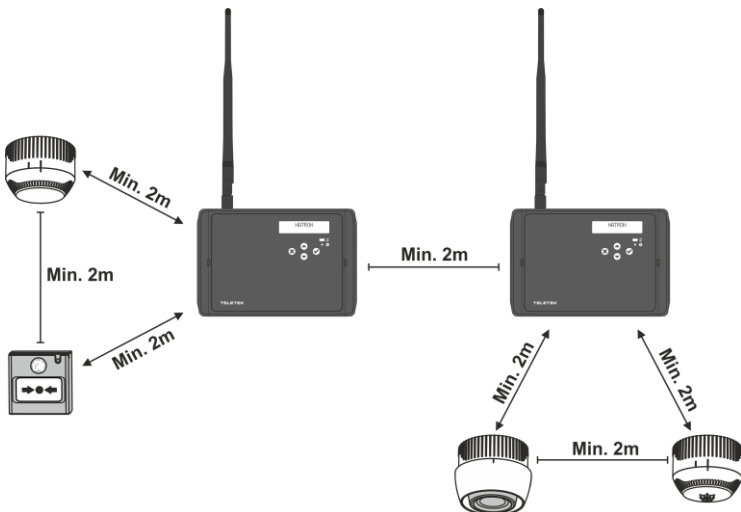

## 6. PCB Elements

To access the PCB of the module, open the enclosure box (follow the steps described in item 4). The PCB is factory mounted at the back side of the front cover.

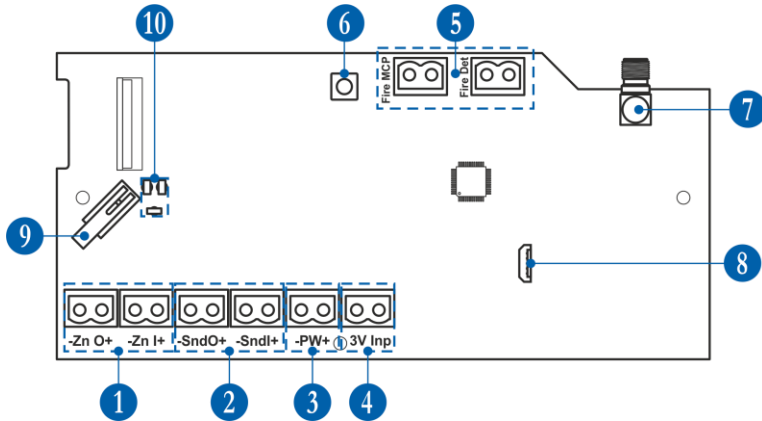

- 1 - Terminals for connecting the conventional zone line - item 7.2.
- 2 - Terminals for connecting the sounders' circuit - item 7.3.
- 3 - Terminals for connecting the power supply unit - item 7.1.
- 4 - Terminals for monitoring the power supply - item 7.1.
- 5 - Terminals for connecting EOLs for zone alarm - item 7.4.
- 6 - Button for entering the menus for programming and settings.
- 7 - Antenna connector.
- 8 - Micro USB for reading the configuration with ProsTE software.
- 9 - Tamper button for self-protection of the module's box.
- 10 - LED indicators – see the detailed description in item 8.

## 7. Wiring the Electrical Circuits

**Attention: All wiring connections between wireless expander (network gateway) module and conventional fire alarm panel must be done with switched off main and back-up power supply units of both devices!**

The module is equipped with 2-position plug terminals for easy wiring of all electrical circuits. To make a connection, just pick up the plug to dismount it from the PCB terminal. Make the wiring observing the polarity according the connection diagrams presented further in this installation manual. Then mount back the 2-position plug to the PCB terminal.

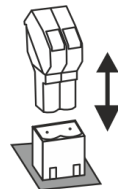

## 7.1 Power Supply Unit

Natron WE-C is powered only from an external power supply unit 24V DC. The power supply terminals are connected to  $\pm$ PW terminals of Natron WE-C as observing the polarity.

Natron WE-C is equipped with a special input "Inp" for Fault monitoring of the external power supply unit. This option can be used when the external power supply unit has a special Fault output for monitoring. According to the type of the Fault output (open collector or energized) of the external power supply unit, there are two types of connection diagrams for monitoring.

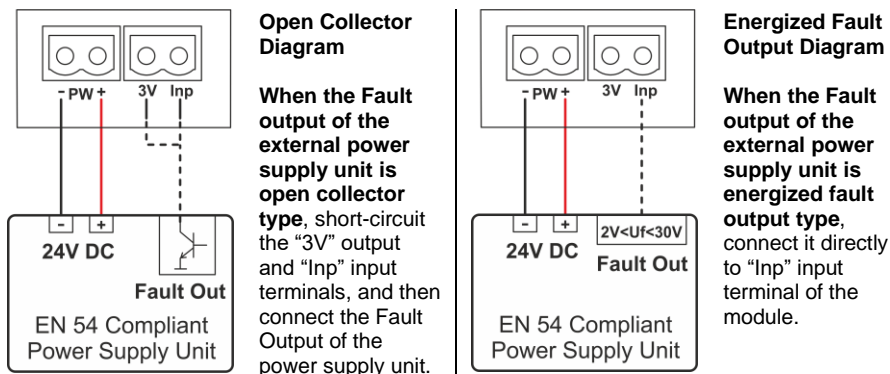

In case of power supply fault event, the conventional control panel will indicate FAULT in the zone line to which the Natron WE-C is connected.

## 7.2 Conventional Zone Line



**ATTENTION: Natron WE-C wireless module MUST BE POSITIONED ALWAYS AT THE END of the conventional zone line!**

It is not allowed to connect the module at the begging or in the middle of the zone line, because that will disturb the correct operation of the fire alarm system and is not in compliance with the requirement of EN 54!

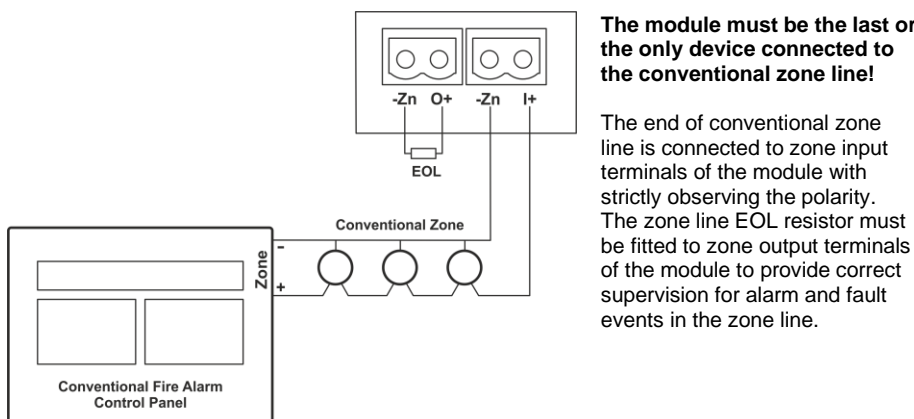

### 7.3 Sounders Circuit



**ATTENTION: Natron WE-C wireless module MUST BE POSITIONED ALWAYS AT THE END of the sounders circuit – the module must be the last device connected to the line!**

It is not allowed to connect the module at the beginning or in the middle of the sounders circuit, because that will disturb the correct operation of the fire alarm system and is not in compliance with the requirement of EN 54!

The module must be the last or the only device connected to the sounders circuit!

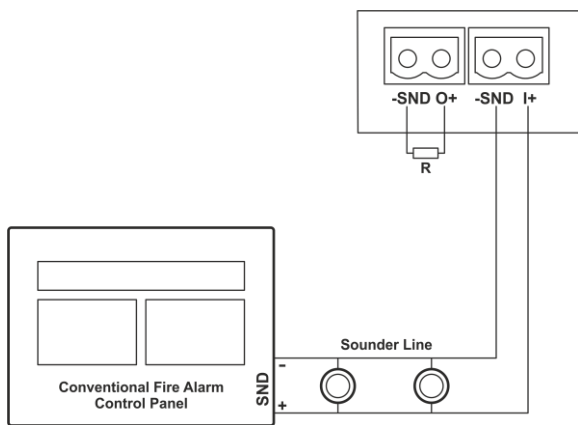

The end of sounder line is connected to sounder input terminals of the module with strictly observing the polarity. The sounder output terminals of the module must be terminated with resistor (R\*) to provide correct supervision for the alarm and fault events in the sounders' line circuit.

**\*Note:** 10k resistor is required when the module is connected to conventional MAG series fire alarm panels. When the module is connected to third-party conventional fire alarm panel, is possible the resistor value to be different – check this in the fire panel technical manual.

### 7.4 Zone Alarm EOL Resistors

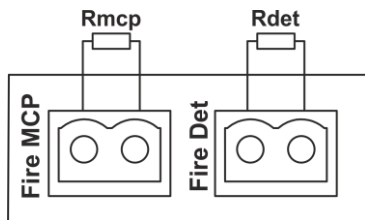

The zone alarm EOL resistors must be always installed at "Fire MCP" and "Fire Dev" terminals at Natron WE-C module.

The value of the resistors is calculated according the operation voltage of the conventional zone and the fire alarm threshold current of the used manual call points and fire alarm detectors.

Note that, some conventional fire alarm panels are able to distinguish the activation of manual call points and fire alarm detectors, and other not.

Calculate the zone alarm resistor values using the formulas:

$$R_{mcp} = U_{zone} / I_{MCP \text{ fire}}$$

$$R_{det} = U_{zone} / I_{Detector \text{ fire}}$$

Refer to documentation of the used conventional fire alarm control panel and used conventional detectors for supported features, technical data and electrical values.

---

## 8. Front Panel

At the front panel of Natron WE-C, are located LCD text display and operation buttons.

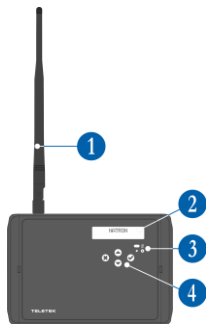



1 – Antenna (mounted to the antenna connector on the PCB).

2 – LCD text display, dot matrix 16x2.

3 – LED indication for the module status:

Symbol	LED	State	Description
	green	Lighting on	Programming mode entry.

4 – Operation buttons:

Button	Function	Description
	ENTER	Enter in selected programming menu. Confirmation of operation or introduced settings.
	CANCEL	Exit from programming menu. Reject the operation or introduced settings.
	UP/DOWN	Button for scrolling up/down the programming menus or available settings.

## 9. Initial Power-up of Natron WE-C

1. Switch off the main and back-up power supply of the conventional fire alarm panel.
2. Open the enclosure box of the expander (network gateway) module and mount it on the place of installation – see item 4.
3. Connect Natron WE-C module at the end of the conventional zone line and at the end of sounders circuit – see item 7.
4. Connect the external power supply unit to “±PW” terminals of the module.
5. Switch on the main and back-up power supply of the conventional panel.
6. Switch on the external power supply unit of Natron WE-C.
7. Mount the antenna and enroll wireless devices to Natron WE-C expander (network gateway) module – see item 11.
8. Program the wireless devices parameters according the requirement of the fire installation – see item 14.
8. Close the enclosure box of the module. Set the position of the antenna for best signal strength and coverage – see item 4.
10. Check the signal strength of every wireless device and test its operation in case of fire alarm condition – see item 15.
11. Reset the conventional fire alarm panel after the adding and testing of wireless devices is complete.



---

## 10. Access and Organization of Programming Menus

The access to programming mode and setup menus of Natron WE-C wireless expander (network gateway) module is limited for support engineers and maintenance technicians only.

At normal operation mode, the screen of Natron WE-C is switched off. Pressing any of the operation buttons will activate the screen, as according the current state of the module, NATRON text or fault/warning message will appear. To enter in programming mode, you have to open the enclosure box and single press the programming button on the control module's PCB – see item 6, position 6.

The scrolling between available menus is realized with UP/DOWN operation buttons. The confirmation of set parameters is with ENTER button and rejecting and exit from current menu – with CANCEL button – see item 8, position 4.

The SETUP MENU includes the following main menus for operation and settings:

No	Menu	Short description	See details
1	ADD DEVICE	Enrolling wireless devices to module's configuration.	Item 11
2	REMOVE DEVICE	Deleting wireless devices from module's configuration.	Item 12
3	FIND DEVICE	Finding location and operation test of wireless devices.	Item 13
4	DEVICE SETUP	Setting parameters for enrolled wireless devices.	Item 14
5	DEVICE RSSI	Checking the signal strength between the module and a selected device.	Item 15
6	CHANNEL SETUP	Setting a frequency channel number.	Item 16
7	LANGUAGE	Set the language of the menus.	Item 17

The exit of the setup menus can be done at any time with pressing the programming button on the control PCB - see item 6, position 6. The exit is also automatic after 2 minutes if there is no activity with the module (pressed operation button).

## 11. Enrolling of Wireless Devices

Natron WE-C wireless expander (network gateway) module supports operation with Natron series wireless devices. The enrolment algorithm is common for all devices.

1. Prepare the device for enrolment. Remove the mounting base to access the PCB with the batteries compartment. The batteries of all new devices are protected from activation with a folio strip.

**Note:** *If the device is not new, you have to reset it before enrolment to the module. To reset a device, power it on with the batteries and after that press and hold ENROLL button for 5-7 seconds. The reset is complete when the LEDs of the device flash 3 times in green, followed from 1 long flash in red and 1 long flash in green.*

2. Enter in programming mode of the module. Select menu 1. ADD DEVICE and press ENTER button. A list with already enrolled devices is shown on the screen with an order number and type of the device: SD (optical-smoke detector), TD (heat detector), MD (combined detector), MCP (manual call point), WSS (sounder with strobe), MIO (input-output module) – you can find detailed information about the wireless devices in their installation manuals.

3. Scroll down to find a free address to enroll the device. The free address is labeled as EMPTY.

4. Press ENTER button. Message SEARCHING >>> (arrows are blinking) appears on the screen showing that the module is scanning for signals from wireless device in its covering range.

**Note:** *If there is no signal from the device in 2-minute period, the module will exit automatically the programming mode.*

5. Power on the wireless device. If the device is new just remove the protective folio from the batteries – the enrolling process starts automatically. If the device is powered and reset - single press the ENROLL button. The LEDs of the device start flashing in red.

- 
6. In case of successful enrolment, the LEDs of the device flash 3 times in green, the message DONE appears on the screen and then the module automatically moves to the next free address in the list. The enrolled wireless device is added to the list with its specific type.
  7. Test the signal strength between the wireless device and the wireless module. Single press the ENROLL button of the device and wait for the LED indication:
    - 3 flashes in green – excellent signal strength;
    - 3 flashes in orange – good signal strength; but, if possible, change the place of installation;
    - 3 flashes in red – poor signal strength; it is obligatory to change the place of installation.You can also check the signal quality for the device in 5. DEVICE RSSI menu – see item 15.
  8. If the signal quality and strength are excellent or good, mount the device at installation place\*.
- \* Refer to the installation manual of the device for detailed information.

## 12. Deleting of Wireless Devices

The enrolled wireless devices can be completely removed from the module's configuration. The procedure of removing is common for all devices.

1. Enter in programming mode of the module. Scroll to menu 2. REMOVE DEVICE and press ENTER button. A list with present enrolled devices is shown on the screen with an order number and type of the device.
2. Find in the list the device which you want to remove. (**Note:** You can check if this is the exact device for removing as first perform finding device procedure – see item 13.)
3. Press ENTER button. Message “Are you sure?” will appear on the screen.
4. Confirm the removing with ENTER button. Or reject the action with CANCEL button.
5. In case of successful removing, the message DONE appears on the screen and then the module automatically moves to the first number in the list, regardless there is enrolled device to it or not.
6. Press CANCEL button to exit the menu for removing devices.

## 13. Finding of Wireless Devices

This is a procedure that helps the engineer to find the exact location of every wireless device in the fire installation and test the connection with module. The Natron series wireless fire alarm detectors are equipped with built-in buzzed for additional audio signalization in accompanying the visual LED indication. The procedure of finding is common for all devices.

1. Enter in programming mode of the module. Scroll to menu 3. FIND DEVICE and press ENTER button. A list with present enrolled devices is shown on the screen with an order number and type of the device.
2. Find in the list the device which you want to locate in the fire installation.
3. Press ENTER button. Message FINDING >>> (arrows are blinking) appears on the screen showing that the module is scanning for signals from the selected wireless device. The message will change for a while to FINDING DONE in case of success.

4. The device will respond with activated indication and signalization depending on its type:

Device	Type	Signalization	Action
TD	Heat detector	LEDs + Sound	LEDs are flashing in orange accompanied with short sound signals.
SD	Optical-smoke detector		
MD	Combined detector		
WSS	Sounder with strobe		LEDs are flashing accompanied with short sound signals.
MCP	Manual call point	LED	The status LED is flashing in red.
MCP-DE	Manual call point		
MIO	Input-output module		

5. The module will exit automatically the finding procedure after 70-80 seconds. You can also stop the procedure at any time with pressing CANCEL button.

6. Press CANCEL button again to exit from the menu for finding devices.

## 14. Settings parameters of wireless devices

In 4. DEVICE SETUP menu the installer can set some parameters of the devices and also to perform Enabling/Disabling of their operation.

Enter in programming mode of the module. Scroll to menu 4. DEVICE SETUP and press ENTER button. A list with present enrolled devices is shown on the screen with an order number and type of the device. Scroll to a device and press ENTER button to access the settings.

The following table presents the available settings according the device type.

Setup Menu	MCP	SD	TD	MD	WSS
ENABLE/DISABLE	✓	✓	✓	✓	✓
BUZZER		✓	✓	✓	
TONE					✓
VOLUME					✓
MODE					✓

### 14.1 Menu for Enable/Disable of Device

In the menu the installer can perform Enabling/Disabling of the operation of a device. The disabled devices do not send information about their status to the expander (network gateway) module. The disabled devices will not react on alarm events. The menu is available for all Natron series wireless devices.

To perform enabling/disabling, from the main menu scroll to 4. DEVICE SETUP and select a device number with the arrow buttons. Press ENTER. Select menu 1. ENABLE/DISABLE and press ENTER button. There are two setting, as the currently set is displayed on the screen. The setting is changed with pressing up/down arrow buttons.

- ENABLED – set by default. The device will report its current status to the module and will react on alarm events. Its operation is enabled.

- DISABLED. The device will not report its current status or alarm events to the module. Its operation is disabled.

Confirm the setting with ENTER button – the exit of the menu is automatic.

**ATTENTION: The disabling of sounders is not according the requirement of EN 54-2!**

## 14.2 Menu for Enable/Disable of Buzzer

In the menu the installer can perform Enabling/Disabling of the operation of the built-in buzzer in Natron fire alarm detectors – TD, SD and MD. The buzzer is used for finding the physical place of installation of a detector, and is activated in case of fire alarm event together with the other sounders in the system.

**Attention! The setting of this menu does not affect on the signalization in finding device procedure.**

To perform enabling/disabling of the buzzer, from the main menu scroll to 4. DEVICE SETUP and select a detector number with the arrow buttons. Press ENTER. Select menu 2. BUZZER and press ENTER button. There two setting, as the currently set is displayed on the screen. The setting is changed with pressing up/down arrow buttons.

- DISABLED – set by default. The built-in buzzer is disabled and will stay silent in case of fire alarm event in the system.















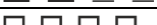

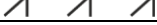
- ENABLED. The built-in buzzer is enabled and will sound in case of fire alarm event in the system. **Note:** When the operation of the built-in buzzer is enabled, the battery life of the fire detectors will be shorter - ~6 years.

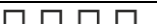
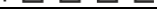
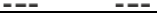





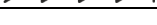

Confirm the setting with ENTER button – the exit of the menu is automatic.

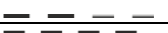
## 14.3 Menu for Setting the Tone Type

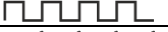
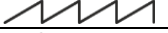
The menu is available only for Natron sounders. In the menu the installer sets the tone type of the sounder (1-32). The main tone type is 27.

To set the tone type, from the main menu scroll to 4. DEVICE SETUP and select a sounder number with the arrow buttons. Press ENTER. Select menu 2. TONE and press ENTER button. Use the up/down arrow buttons to select a number, according the table:

Tone	Tone Type	Tone Description/Application
1		970Hz
2		800Hz/970Hz @ 2Hz
3		800Hz - 970Hz @ 1Hz
4		970Hz 1s OFF/1s ON
5		970Hz, 0.5s/ 630Hz, 0.5s
6		554Hz, 0.1s/ 440Hz, 0.4s (AFNOR NF S 32 001)
7		500 - 1200Hz, 3.5s/ 0.5s OFF (NEN 2575:2000)
8		420Hz 0.625s ON/0.625s OFF (Australia AS1670 Alert tone)
9		500 - 1200Hz, 0.5s/ 0.5s OFF x 3/1.5s OFF (AS1670 Evacuation)
10		550Hz/440Hz @ 0.5Hz
11		970Hz, 0.5s ON/0.5s OFF x 3/ 1.5s OFF (ISO 8201)
12		2850Hz, 0.5s ON/0.5s OFF x 3/1.5s OFF (ISO 8201)
13		1200Hz - 500Hz @ 1Hz (DIN 33 404)
14		400Hz
15		550Hz, 0.7s/1000Hz, 0.33s
16		1500Hz - 2700Hz @ 3Hz
17		750Hz
18		2400Hz
19		660Hz
20		660Hz 1.8s ON/1.8s OFF

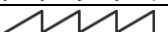
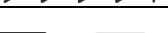
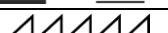
21		660Hz 0.15s ON/0.15s OFF
22		510Hz, 0.25s/ 610Hz, 0.25s
23		800/1000Hz 0.5s each (1Hz)
24		250Hz - 1200Hz @ 12Hz
25		500Hz - 1200Hz @ 0.33Hz
26		2400Hz - 2900Hz @ 9Hz
27		<b>2400Hz - 2900Hz @ 3Hz; 2500Hz (main sound frequency)</b>
28		800Hz - 970Hz @ 100Hz
29		800Hz - 970Hz @ 9Hz
30		800Hz - 970Hz @ 3Hz
31		800Hz, 0.25s ON/1s OFF
32		600Hz – 1100Hz, 2.6s/0.4s OFF

Confirm the setting with ENTER button – the exit of the menu is automatic.

#### 14.4 Menu for Setting the Tone Volume

The menu is available only for Natron sounders. In the menu the installer sets the tone volume of the sounder.

To set the tone volume, from the main menu scroll to 4. DEVICE SETUP and select a sounder number with the arrow buttons. Press ENTER. Select menu 3. VOLUME and press ENTER button. There two setting, as the currently set is displayed on the screen. The setting is changed with pressing up/down arrow buttons:

- HIGH – set by default.
- LOW.

Confirm the setting with ENTER button – the exit of the menu is automatic.

#### 14.5 Menu for Setting the Mode of Sounder

The menu is available only for sounders. In the menu the installer sets the mode of operation.

**Attention! The setting of this menu does not affect on the signalization in finding device procedure.**

To set the mode of operation, from the main menu scroll to 4. DEVICE SETUP and select a sounder number with the arrow buttons. Press ENTER. Select menu 4. MODE and press ENTER button. The currently set operation mode is displayed on the screen. The setting is changed with pressing up/down arrow buttons:

- SOUND+STROBE – set by default. Both the strobe light and sound are active in case of fire alarm event.
- SOUND. Only the sound is active in case of fire alarm event.
- STROBE. Only the strobe is active in case of fire alarm event.
- DISABLED.

Confirm the setting with ENTER button – the exit of the menu is automatic.

---

## 15. Checking the Signal Quality (RSSI)

This is a menu for checking the RF signal quality between wireless devices and expander (network gateway) module. The signal quality is assessed in [dB] as it can be measured and displaced for every of the devices. The procedure of checking RSSI is common for all devices.

1. Enter in programming mode of the module. Scroll to menu 5. DEVICE RSSI and press ENTER button. A list with present enrolled devices is shown on the screen with an order number and type of the device.
2. Find in the list the device for which you want to check the current RSSI.
3. Press ENTER button. The RSSI signal quality for the device is displayed. Refer to the table below:

Signal quality	Level RSSI	Description
< -90 dB	Loss	Bad signal or no connection.
-90 ÷ -70 dB	Good	The signal is satisfactory but needs improvement. It is recommended to change the installation place of the device.
> -70 dB	Excellent	Excellent signal.

5. You can exit the menu at any time with pressing CANCEL button.
6. Press CANCEL button again to exit from the menu for checking the signal quality.

## 16. Channel Setup

Natron series wireless devices communicate with the expander (network gateway) module via 6 different frequency pair channels. The installer can set operation via specific channel pair from 1 to 6, or to set automatic choice of the frequency channel. Basically, the installer can assess which channel has the lowest noise and interference level and to set the wireless system to operate on that exact channel.

To set a frequency channel, enter in programming mode and scroll to menu 6. CHANNEL SETUP. Press ENTER button. Set a number of pair channels using the arrow buttons, or set AFA (Automatic Frequency Agility) option for automatic choice of the frequency channel. The current displayed setting on the screen will be saved when you exit the menu with CANCEL button.

**Note:** When in a fire alarm system are connected the maximum number – 5 pcs - of wireless modules, they must be set for operation at different frequency channel numbers to avoid delay in operation.

## 17. Setting the Language

The menus of Natron WE-C expander (network gateway) module are available in different languages. To change the language of the menus, enter programming mode and scroll to 7. LANGUAGE menu. Press ENTER button. Use the arrow buttons to review the languages. The currently displayed language will be automatically set when you exit the menu with CANCEL button.

## 18. Events Reviewing Mode

Natron WE-C wireless expander (network gateway) module informs the users about different type of events concerning the current state of wireless devices enrolled to its configuration.

To review the active messages for events, the user has to press a random button on the front panel. The messages can be reviewed with arrow buttons, as the fire alarm and fault messages are with higher priority and are shown first, regardless their current number in the list.

The meaning of the displayed messages is as follows:

Message	Type	Description
Fire Alarm	Alarm	The message is with the highest priority and is displayed in case if fire alarm event – activation of wireless fire detector or call point.
Device Lost	Fault	There is no communication between the expander (network gateway) module and a wireless device. The possible reasons might be: no power supply of the device (absence or discharged batteries), signal lost or jamming.
High Dust	Fault	The smoke chamber of a fire detector is dirty and must be cleaned immediately.
Chamber Fault	Fault	There is a problem with the smoke chamber of a wireless device.
Tamper	Warning	Open tamper switch of a wireless detector or sounder – the device has been removed from its base.
Low Battery	Warning	The level of the power batteries is low. The batteries must be changed in one month time period after this message is displayed.

The message for the event is displayed always on the first row and on the second is displayed the order number of the device in the module's configuration and its type:

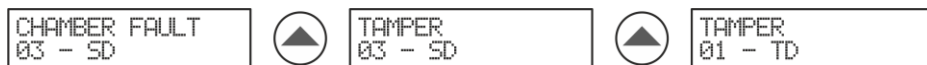

In the example above, after pressing a random button at the front panel, the fault message is displayed at first place, because of its higher priority. Use the arrows to review if there are other messages with lower priority.

The exit from the events' reviewing mode is automatic after 2 minutes, if there is no button pressed or other operation.

If currently there are no events, after pressing a random button, only NATRON text is displayed on the screen.

# 19. General Connection Diagram of Natron WE-C

