

**TECHNICAL AND
OPERATION
MANUAL**

Loop Tester

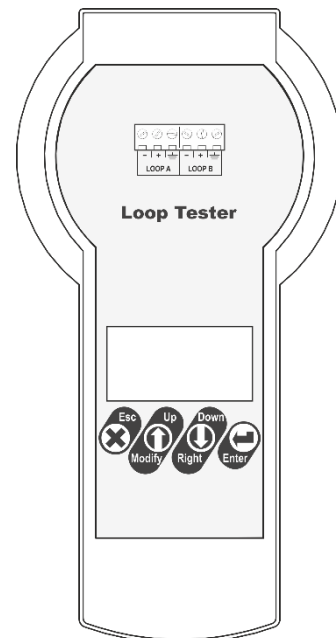

Attention:

This manual contains information on limitations regarding product use and function and information on the limitations as to liability of the manufacturer. The entire manual should be carefully read.

The information in this manual is a subject to change without notice!

Table of Contents

1. Introduction.....	3
1.1. General Description.....	3
1.2. Technical Specification.....	3
1.3. Supplied Equipment in the Kit.....	3
1.4. Preparing the joint connections.....	3
2. Control and Operation Elements.....	4
2.1. Control Unit.....	4
2.2. Buttons' Functionality.....	4
3. Connection Diagrams.....	4
3.1. Loop Connection.....	4
3.2. Topology Diagrams.....	5
4. Operation with the Loop Tester.....	6
4.1. Switching on the Tester.....	6
4.2. Choosing a Language.....	6
4.3. Reading a Topology of a Loop/Line.....	6
4.3.1 Reading of Unaddressed Loop/Line (New installations).....	6
4.3.2 Reading of Addressed Loop/Line (Present installations).....	6
4.4. Perform Cable Tests.....	7
4.4.1 Auto Cable Test.....	7
4.4.2 Single Cable Test.....	8
4.4.3 Searching for Cable Faults.....	8
4.5 Perform Loop Tests.....	9
4.5.1 Loop State.....	9
4.5.2 Loop Tools.....	10
4.5.3 Bisection Method for Faults Searching.....	10
4.5.4 Reading Device Parameters.....	10
4.5.5 Searching Short / Break Faults.....	11
4.5.6 Searching of Devices in Fire Alarm Mode.....	12
4.5.7 Searching for Branch Position.....	12
4.5.8 Turn ON/OFF Device LEDs/Sound.....	12
4.5.9 Checking the Operation Current.....	13
4.6 Addressing Devices Menus.....	13
4.6.1 Autoaddressing by ID Number.....	13
4.6.2 Autoaddressing by Isolator Module.....	14
4.6.3 Selfaddressing of Devices.....	14
4.6.4 Changing the Address of a Device.....	14
5. Quick Menu Structure.....	15
Appendix – SensolRIS Devices.....	15

1. Introduction

1.1. General Description

The Loop Tester is a diagnostic tool specially designed for operation with addressable devices SensolRIS series. The device is suitable for testing the continuity and the technical characteristics of the fire cable and also the operability of the loop and the connected devices.

The Loop Tester can operate with only one loop line. The switching between the loops of the panel is very easy using the supplied clamp terminal blocks.

The time for test may vary according the length of the loop and the number of the connected devices.

Important notes:

- **During the test the loop line must be disconnected from the control panel!**
- **DO NOT connect the fire control panel and the Loop Tester to the loop line simultaneously!**
- **The cable tests have to be done without connected devices to the loop line! If the cable tests are made with connected devices, you must consider that the measured results would not be exact.**
- **For exact results in searching short circuits faults, breaks in the loop line and existing branches is mandatory all devices in the loop/line to be with built-in isolator module – see the corresponding table for SensolRIS addressable devices in the Appendix.**
- **In case of installed devices without isolators in present operating fire alarm systems, you have to consider that they will be displayed as separate branches in the system. When you have to search for branches in a system including devices without connected isolator, we recommend to remove them temporarily before starting mentioned above test procedures.**

1.2. Technical Specification

- Main Power Supply: AC/DC Switching Adapter; input 100-240VAC, 50/60Hz, 1.5A; output 15VDC, 4A, 60W
- Range of the addresses: 1 ÷ 250
- Multilanguage Menus: YES
- Dimensions: 225 x 102 x 65 mm
- Weight: 340g
- Housing material, color: ABS, white
- Nominal Operating Temperature: -5°C ÷ 40°C
- Storage temperature: -20°C ÷ +70°C
- Related Humidity: ≤93% @ +40°C

1.3. Supplied Equipment in the Kit

- Loop Tester Unit – 1 pc
- Power supply adapter – 1 pc
- 2-Cage clamp connector terminal block with levers – 4 pcs
- Conductor wire, red, 120mm, 1.5mm² – 2 pcs
- Conductor wire, black, 120mm, 1.5mm² – 2 pcs

1.4. Preparing the joint connections

The Loop Tester is delivered with a set of wires (2 red and 2 black) and clamp terminals for easier connection to the loop line. You can prepare the joint connections in advance and then follow the description in item 3. Connection diagrams. Use conductor wires with cross-section from 0.14 to 4.00 mm².

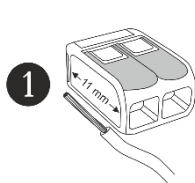

Strip the wire to 11 mm length.

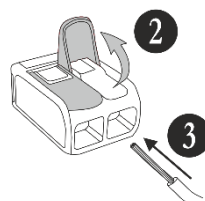

Lift the lever to open the clamp block.
Insert the stripped wire.

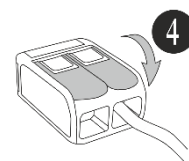

Push the lever backwards to close the clamp block.

2. Control and Operation Elements

2.1. Control Unit

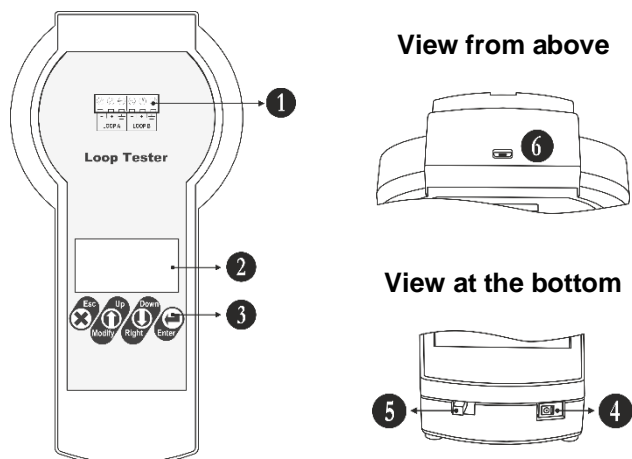

- 1 – Terminal block for connection to the loop line.
- 2 – LCD text display.
- 3 – Operation control buttons.
- 4 – Socket for switching the external power supply adapter.
- 5 – ON/OFF power switch.
- 6 – Micro USB port for firmware and software updates.

2.2. Buttons' Functionality

Button	Function	Description
	Enter	- Confirmation of set parameters. - Starting a test or addressing procedure. - Turn ON/OFF of device LED indication.
	Up	- Scrolling up the menus.
	Modify	- Increasing the numeric digit with one unit.
	Down	- Scrolling down the menus.
	Right (Move)	- Moving the cursor on left/right.
	Esc	- Reject the set parameters. - Exit (one step back) from a sub- or main menu. - Cancellation of test or addressing procedure.

3. Connection Diagrams

3.1. Loop Connection

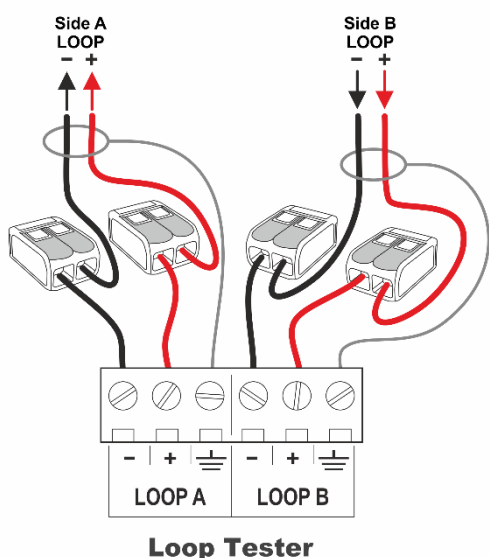

Attention:

The loop line must be disconnected from the control panel before connection to the Loop Tester!

DO NOT connect the fire control panel and the Loop Tester to the loop line simultaneously!

Connect the four ready joint connections (clamp terminal + wire) to the terminal row of the Loop Tester as strictly observe the polarity.

Connect the loop ends (side A and side B) to the respective clamps connected to the terminal row of the Tester. Connect the shield ends of the loop wires to the GND (\equiv) terminals of the Tester.

In case of a connection to a single line, connect to the Loop Side A terminals of the tester, and use bridge connections along to Loop side B terminals.

The following pictures represent a loop and single line connection to the Loop Tester terminal rows.

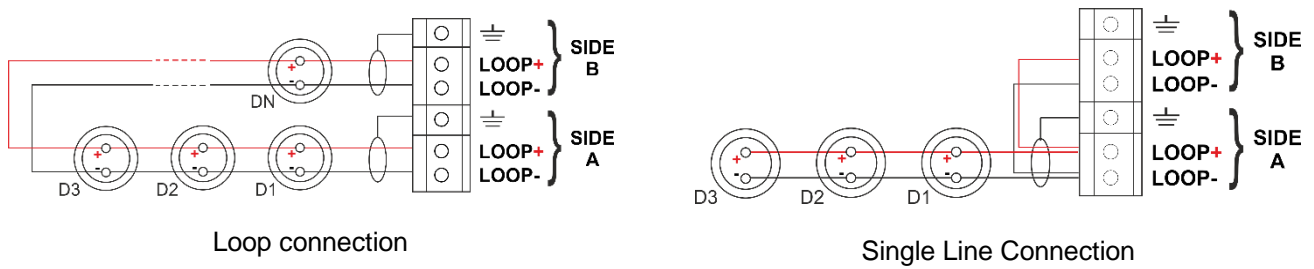

3.2. Topology Diagrams

The following topology types **are allowed** to be used for connection of SensoIRIS series addressable devices:

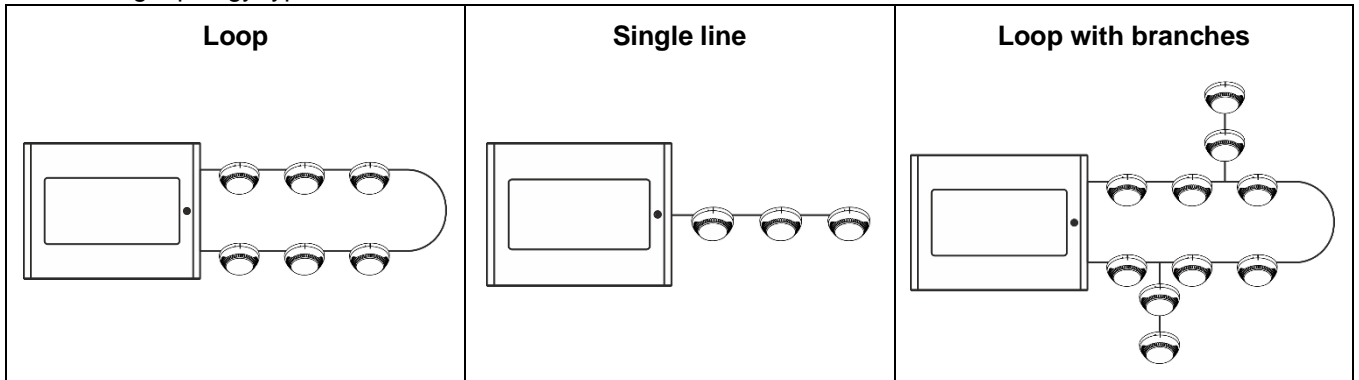

The following topology types **are not allowed** to be used for connection of SensoIRIS series addressable devices. In case of such connection found in the connection loop/line during addressing procedure by isolator (see item 4.6.2), the Loop Tester will display an error message “Branch in Branch” and will abort the operation.

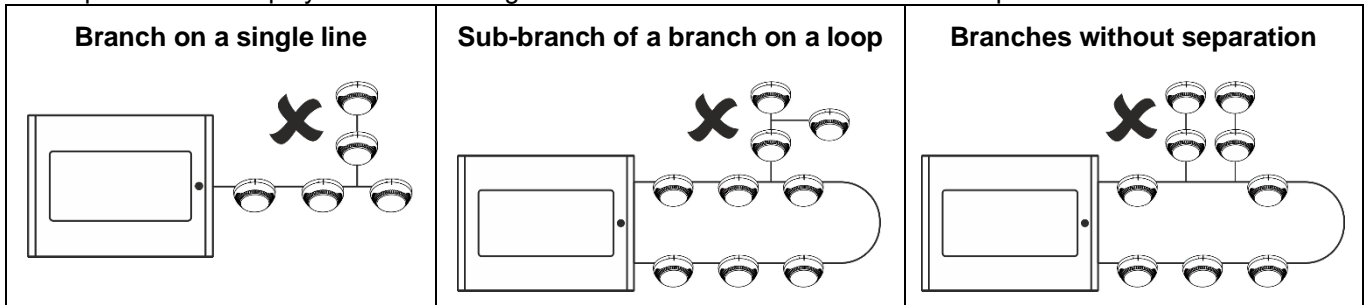

In case of starting a test procedure of an unaddressed loop, the Loop Tester will set sequential addresses to the devices according their order in the loop:

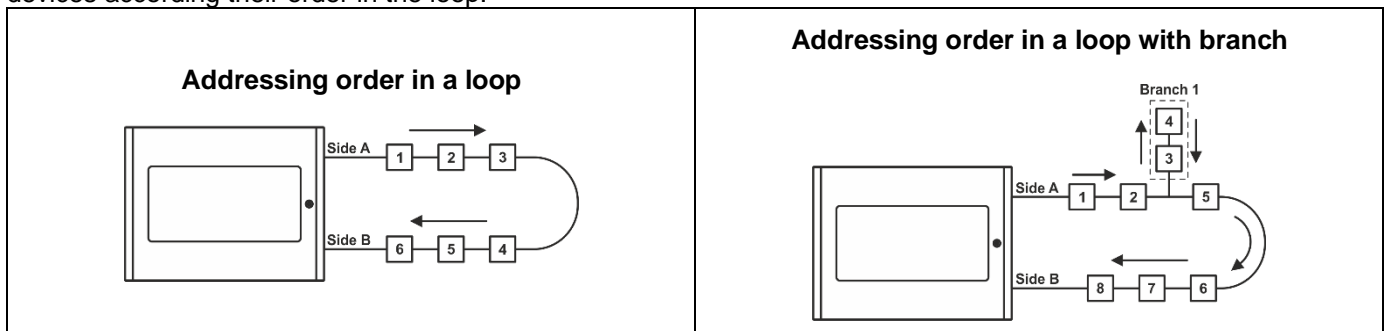

4. Operation with the Loop Tester

4.1. Switching on the Tester

Power on the Loop Tester with the switch (item 2.1, position 5) moving in ON position. The display will show for a while the software version of the device and then will display the main operation menus.

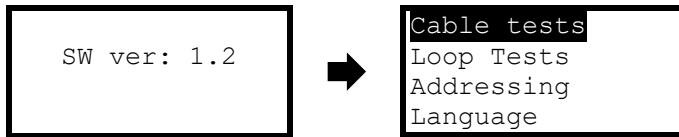

4.2. Choosing a Language

The default set language is English. To set other available language for the setting menus, use the down arrow button to select Language menu and press ENTER button.

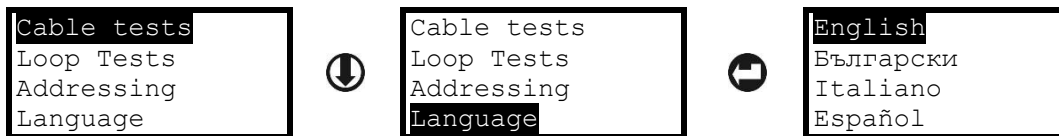

Use the arrows to select the language and confirm the choice with ENTER button. The menus will automatically switch to the new set language.

4.3. Reading a Topology of a Loop/Line

The Loop Tester operation (test and addressing procedures) always starts from Loop Side A to Loop Side B – see item 3.1. A list with available devices in the loop/single line is reviewed in menu *Loop Tests – Loop State* (see item 4.5.1). The devices are displayed as a list according to their set address in the system.

4.3.1 Reading of Unaddressed Loop/Line (New installations)

The advantage of the Loop Tester is that it is possible to read and test the characteristics of the fire cable, connections in a loop or a line, and the mounted addressable devices for the site in advance, before connection to the fire alarm control panel. In new installations the connected devices have no set addresses and the technician has to address them first to perform the loop testing.

To perform testing of a new installation (unaddressed devices) follow the steps:

1. Connect the loop/line wires to the Loop Tester terminals as described in item 3.1.
2. Switch on the Loop Tester.
3. Enter in menu "Loop Test" and choose sub-menu "Loop Tools". Select a test and press ENTER.
4. Select the option "Unaddressed loop" and confirm. Starting the procedure, the Loop Tester will set sequential addresses to the devices according to their order in the loop.

Note: You can run the addressing procedure again and change the set addresses later, when the loop is finally connected to the fire alarm control panel.

4.3.2 Reading of Addressed Loop/Line (Present installations)

Attention: When you use the Loop Tester for diagnostic of present and already operating fire alarm installation, it is strongly recommended first to save the existing configuration using specialised ProSTE programming software!

To perform testing of a present installation (addressed devices) follow the steps:

1. Read the panel configuration with ProSTE software and save it as *.TDF data file.
2. Power off the fire panel.
3. Disconnect the loop wires from the loop expander terminals.
4. Connect the loop/line wires to the Loop Tester terminals as described in item 3.1.
5. Switch on the Loop Tester.
6. Enter in menu "Loop Test" and choose sub-menu "Loop Tools". Select a test and press ENTER.
7. Select the option "Addressed loop" and confirm.

4.4. Perform Cable Tests

This is a menu for performing test of the fire cable used in the installation. The test can be fully automatic or manually selected separate single tests for different electrical values. It is recommended to run first the automatic test for reviewing the general state of the cable and then, if it is necessary, to proceed with single tests. The performed tests are for searching breaks, short circuits or earth fault of installed cable, which can disturb the operability of the loop line.

Attention: The tests must be performed with no connected devices to the cable. If there are connected devices, they have to be disabled or dismantled before running the desired tests.

Select Cable test menu and confirm with the ENTER button. Then choose auto or single cable test.

4.4.1 Auto Cable Test

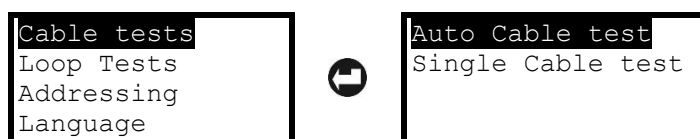

Select this sub-menu to perform fully automatic test of the electrical characteristics of the cable. While the test is running on, the message “Please Wait” is shown on the display. The time for test may vary according the length of the cable.

The results from the test are shown as a list with values and can be reviewed (scrolling up/down) with arrow buttons:

Value	Description	Range limits/Messages
Ua	Measured voltage from the Loop side A. The side A is powered on and then the voltage is measured at the same side of the loop.	15-32V
Ub	Measured voltage from the Loop side B. The side A is powered on, then the side B is powered on and the voltage is measured at side B of the loop. The measurement gives an idea for the voltage drops (from side A to side B), electrical current value and cable resistance.	
R+	The resistance of the positive cable wire. In case “Too High” message is displayed that means there is a break in the cable or a bad contact in the joint connections.	(see item 4.4.3)
R-	The resistance of the negative cable wire. Same as described for “R+”.	
Re	The resistance of the earth cable. Same as described for “R+”.	
Earth Fault	Shows the presence of earth fault problem (or leakage to earth) of the positive or negative wire of the cable* (see item 4.4.3).	None – No fault Yes – Earth fault detected in the cable
Short in cbl.	Shows the presence of short-circuit fault between the positive or negative wire of the cable* (see item 4.4.3).	None – No fault Yes – Short-circuit fault with the cable
Break in cbl.	Shows the presence of breaking in the cable* (see item 4.4.3).	None – No fault Yes – Break fault with the cable

* Note: Use the bisection method for finding and location of the exact place of the fault. The method is described in item 4.5.3.

4.4.2 Single Cable Test

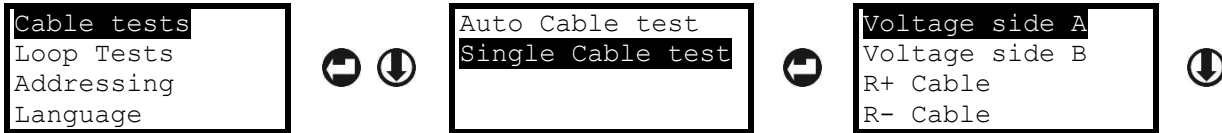

In “Single Cable test” sub-menu, all cable tests (see the table in item 4.4.1) are manually selected and performed according the current needs of the technician. You can scroll with up and down arrow buttons to review the rest of the possible test. The selected test is started with pressing ENTER button. To reject a started test press ESC button. To escape from the “Cable Tests” menus press ESC button several times.

4.4.3 Searching for Cable Faults

If an error message is displayed in “Auto Cable Test” menu, you can run the separate single test again and locate the exact place of the fault. Select a test using the arrows and run it with ENTER button.

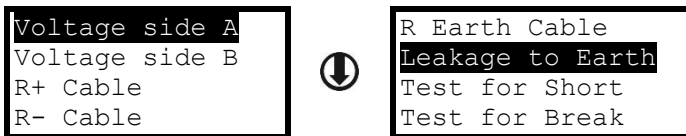

Fault Diagram	Description	Solution
<p>Short-circuit in the cable</p>	<p>Run single test “Test for Short” again to confirm the presence short-circuit in the cable. In case of fault the tester will display message “Short in Cable”.</p>	<p>To locate the place of the short-circuit fault use Bisection method as dividing the cable in equal parts (1/2, 1/4, 1/8, etc), until finding the faulty section. See also item 4.5.3.</p>
<p>Break in the cable</p>	<p>Run single test “Test for Break” again to confirm the presence break in the positive or negative cable wire. In case of fault the tester will display message “Break in Cable”.</p>	<p>To locate the place of the break use Bisection method as dividing the cable in equal parts (1/2, 1/4, 1/8, etc), until finding the faulty section. See also item 4.5.3.</p>
<p>Earth fault in the cable</p>	<p>Run single test “Leakage to Earth” again to confirm the presence earth fault in the positive or negative cable wire. In case of fault the tester will display message “Earth fault”.</p>	<p>Search the earth fault as inspect the grounding components in the cable line, corrupted shield of the cable, etc. You can also use and the Bisection method described in item 4.5.3.</p>
<p>Too High resistance</p>	<p>According the result in the Auto Cable Test menu run the single test for: “R+ Cable” “R- Cable” “R Earth Cable” In case of unusual high resistance found the tester will display message “R+/R-/Re=Too High”.</p>	<p>The error message “Too High” is displayed when the detected resistance in the positive cable wire (R+), negative cable wire (R-) or earth cable (Re) is higher than 400 Ohm. In such cases, it is recommended to check the cable and the joint connections (terminals, base contacts). Check also the cable length – it might be too long.</p>

4.5 Perform Loop Tests

This is a menu for performing test of the loop and the connected devices. It is recommended to run first the “Loop state” automatic test for reviewing the general state of the loop and a list of the connected devices. The general review will help you at the beginning to orientate for current faults, possible breaks or short-circuits in the loop, the number of connected devices and troubles with them.

Attention: To perform more precise tests it is obligatory to use the built-in isolator module for all modules and call points connected to the loop. It is recommended to use detectors and sounders with built-in isolator module (see the table in the Appendix). In installations where, detectors and sounders without built-in isolators are already being used, the results for searching branches and localization of short-circuits and break in the loop can be uncertain. In this case it is recommended for more precise results in searching of errors to be performed and the bisection method (see item 4.5.3).

4.5.1 Loop State

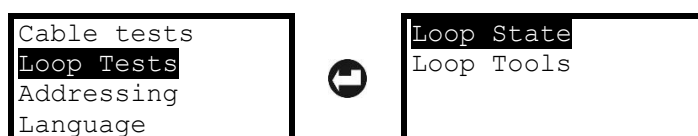

Select “Loop State” menu and press ENTER. The message “Please wait” and a process bar are shown during analysing the current loop state. The time for reading data can vary according the length and the number of connected devices.

The general information is displayed as a list with short messages for the state and can be reviewed (scrolling up/down) with arrow buttons:

Parameter	Description	State Messages
Short Side A	Shows the presence of short circuit at Loop Side A. In case of fault “Yes” message, you can perform a detailed search using menu “Loop Tools” – “Short / Break” (see item 4.5.5).	None – No fault Yes – Short circuit detected at side A.
Short Side B	Shows the presence of short circuit at Loop Side B. In case of fault “Yes” message, you can perform a detailed search using menu “Loop Tools” – “Short / Break” (see item 4.5.5).	None – No fault Yes – Short circuit detected at side B.
Earth Fault	Shows the presence of earth fault in the loop.	None – No fault Yes – Earth fault detected.
Loop Break	Shows the presence of break in the loop. In case of fault “Yes” message, you can perform a detailed search using menu “Loop Tools” – “Short / Break” (see item 4.5.5).	None – No fault Yes – Loop break detected.
Noaddr. Dev.	Shows the presence of devices with no set address in the loop. <i>Note: A possible reason for presence of devices with no set address is performing the Loop State test for an unaddressed loop.</i>	None – No unaddressed devices XXX – Number of found unaddressed devices
Dbl. address	Shows the presence of devices with double address in the loop.	None – No double addresses XXX – Number of found double addresses
Num devices	Shows the current number of the addressed devices in the loop. <i>Note: The number of unaddressed devices and devices with double address are not included into this number.</i>	XXX – Number of addressed devices
Op. curr.	Shows the operating current of the loop. This is average consumption of the connected devices.	Up to 500mA
Devices Table	Shows a list of the available devices and their set address in the system. <i>Note: The found devices with double address are listed at the bottom of the table. The presented numbers for them are not real addresses. In this case is recommended to perform an addressing procedure for the loop and run the Loop State test again.</i>	-

4.5.2 Loop Tools

In this menu are available some test for finding troubles in existing loop installation.



In the “Loop Tools” menu are included the following operations for precise finding of troubles and devices in the loop configuration. You can scroll with up and down arrow buttons to review the rest of the available operations:

- Read parameters
- Short / Break
- Fire position
- Branch position
- Turn ON/OFF
- Operation current

4.5.3 Bisection Method for Faults Searching

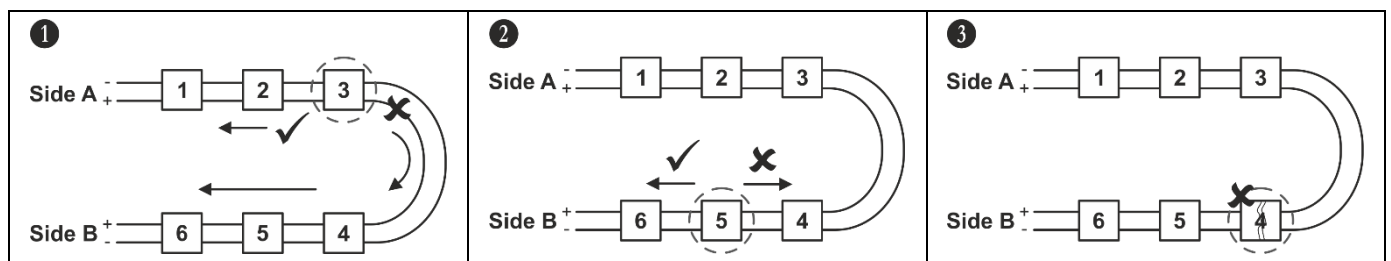

1. Divide the loop into two separate equal lines. Measure the voltage at each line.
2. Divide the faulty line in the center. Restore the earlier connection in the correct line. Measure again the voltage at each line. Thus, you will be able to locate the fault section.
3. Proceed in this way of dividing the faulty section in the center reducing the possible area with fault.

4.5.4 Reading Device Parameters

The “Read parameters” menu is for reviewing the type and some specific information for a device. Select “Read parameters” and press ENTER button. Then using the arrows enter an address number - the buttons functionality is described in item 2.2.

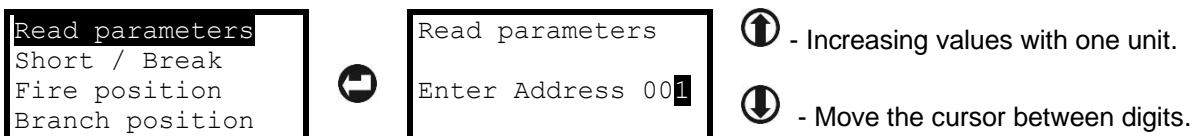

To read the parameters for the device of the selected address press ENTER button. The screen displays the following general information:

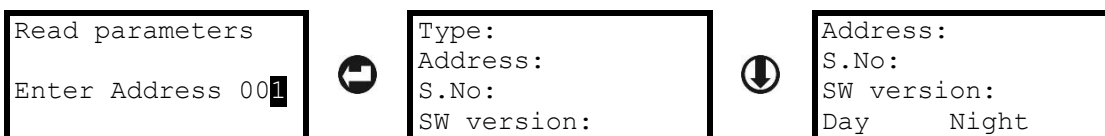

- Type – The name of the device – refer to the table in the Appendix for more details.
- Address – The current set address of the device.
- S.No – The serial number of the device, unique 10 digits number.
- SW version – The software version of the device.
- Day/Night – This parameter is available for reviewing only for detectors. In the field is displayed the set levels for Day and Night operation modes (Low/Normal/Medium/High).

To escape from the “Read parameters” menu, single press ESC button.

4.5.5 Searching Short / Break Faults

Attention: To perform accurate tests for finding of Short and Break position in the loop is mandatory all of the devices in the loop to have a built-in isolator module!

The “Short / Break” menu is for searching the exact place of short-circuit or a break in the loop.

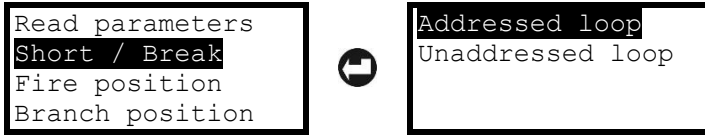

According the organization of the system configuration there are two approaches to start test:

- Addressed loop – Use this option, when the devices in the loop are with already set address numbers. The searching will follow the set addresses in the loop and will display the faults according their order.
- Unaddressed loop – Use this option, when all or some devices are undressed. Before starting the test, the tester will erase the current addresses and will set new to all devices according the ID number.

After choosing an approach to proceed the tester starts consistent tests for short-circuit and break faults. The test is started with pressing the ENTER button. During analysing, a message “Please wait” and a process bar are displayed on the screen. The time for analysing can vary according the length of the loop and the number of faults.

The results are displayed with text messages pointing the place of the fault. Below is presented a quick table for possible faults.

Fault Diagram	Description and Display	Solution
	<p>A short-circuit is detected between devices 2 and 3 in the loop.</p> <pre style="border: 1px solid black; padding: 5px;">Short at: Dev.Type 002 Dev.Type 003</pre>	<p>Locate the place of the displayed devices and check the cable section between them. <i>Tip: You can locate the exact place of a device as turning ON its LEDs (or sound signal for sounders) – see item 4.5.8.</i></p>
	<p>A break in the loop is detected between devices 2 and 3 in the loop. The tester will locate the place searching from both sides A and B.</p> <pre style="border: 1px solid black; padding: 5px;">Break between: 002 dev from SideA 004 dev from SideB Find location >>></pre> <p>The displayed numbers are the counted devices from the two sides of the found break. To find the exact location of the break fault, press ENTER button and confirm with “Yes” command to continue. When the test is over, the screen displays the address of the device after which the break is detected.</p> <pre style="border: 1px solid black; padding: 5px;">Break after: Dev.Type 002</pre>	<p>Locate the place of the displayed devices and check the cable section between them. The break in the loop may be caused and from bad connections to the device terminals (bad joint contacts to the base terminals for detectors and sounders also). <i>Tip: You can locate the exact place of a device as turning ON its LEDs (or sound signal for sounders) – see item 4.5.8.</i></p>

4.5.6 Searching of Devices in Fire Alarm Mode

In this menu the technician can review if there are activated manual call points in the system. The test can be performed for checking the correct operation of the connected call point to loop. Select “Fire position” and press ENTER button. During the analysing process a message “Please wait” and a processing bar are displayed on the screen. If there are activated manual call points, they will be displayed with their address number.

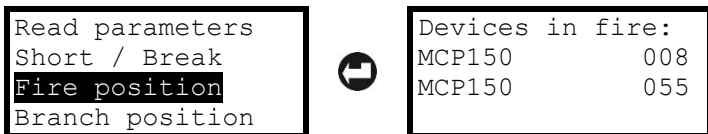

To escape from the “Fire position” menu, single press ESC button.

4.5.7 Searching for Branch Position

The branch is a sub-loop to the main loop. The connection topology diagrams are presented in item 3.2.

Attention: To perform accurate localization of the Branch position in the loop is mandatory all of the devices in the loop to have a built-in isolator module!

In case of presence of devices without isolator, after performing this test they will be reported with type and address and the branch search will be cancelled. For this reason, the devices without isolator, if present at the site, must be removed in advance, before performing branch searching.

The presence of Short circuit and Break in the loop will generate an error message and the branch searching process will be aborted.

Select “Branch position” and press ENTER button. During the analysing process a message “Please wait” and a processing bar are displayed on the screen. The tester starts searching and during the test will show the total number of addressed devices found in the loop (note that if a device is removed temporarily it will not be included into this number). At the last row is presented the real time searching as the tester goes through the loop devices. At the final results screen are displayed the total number of found branches followed by the location where the first one starts and the number of included devices into it. If there is more than branch into the loop, the list can be reviewed with the arrow buttons.

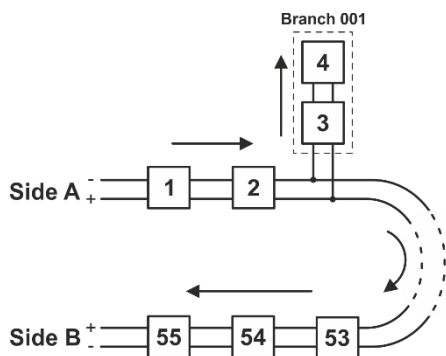
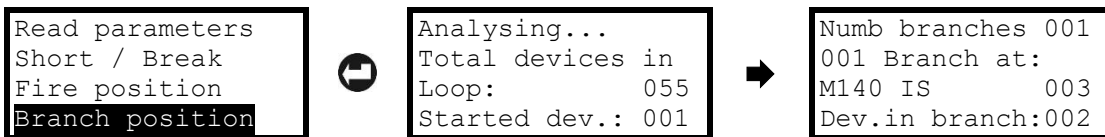

Example for representing the described configuration above: The Branch 001 is started with detector with set address 003, and includes 2 devices in total (addresses 003 and 004).

You can locate the exact place of all devices included into the branch as turning ON their LEDs (or sound signal for sounders), starting with the first one displayed with the tester – see also item 4.5.8.

Note: In real installation the addresses may not be in consecutive order as displayed in the example. It is recommended when searching for branches to refer also to the electrical schematic diagrams of the built fire alarm installation at the site.

4.5.8 Turn ON/OFF Device LEDs/Sound

This is a menu for location of exact place of a device in a fire installation with switching ON its LEDs (or sound signal for sounders). From the main “Loop tools” menu use down arrow to select the “Turn ON/OFF” sub-menu and press ENTER button.

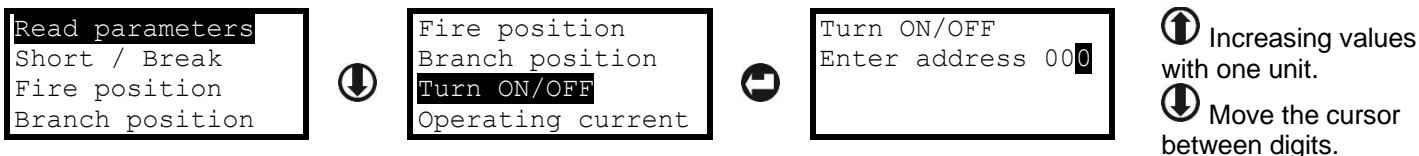

Use the arrow buttons to select and address of a device and press ENTER button. A field “Turn ON” is appeared on the screen. Press ENTER button again to activate the LED indication of the device. The field is changed to “Turn OFF” and the LEDs of the device are switched on*.

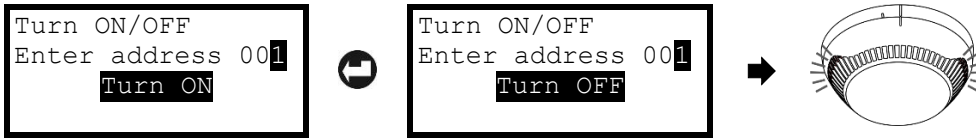

To switch off the LED indication press the ENTER button again – the field is changed to “Turn ON”. To select new address for check, press ESC button – the field “Turn ON” is removed and the section for entering and address starts blinking waiting new number to be entered.

**Note: For sounders with strobe, together with the LED indication is switched on and a sound signal. For sounders without strobe option is turned on only sound signal.*

To escape from the “Turn ON/OFF” menu, single press ESC button.

4.5.9 Checking the Operation Current

This is a menu for checking the operation current in the loop – the average consumption of the connected devices in the loop. The maximum current consumption of the devices in the loop is $I_{max} = 500mA$. If the consumption exceeds this value an over-load protection would be turned on.

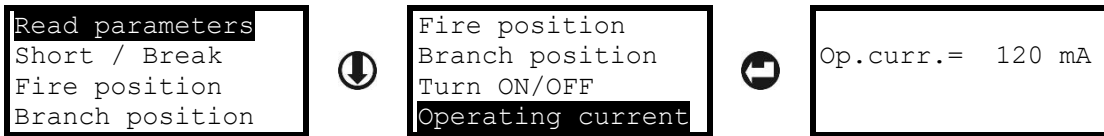

To escape from the “Operating current” menu, single press ESC button.

4.6 Addressing Devices Menus

In the “Addressing” section are accessible menus for different type of addressing devices in the loop. The menus are common with those available in IRIS/SIMPON fire alarm panels. The menus allow performing two auto addressing procedures by ID number or by isolator module (IS). The self-addressing procedure is used for quick adding of new devices to free addresses. The last menu is for quick changing the current address of a device.

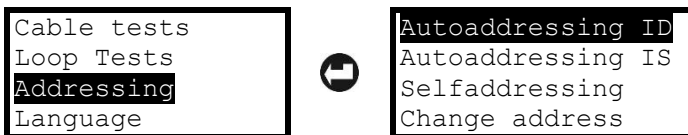

Attention: Performing the auto addressing procedures by ID number and by Isolator module, will erase all currently set address numbers of the devices in the loop.

4.6.1 Autoaddressing by ID Number

The addressing procedure follows the order of the ID numbers of the devices connected to the line. The order is according the device type starting with the smallest ID number in the loop: modules, sounders, detectors and manual call points. It is possible to address devices with and without built-in isolator modules. No restrictions for addressing detectors into branches.

Select “Autoaddressing ID” menu and press ENTER button. To start the procedure, select “Yes” option and press ENTER again.

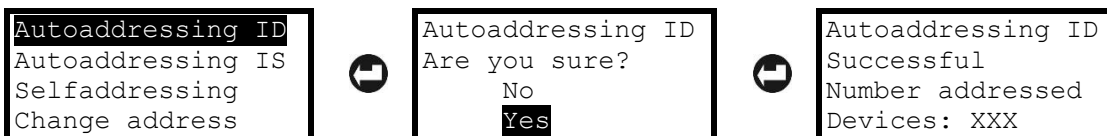

After successful addressing a message “Successful” will appear on the screen followed from the total number of addressed devices. The order of addressing can be reviewed in “Loop State” menu – see item 4.5.1.

To escape from the “Autoaddressing ID” menu, press ESC button.

4.6.2 Autoaddressing by Isolator Module

This way requires all of the devices connected to the line to have a built-in or connected to the loop isolator module. The tester starts the addressing of devices according to their place following the order in the loop from side A to side B – see item 3.1. There are some restrictions for addressing the detectors included into branches – see item 3.2.

Select “Autoaddressing IS” menu and press ENTER button. To start the procedure, select “Yes” option and press ENTER again. During the addressing procedure, the screen displays the current number of found addressed devices and the number of found branches.

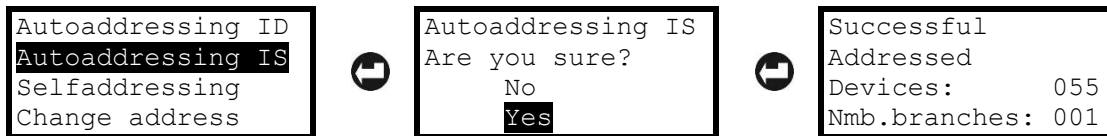

After successful addressing a message “Successful” will appear on the screen followed from the total number of addressed devices and the total number of found branches. The order of addressed devices can be reviewed in “Loop State” menu – see item 4.5.1. The branch position can be reviewed in “Loop Tools” menus – see item 4.5.7.

Note: The addressing can be unsuccessful in case of found devices without isolator in the loop. In this case a fault message “Branch in branch” will display on the screen and the addressing is aborted. It is recommended before starting addressing by isolator module first to remove the devices without isolator module from the loop.

To escape from the “Autoaddressing IS” menu, press ESC button.

4.6.3 Selfaddressing of Devices

During this addressing procedure, the devices are added one by one to the loop (currently the detectors and sounders are not mounted to the bases; the call points and modules are not connected to the loop). Select “Selfaddressing” menu and press ENTER button. The tester will start checking the current configuration as during the process a message “Please wait” and a processing bar are displayed on the screen. When the reading is complete the screen displays the total number of found addresses and the next free address in the system.

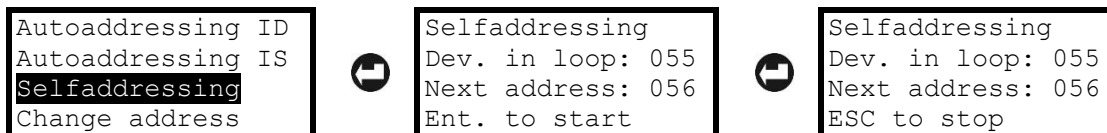

Press ENTER button to begin selfaddressing. Start to mount detectors one by-one. The tester will set the displayed address number to the mounted device and automatically proceeds with next free address in the system. Every device will confirm the new set address: with LED indication and/or with sound signal for sounders. When all the new devices are added press ESC button to stop the procedure.

4.6.4 Changing the Address of a Device

In this menu the technician can change the current address of a device. Select “Change address” menu and press ENTER button. The tester will start checking the current configuration as during the process a message “Please wait” is displayed on the screen. When the reading is complete the screen displays two fields for setting the current address and the new address for the device. Use arrow buttons to set address for changing and press ENTER button. The field “Set new addr” becomes active. Set the new address and press ENTER to confirm.

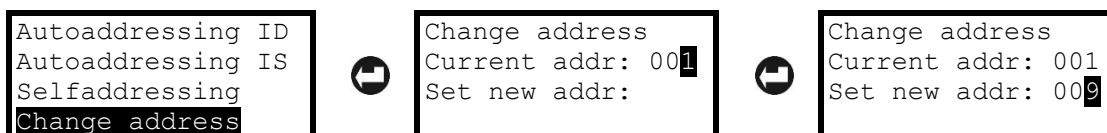

After successful changing a message “Successful” will appear on the last row of the screen. If “Busy new address” message is displayed on the last row that means the selected new address is already used in the system configuration. In that case press ESC button to start the procedure again. If “No device at:” message followed from an address number is displayed, that means no real device is found on the current set address. In that case press ESC button to start the procedure again.

5. Quick Menu Structure

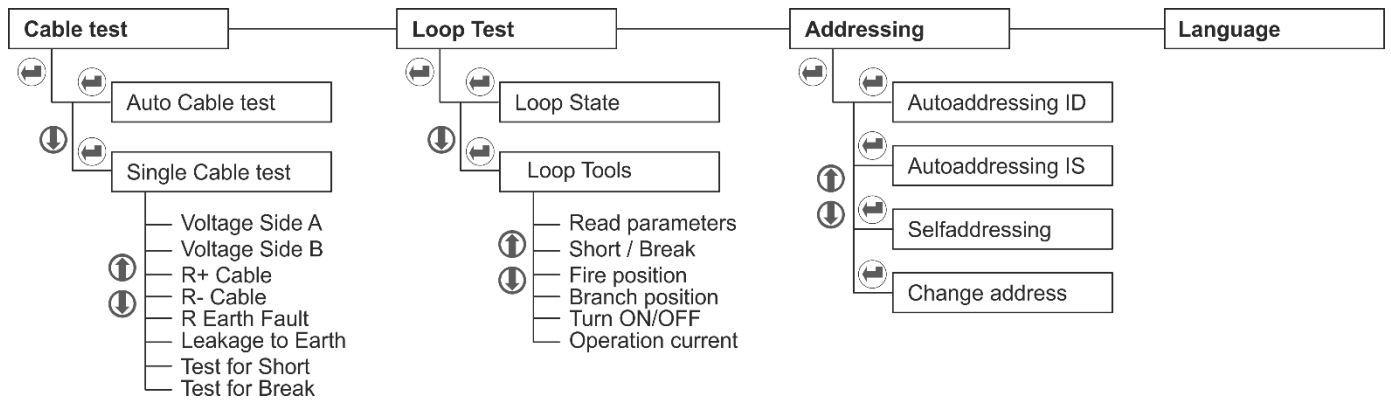

Appendix – SensolRIS Devices

Device Name	Description	Isolator Module Available
S130	Optical-smoke detector	No
S130 IS	Optical-smoke detector	Yes (built-in)
T110	Temperature detector	No
T110 IS	Temperature detector	Yes (built-in)
M140	Combined detector	No
M140 IS	Combined detector	Yes (built-in)
MCP150	Manual call point	Yes (must be connected during installation)
WSOU	Sounder	No
WSOU IS	Sounder	Yes (built-in)
WSST / WS	Sounder and strobe	No
WSST IS / WS IS	Sounder and strobe	Yes (built-in)
BSOU	Base with sounder	No
BSOU IS	Base with sounder	Yes (built-in)
BSST	Base with sounder and strobe	No
BSST IS	Base with sounder and strobe	Yes (built-in)
MIO 04	Module with 4 outputs	Yes (must be connected during installation)
MIO 40	Module with 4 inputs	Yes (must be connected during installation)
MIO 22	Module with 2 inputs/2 outputs	Yes (must be connected during installation)
MIO 22M	Module with 2 inputs/2 monitored outputs	Yes (must be connected during installation)
MOU	Module with 1 output	Yes (must be connected during installation)
MOU-240	Module 240V interface with 1 output	Yes (must be connected during installation)
MINP M	Mini module with 1 monitored input	No
MC-Z	Conventional zone module	Yes (must be connected during installation)



Teletek

electronics

www.teletek-electronics.com

Address: Bulgaria, 1407 Sofia, 14A Srebarna Str.
Tel.: +359 2 9694 800, Fax: +359 2 962 52 13
e-mail: info@teletek-electronics.bg