



# **ANPR System**

## **Installation Guide**







# Foreword

## General

This installation guide (hereinafter referred to as the "Guide") introduces the structure, installation, wiring, and commissioning of AI enforcement camera system. It is designed to guide engineering technicians, contractors, and more for device installation and commissioning

## Safety Instructions

The following categorized signal words with defined meaning might appear in the Guide.

Signal Words	Meaning
 <b>DANGER</b>	Indicates a high potential hazard which, if not avoided, will result in death or serious injury.
 <b>WARNING</b>	Indicates a medium or low potential hazard which, if not avoided, could result in slight or moderate injury.
 <b>CAUTION</b>	Indicates a potential risk which, if not avoided, may result in property damage, data loss, lower performance, or unpredictable result.
 <b>TIPS</b>	Provides methods to help you solve a problem or save you time.
 <b>NOTE</b>	Provides additional information as the emphasis and supplement to the text.

## Revision History

Version	Revision Content	Release Time
V1.0.0	First release.	August 2020

# Important Safeguards and Warnings

## Operation Requirement

- Do not place or install the device in a place exposed to sunlight or near the heat source.
- Keep the device away from dampness, dust or soot.
- Keep the device installed horizontally on the stable place to prevent it from falling.
- Do not drop or splash liquid onto the device, and make sure there is no object filled with liquid on the Camera to prevent liquid from flowing into the device.
- Install the device in a well-ventilated place, and do not block the ventilation of the Camera.
- Operate the device within the rated range of power input and output.
- Do not disassemble the device.
- Transport, use and store the device under the allowed humidity and temperature conditions.

## Electrical Safety

- Improper battery use might result in fire, explosion, or inflammation.
- When replacing battery, make sure the same model is used.
- Use the recommended power cables in the region and conform to the rated power specification.
- Use the power adapter provided with the device; otherwise, it might result in people injury and device damage.
- The power source shall conform to the requirement of the Safety Extra Low Voltage (SELV) standard, and supply power with rated voltage which conforms to Limited power Source requirement according to IEC60950-1. Please note that the power supply requirement is subject to the device label.
- Connect the device (I-type structure) to the power socket with protective earthing.
- The appliance coupler is a disconnection device. When using the coupler, keep the angle for easy operation.

## Maintenance Requirement

- Do not try to disassemble the device yourself.
- Do not touch charge-coupled device (CCD) or complementary metal oxide semiconductor (CMOS) directly. Use a blower to remove dust or dirt from the sensor surface.
- Use a soft, dry and clean cloth soaked with a small amount of neutral detergent to clean the Camera.

## Declarations

- Please read the Guide carefully before installation. Keep the Guide properly for future reference.
- Pay attention to factors such as environmental requirements, application scenarios to avoid error of system caused by external factors.
- Illustrations and descriptions of devices in the Guide are for reference only, and the actual devices shall prevail.
- Devices and software subject to change without further notice.
- For latest programs and additional files, please contact our customer service.

## Construction Safety Instructions

- Construction workers must wear protective equipment such as reflective vest to ensure safety during construction.
- Construction sites must be blocked off and placed with signs. Specific requirements are as follows:
- **Work on city road:** Place in sequence work zone warning sign, work zone speed limit sign, and traffic guidance sign 150 meters away of coming vehicles from the work zone. In addition, put work zone safety barriers at reasonable intervals to form a safe work zone and protect workers' safety.
- **Work on expressway:** Put work zone warning sign at safe area (such as near hard shoulder or crash barrier) and 1.5 km away of coming vehicles from the work zone. In addition, place in sequence work zone speed limit sign, traffic guidance sign, and work zone distance sign around 150 meters to the work zone. Put work zone safety barriers at reasonable intervals to form a safe work zone, and place traffic guidance sign at corners of the work zone. Put sign of canceling work zone speed limit at a safe place 150 meters away of leaving vehicles from the work zone.
- **Lifting work or aerial work:** The work zone must be placed with clear danger sign and danger warning light at night. Responsible person should be designated to guide people to detour. Do not enter or stay in work area.
- **Aerial work platform:** Make sure that its parking position is ideal for aerial work. Check whether the support legs of aerial work platform are put in place to support the telescopic boom, and whether heavy-current circuit is connected within the work zone. Make sure the boom will not touch any object when it is extended.
- Workers should fasten safety belt and wear helmet, and properly place equipment, tools and personal belongings to prevent injuries from falling objects.
- **Heavy current engineering:** During wiring, joint with the heavy current part exposed should be wrapped with insulated and waterproof tape, which will be put into waterproof insulated box. When the device is connected to heavy current, make sure the circuit works, and the insulation cover of cable is inserted into terminal to prevent the insulation cover separating from the copper wire, resulting in the copper wire exposed. For old wire construction, make sure no power is connected, and then start construction.
- **Grounding:** Make sure all electric devices are properly grounded during construction.

# Table of Contents

<b>Foreword</b> .....	<b>I</b>
<b>Important Safeguards and Warnings</b> .....	<b>II</b>
<b>Table of Contents</b> .....	<b>IV</b>
<b>1 Device List</b> .....	<b>5</b>
<b>2 System Structure</b> .....	<b>6</b>
<b>3 Devices and Accessories</b> .....	<b>7</b>
3.1 Devices .....	7
3.1.1 AI Enforcement Camera .....	7
3.1.2 Lens .....	7
3.1.3 Radar .....	7
3.1.4 Edge Storage Device.....	9
3.2 Accessories .....	11
3.2.1 Bracket and Protective Cover.....	11
3.2.2 Cable.....	12
3.2.3 Traffic Pole .....	12
3.2.4 Outdoor Distribution Board.....	12
3.2.5 Air Switch, Power Surge Protector, Ethernet Surge Protector .....	13
3.2.6 Fiber Optical Transceiver and Switch (Optional).....	13
<b>4 Installation</b> .....	<b>14</b>
4.1 Installation Diagram .....	14
4.2 Installation Notes .....	15
4.3 Installing Radar .....	16
4.4 Installing Edge Storage Device.....	17
<b>5 Wiring</b> .....	<b>19</b>
5.1 Wiring Diagram .....	19
5.2 Connecting Camera Power Cable .....	19
5.3 Wiring Radar .....	19
5.4 Connecting Radar Power Cable .....	20
<b>6 Commissioning</b> .....	<b>21</b>
6.1 Configuring Radar.....	21
6.2 Commissioning Radar.....	22
6.3 Commissioning Strobe.....	23

# 1 Device List



- Protective equipment is not included in the list.
- The system must be configured with power surge protector and Ethernet surge protector.
- The device list in the Guide is for reference only, and the actual devices shall prevail.

Table 1-1 Device list

Device	Material No.	Model	Quantity	Note
AI enforcement camera	1.0.01.09.12647	DHI-ITC431-RW1 F-L	1	Models with "-L" are designed with built-in white light strobe, models with "-IR" supports IR during night time.
	1.0.01.09.12649	DHI-ITC431-RW1 F-IRL8		
Universal mounting bracket	1.2.01.13.1207	8018	1	3-dimensional universal mounting bracket, needs to be purchased separately
Bracket	1.1.02.08.11914	PFA150	1	Mounting bracket, needs to be purchased separately
Edge storage device	1.0.01.09.10329	DHI-ITSE0804-G N5B-D	1	1.0.01.09.0237 DH-ITSE0400-GN5A-B (optional)
Radar detector	1.0.01.09.10282	DHI-ITARD-024S A-ST	3	
Multi-target ANPR radar	1.2.01.69.10225	DHI-ITARD-024M A-H	1	
Signal detector	1.0.01.09.0129	DH-ITASD-012B	1	

## 2 System Structure

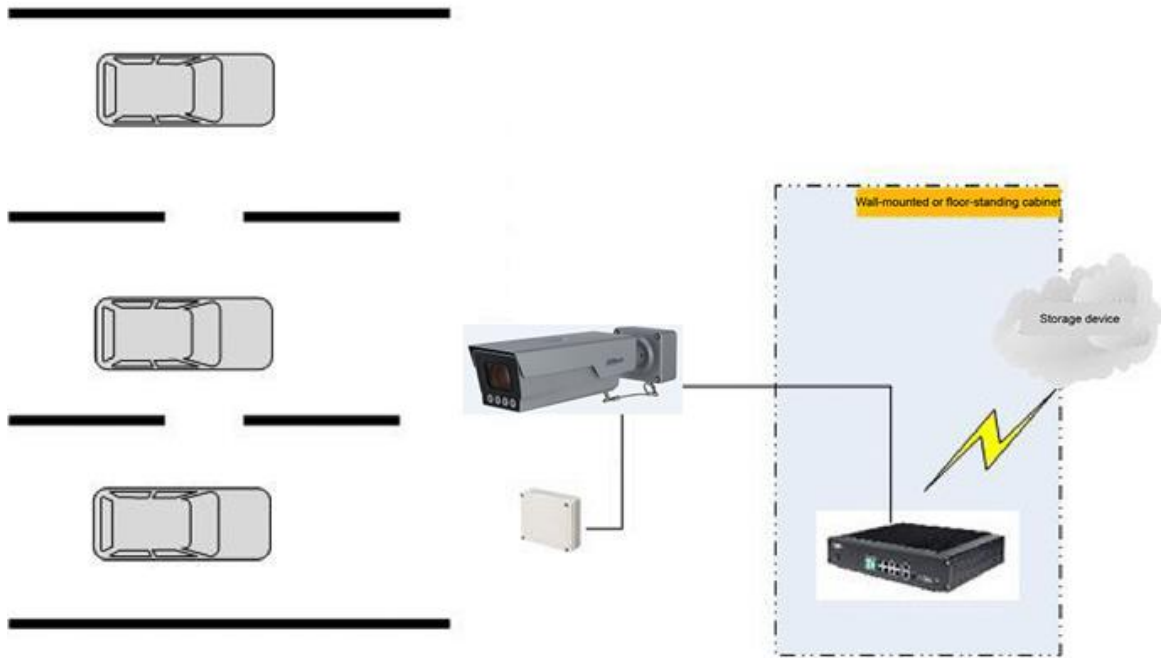

# 3 Devices and Accessories

## 3.1 Devices

### 3.1.1 AI Enforcement Camera



### 3.1.2 Lens

Built-in 10.5mm–42mm lens.

### 3.1.3 Radar

#### DHI-ITARD-024SA-ST radar

This radar is an integrated traffic auxiliary product with a high degree of intelligence in the field of intelligent transportation for dynamic detection of moving vehicles.

It can detect vehicles of 1 lane. The radar is featured by high speed detection accuracy (deviation within  $\pm 1\text{km/h}$ ), strong anti-interference capability, and high detection rate; low microwave radiation and power consumption.

Figure 3-1 Dimensions

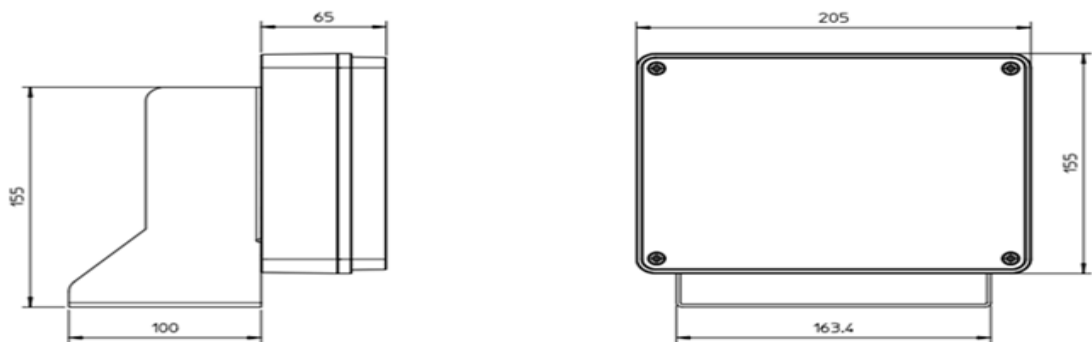

Table 3-1 DHI-ITARD-024SA-ST radar parameters

Parameter	Description
Model	ITARD-024SA-ST
Antenna Type	Microstrip patch array antenna
Radar System	Continuous wave
Microwave	24.125 GHz



Parameter	Description
frequency	
Transmit power	20 dBm
Antenna 3dB beamwidth	6.5° (H) × 5.5° (V)
AD sampling frequency	25 kHz
Work mode	Forward direction
Number of lane	Single lane
Detection information	Vehicle speed (instantaneous speed)
Capture rate	≥ 95%
Speed detection accuracy	±1 km/h
Speed detection range	3–250 km/h
Snapshot distance	Optimum snapshot distance: 18 m (mounting height: about 6 m)
Communications interface	Standard RS-232
Cables	Red: 12V+ DC or 24V1 AC. Black: 12 V- DC or 24V2 AC. White: Trigger out. Yellow: RS-232 RXD. Green: RS-232 TXD. Brown: RS-232 GND
Power input	12 V DC and 24 V AC, provides safe and stable power supply with overvoltage, overcurrent and reverse connection protection.
Interface protection	Output interfaces are designed with overvoltage and overcurrent protection.
Working environment	Temperature: -30 °C to +70 °C Humidity: 10% to 90%
Dimensions	Radar: 205 × 155 × 65 mm Bracket: 163.4 × 100 × 155 mm
Weight	1 kg (bracket excluded)

### DHI-ITARD-024MA-H Radar

The radar can be installed at any position above the lane to detect vehicles of 1–4 lane(s) within 15–45 m. This radar also sends snapshot trigger signal when a vehicle arrives at designated position, and detects the lane and the vehicle speed.

#### Features

- One radar can detect up to 32 vehicles from 1–4 lanes.
- Precisely detects speed and position of vehicles within 18–35 m.
- Flexible installation (front mount or side mount), commissioning through wireless handheld device, and visual commissioning interface.
- Capable of detecting vehicles making U turns or changing lanes.

- Detection performance is not influenced by vehicles of adjacent lanes, or vehicles from the front or back side.
- All-weather and all-time.  
Detection performance is not influenced by environmental factors such as sunlight, dust, adverse weather, and temperature.
- High capture rate.  
99% (smooth traffic), 96% (saturated traffic), 92% (congestion).
- Precise positioning.  
Positioning accuracy of vehicle capture trigger signal:  $\pm 0.5\text{m}$ .

Table 3-2 DHI-ITARD-024MA-H radar parameters

Parameter	Description
Detection distance	15–45 m
Positioning distance	18–35 m
Positioning precision	$\pm 0.5$ m
Speed detection range	5–350 km/h
Speed detection error	-1.0km/h to 0
Lane width	2–4 m
MU-1 beamwidth coverage	3 m
Microwave frequency	24.15 GHz
Transmission frequency error	< 1 MHz
Frequency modulation bandwidth	250 MHz
Effective isotropic radiated power (EIRP)	< 20 dBm
Refresh time	50 ms
Communication interface	RS-485/RS-232/Wifi
Baud rate	9600 bps – 256000 bps
Radar system	FMCW + Monopulse + Doppler, 3-antenna
Temperature range	-40°C to +85°C
Mounting height	5–10 m
Power supply	12 V DC
Real power consumption	< 3.5 W
Mechanical property	LEXAN housing material, complies with NEMA6 and IP67
Dimensions	168 x 140 x 50 mm (L x W x H)

### 3.1.4 Edge Storage Device

This Guide uses DH-ITSE0400-GN5A-B edge storage device. This edge storage device can encode and decode JPEG and H.264 streams. It has 1T capacity by default, and it is designed with one built-in SATA interface (supports 2.5-inch HDD) for expanding capacity. The device also supports ANR (automatic network replenishment), query of pictures and video records, snapshot and video recording of violations, and more. See Figure 3-2 and Table 3-3.

Figure 3-2 Edge storage device



Table 3-3 Edge storage device parameters

Parameter	Description
Operating system	Embedded Linux
Operation interface	Web
Video input	4-channel network compression HD video input
Alarm input	2-channel alarm input
Alarm output	2-channel alarm output, relay contact
Storage	2 built-in SATA ports (2.5-inch HDD)
RS-232 port	2, used for debugging serial port data.
RS-485 port	1, supports multiple protocols.
USB port	1 external USB2.0 port.
Ethernet port	2 RJ45 100M/1000M self-adaptive Ethernet ports, and 4 RJ45 100M industrial-grade switch network ports.
Power interface	12 V DC
Clock	Built-in RTC (real-time clock)
Indicator light	1 activity indicator
Power consumption	Higher than -10°C: < 20W (without HDD), < 30W (with HDD); lower than -10°C: 40 W (heating).
Operating temperature	-30 °C to 70 °C (-4 °F to 158 °F)
Working humidity	Less than 95%
Air pressure	86 kpa to 106 kpa
Dimensions	210 × 138 × 52 mm
Mounting	Desktop mounted

Figure 3-3 Front panel

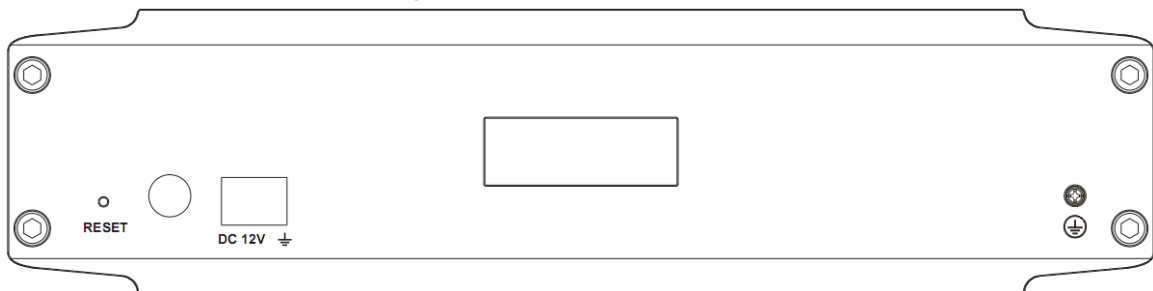

Table 3-4 Front panel interface

Interface	Description
-----------	-------------

RESET	Reset button. <ul style="list-style-type: none"> <li>Restore default factory settings.</li> <li>How to reset: Press and hold the reset button for at least 10 s when the cameras is running (the power indicator is green), then the system configuration will restore factory default settings.</li> </ul>
12 V DC	Power interface.

Figure 3-4 Rear panel

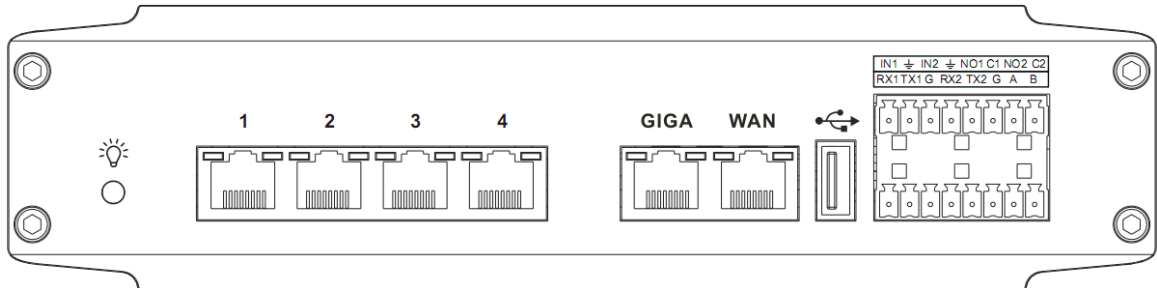

Table 3-5 Rear panel interface

Interface/Button	Description
	Activity indicator <ul style="list-style-type: none"> <li>Activity indicator keeps on when the device is running.</li> <li>Activity indicator flashes when upgrading program.</li> </ul>
1, 2, 3, 4	RJ45 100M switch network port.
GIGA	100M/1000M self-adaptive Ethernet port (the same network segment with the switch).
WAN	100M/1000M self-adaptive Ethernet port.
	USB port.
IN1, IN2	Alarm input port, receives the on-off signal of external alarm source.
	Ground.
NO1, NO2	Normally-on alarm output port.
C1, C2	Common alarm output port.

## 3.2 Accessories

### 3.2.1 Bracket and Protective Cover

#### 8018 Bracket

Figure 3-5 Bracket

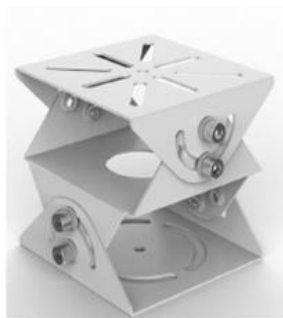

Table 3-6 Bracket parameters

Parameter	Description
Material	Die casting aluminum
Mounting	Wall-mounted
Load bearing	20 kg
Supported product	DHI-ITABX-018BA protective cover
Weight	1.1 kg
Length	120 × 103 × 85 mm

### 3.2.2 Cable

Cables used in the Guide are as follows:

- Ethernet cable: CAT5E FTP;
- 220 V AC power cable: RVV3 × 1.5<sup>2</sup>;
- Camera power cable: RVV3 × 1.5<sup>2</sup>;
- Flashing light trigger cable: RVSP2 × 0.5<sup>2</sup>;
- Strobe trigger cable: RVSP2 × 0.5<sup>2</sup>;
- Radar power supply cable: RVSP4 × 0.5<sup>2</sup>.

### 3.2.3 Traffic Pole

It is used for fixing camera, flashing light, and strobe. Size of traffic pole depends on the actual construction requirements. The pole should be resistant to level 12 typhoon and level 6 earthquake.

### 3.2.4 Outdoor Distribution Board

It is used for installing air switch, surge protector, signal detector, socket, fiber splice tray, etc. The distribution board should reach IP54 protection level, and be designed with built-in temperature controller and fan.

### **3.2.5 Air Switch, Power Surge Protector, Ethernet Surge Protector**

We recommend to using CHNT air switch, DXH06-F power surge protector, and FRX-SL-RJ45 Ethernet surge protector.

### **3.2.6 Fiber Optical Transceiver and Switch (Optional)**

We recommend to using industrial-grade switch and HF-500 fiber optical transceiver.

# 4 Installation

## 4.1 Installation Diagram

Figure 4-1 Installation diagram

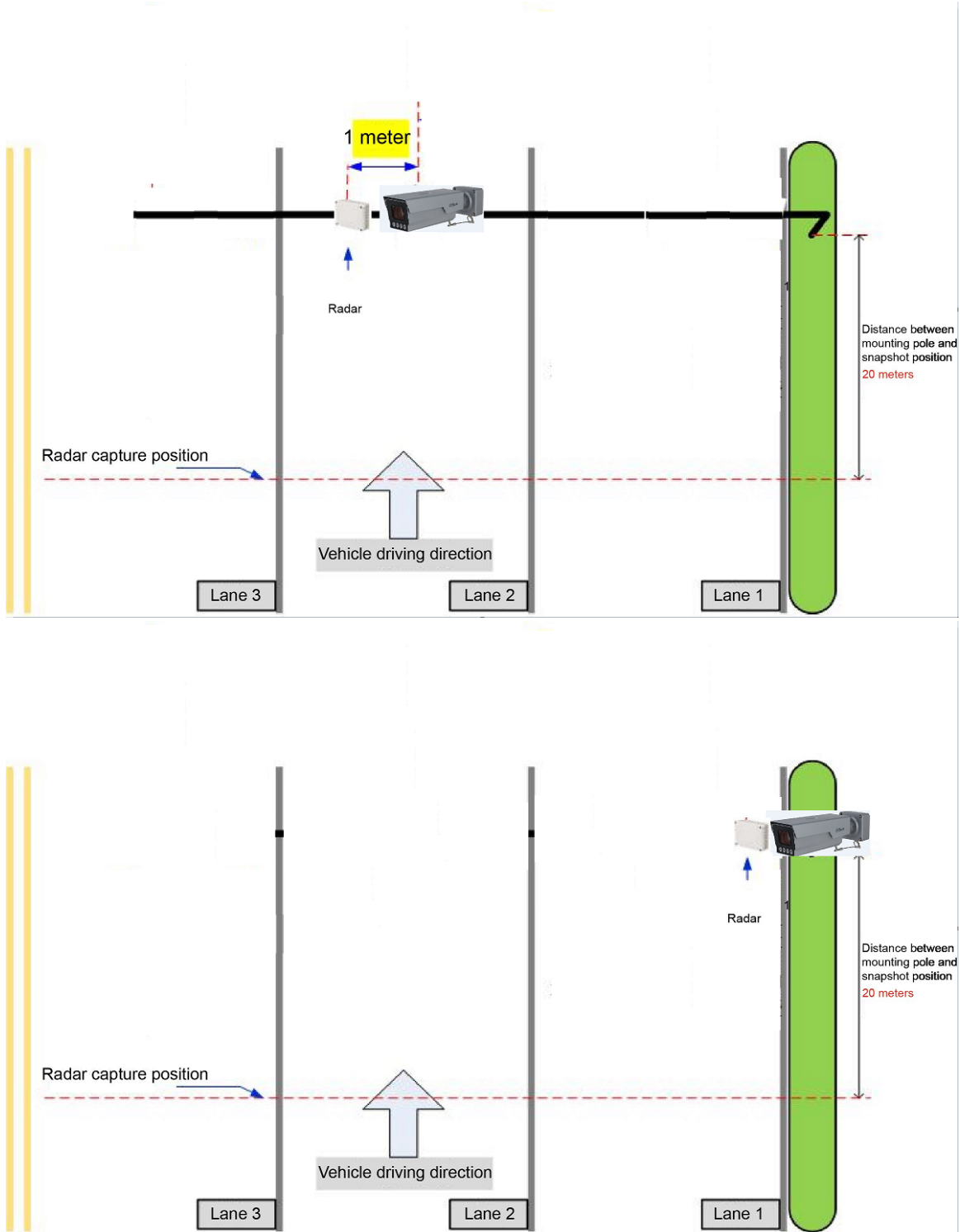

## 4.2 Installation Notes

- Traffic pole: Installed at **6 meters** high, and **19–20 meters** away from the snapshot position.
- Lens: Adjust lens focal length according to the scenario.
- Camera: Installed at center of the scenario (over the center of Lane 2).
- Radar: Installed at **1 meter** away from the center of Lane 2, with **18°** vertical angle and **3°–4°** horizontal angle recommended.

For installations of non-standard intersections, please contact our technical support to verify the scenario first before installation.

### Install on Traffic Pole with Bracket

Figure 4-2 Install on traffic pole

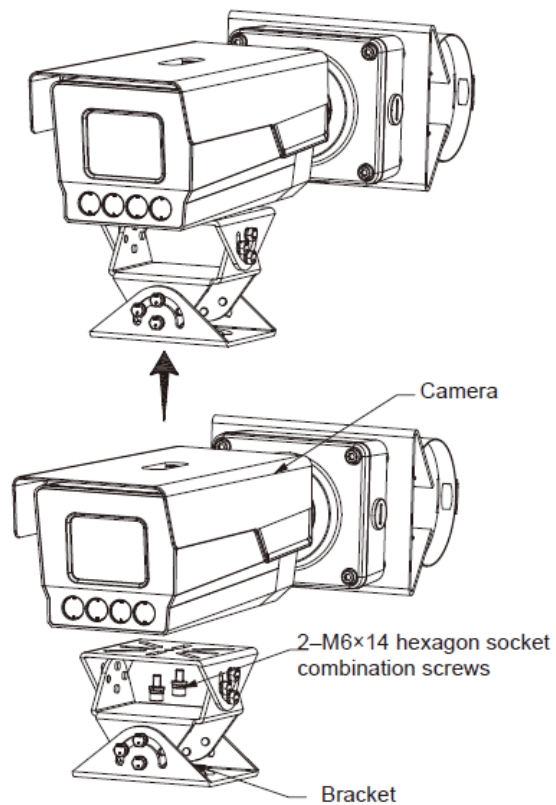



## Side Installation with Bracket

Figure 4-3 Side installation

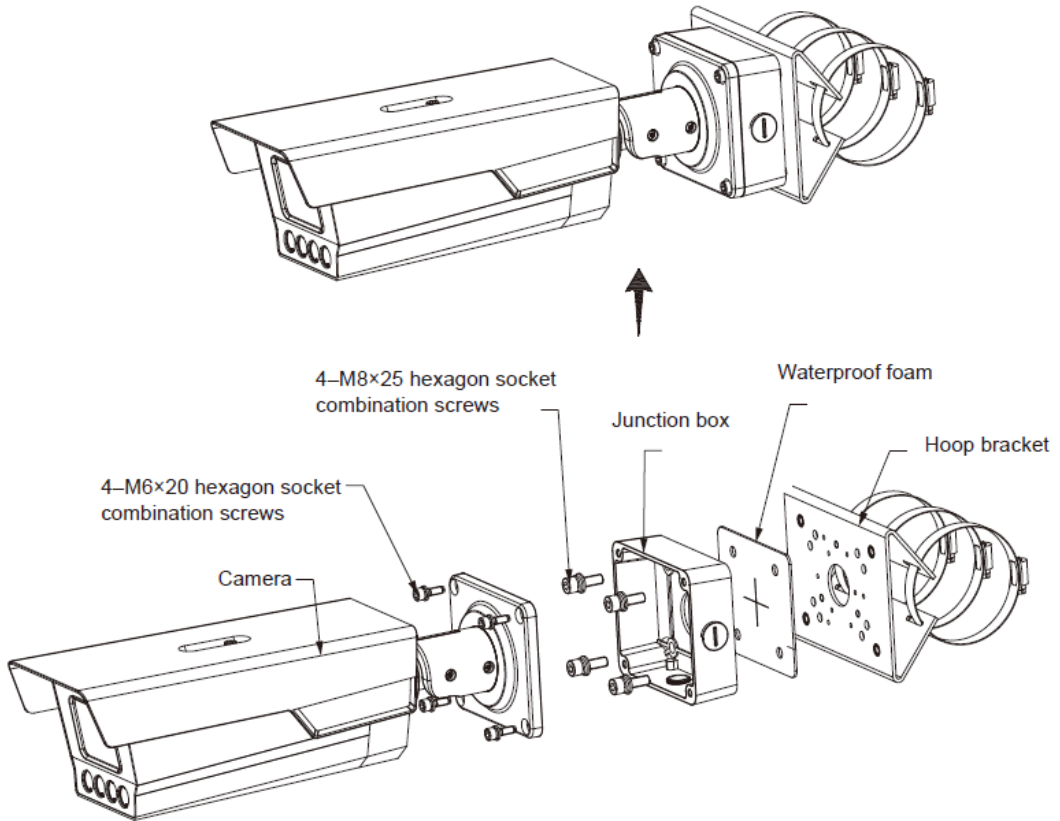

## 4.3 Installing Radar

This section takes mounting DHI-ITARD-024SA radar for example.

**Step 1** Mount the radar panel to the radar bracket.

Pay attention to the mounting direction of radar panel. The radar bracket is designed with 4 holes that can align with the holes in the panel. See Figure 4-4.

Figure 4-4 Install radar (1)



Step 2 Use screws to tighten the radar panel to the radar bracket. See Figure 4-5.

Figure 4-5 Install radar (2)

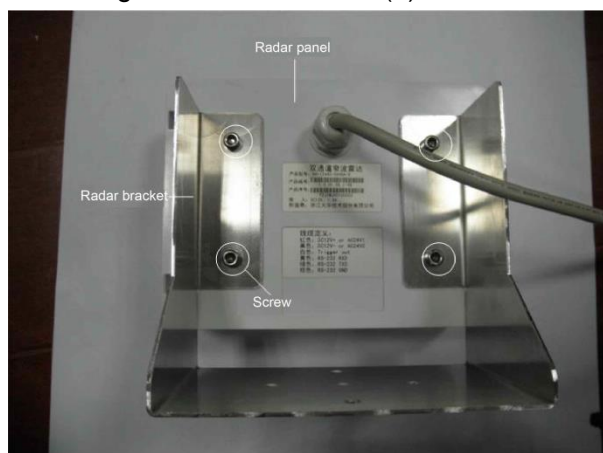

Step 3 Mount the radar bracket to PFA162 bracket. See Figure 4-6.

Figure 4-6 Install radar (3)



Step 4 Mount PFA162 bracket to the traffic pole.

Radar is successfully installed.

## 4.4 Installing Edge Storage Device

Mounting bracket for 1U edge storage device is provided. You can install edge storage device according to project requirements.

Edge storage device integrates switch and fiber optical transceiver on one device, and provides more than one method of networking to meet different client needs. The device has two Ethernet cards, default IP is: WAN Ethernet card 192.168.1.108; GIGA Ethernet card 192.168.0.108.

### Single Segment Networking Method

In this method, camera and platform are configured in the same network segment. The default Ethernet card IP address is 192.168.0.108.

Connect the platform to GIGA port through network cable, and connect cameras to switch ports. See Figure 4-7.

Figure 4-7 Single segment networking method



### Dual Segment Networking Method

In this method, the camera and the platform are configured in different network segments. The default Ethernet card IP address is 192.168.1.108. See Figure 4-8.

Figure 4-8 Dual segment networking method

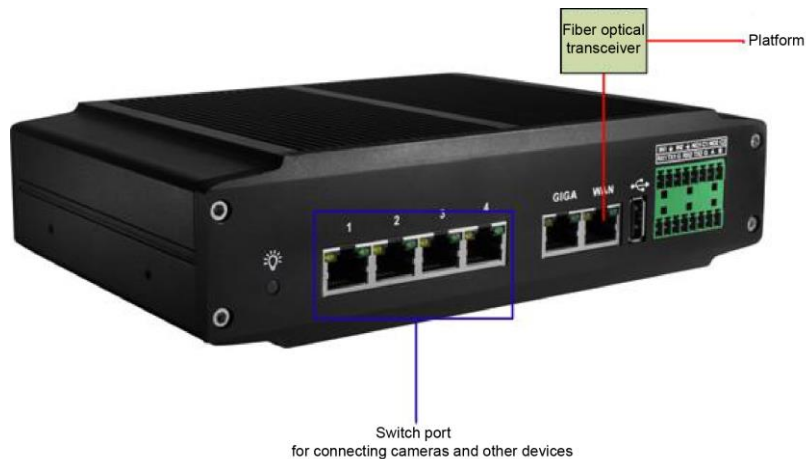

Platform in this method cannot access cameras and other devices directly, but through the edge storage device.

# 5 Wiring

## 5.1 Wiring Diagram

Figure 5-1 Wiring diagram

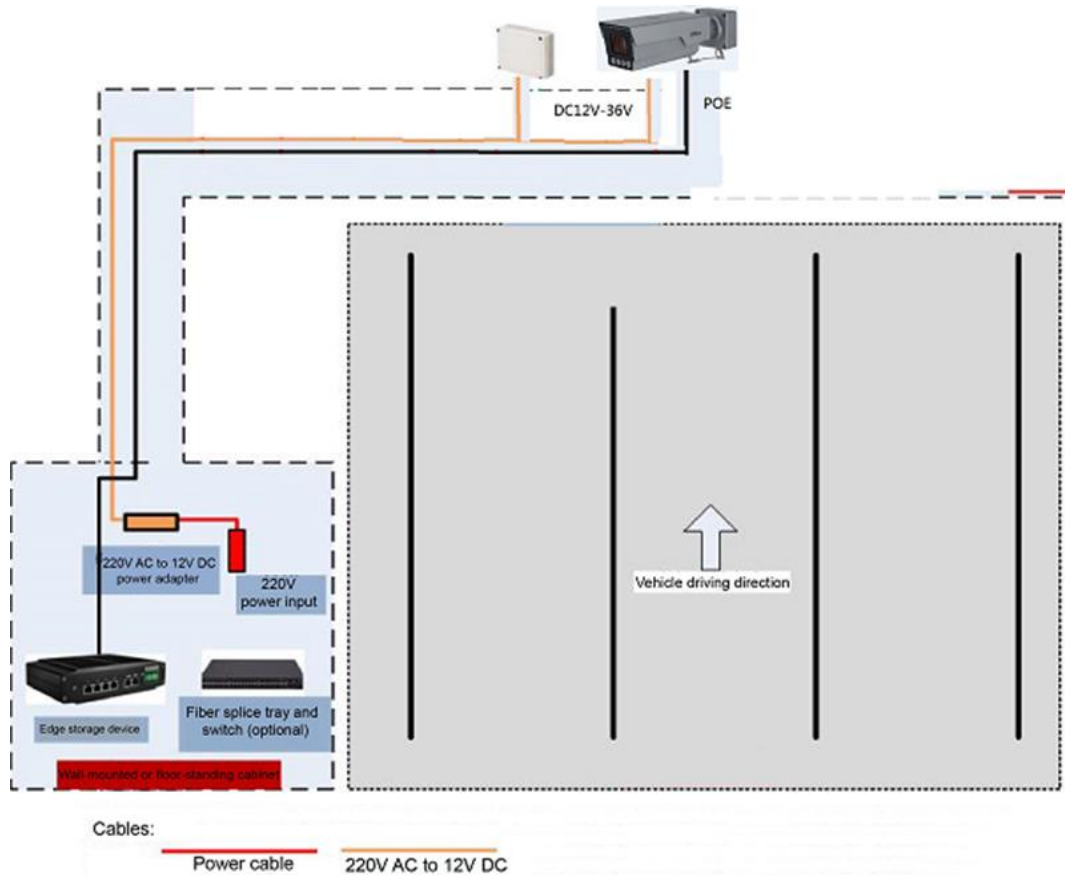

- Radar signal cable is only 1.5 meters. In scenario with multiple lanes, pay attention to use extension cord to connect the radar and the camera.
- Radar should be powered separately, and its power adapter should be placed in wall-mounted or floor-standing cabinet. Make sure to use extension cord to connect the cabinet and the pole.

## 5.2 Connecting Camera Power Cable

The camera is powered by 12-36 V DC converter, or PoE.

RVV3 × 1.5<sup>2</sup> cm cable is used for supplying 220 V power.

## 5.3 Wiring Radar

Table 5-1 Wiring camera and radar

Radar		Cable	Camera
Cable color			Port
Yellow	RXD	↔	TXD
Green	TXD	↔	RXD
Brown	GND	↔	GND

Figure 5-2 Wiring camera and radar

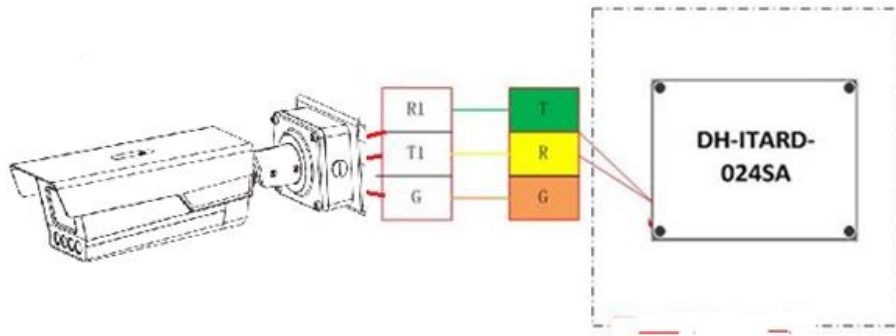

## 5.4 Connecting Radar Power Cable

Radar is supplied with 12 V DC power, and its power adapter should be placed in wall-mounted or floor-standing cabinet. Use RVVP cable to be the extension cable. Shielded layers at the two ends of RVVP cable shall be grounded.



**Make sure that all electrical devices are properly grounded during construction.**

# 6 Commissioning

## 6.1 Configuring Radar



Step 1 Configure radar parameters.

- 1) Log in to web interface of camera, and then select **Setup > ITC > Intelligent > Radar**.

Figure 6-1 Radar

- 2) Select **Enable Radar**, and then you can configure the parameters.

Table 6-1 Radar parameter description

Parameter		Description
<b>Enable Radar</b>		<b>Enable radar detection function.</b>
<b>COM SET</b>	<b>COM Port</b>	COM1/2/3 corresponds to Lane1/2/3 respectively. COM port depends on the number of lane (enable lane from <b>Setting &gt; ITC &gt; Lane Property</b> ).
	<b>Radar Type</b>	<b>Parameters of the selected radar need to be configured at the right side of the interface.</b>
<b>Speed Limit Config</b>		<ul style="list-style-type: none"> <li>● <b>For Size disabled</b> You can configure the low/high speed limit.</li> <li>● <b>For Size enabled</b> You can configure the low/high speed limit by vehicle size (small vehicles (SV) and large vehicles (LV)).</li> </ul>
<b>ITARD-024 SA-I</b>	<b>Work Mode</b>	<p>The way of sending information captured by Radar.</p>  <p>Currently, the Camera supports only <b>Single</b>. Special program is required if you want to send the information in continuous or manual way.</p>
	<b>Interval</b>	<p>The radar will recognize only one subject within the interval.</p>  <p>This function is available with the support of special program.</p>

Parameter		Description
	Detect Mode	The detection direction of radar.
	Angle	The angle between the directions of the radar beam and the vehicle.
	Sensitivity	You can select the sensitivity of snapshot by radar. The larger the value, the more sensitive the radar.
	Trigger Speed	Snapshot will be triggered when the vehicle speed reaches the trigger speed.
	Pre Speed Wait	Recognizing the vehicle speed. By video analyse and radar detection, the Camera can detect the vehicle speed. If the speed is detected within the range of Pre Speed Wait and Delay Speed Wait, then such speed will be the detected speed;
	Delay Speed Wait	if out of such range, then the speed will be a random value within speed limit.

## 6.2 Commissioning Radar

Step 1 Check the cable connection of radar.

The blue indicator on the radar is on, then the radar is properly connected. See Figure 6-2.

Figure 6-2 Radar indicator



Step 2 Adjust the angle of radar. The radar should be 1 meter away from the center of Lane 2, with 18° vertical angle and 3°–4° horizontal angle recommended.

- Vertical angle of radar: Make sure the distance between the capture position of radar and the mounting pole of camera is between 20 to 22 meters. See Figure 6-3.
- Horizontal angle of radar: Make sure the deviation between the captured vehicle and the capture line is within 2 meters. See Figure 6-3.

Figure 6-3 Commissioning radar

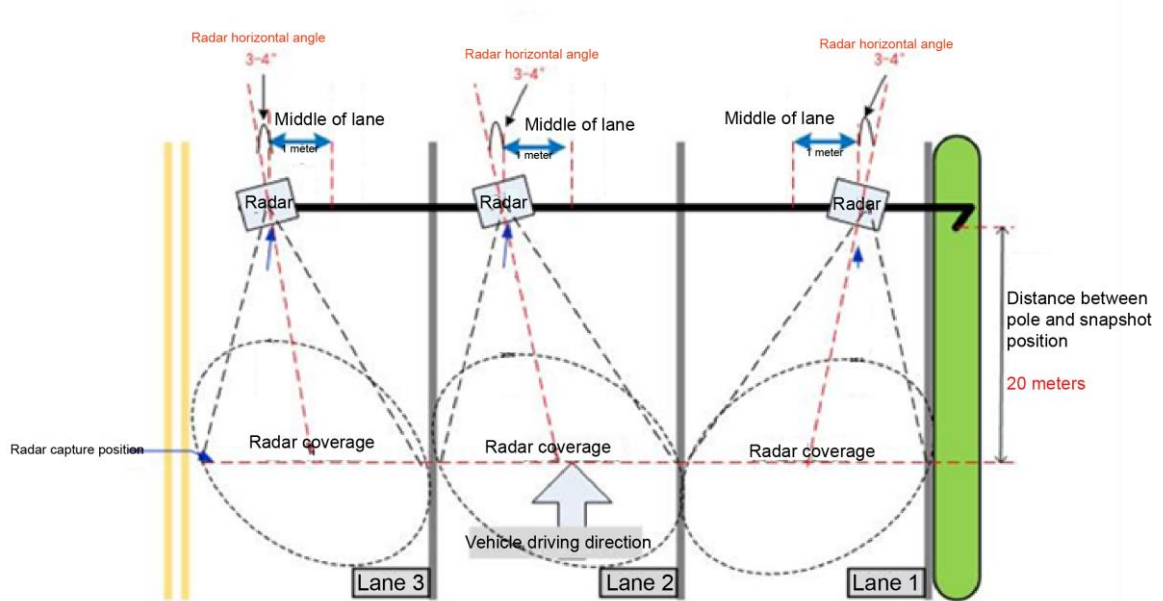

## 6.3 Commissioning Strobe

Step 1 Check the cable connection of strobe.

You can check whether the strobe flashes in the video image (set the shutter speed of camera as 0–3, and gain as 30). If it flashes, then it is properly connected. If not, check the cable connection again.



We recommend to doing the commissioning at night.

Step 2 Properly adjust the angle of strobe.

Make sure the light spot in the video image at the center of scenario horizontally and 1/2 of the scenario vertically (set the shutter speed of camera as 0–3, and gain as 30). See Figure 6-4. If not, adjust the angle of the flashing light.



- We recommend to doing the commissioning at night.
- Pay attention to the vehicle plate when adjusting the strobe. Make sure the strobe is not overexposed.



Figure 6-4 Commissioning flashing light

