

## DT8016AF4 / DT8016AF5 DUAL TEC® Motion Sensor with Anti-Mask

[FR] [ES] [SE] [NL] [IT] [RU] [UK]

1

[EN] = installation agréé / instalación homologado / godkänd installation / goedgekeurde installatie / installazione omologato / xopousee место / approved installation

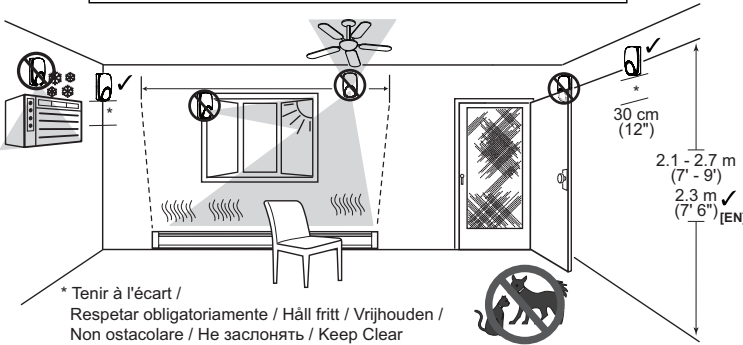

2

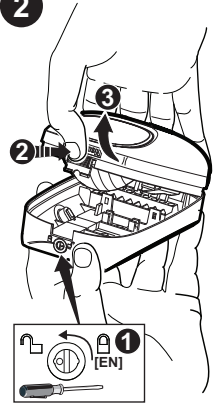

3

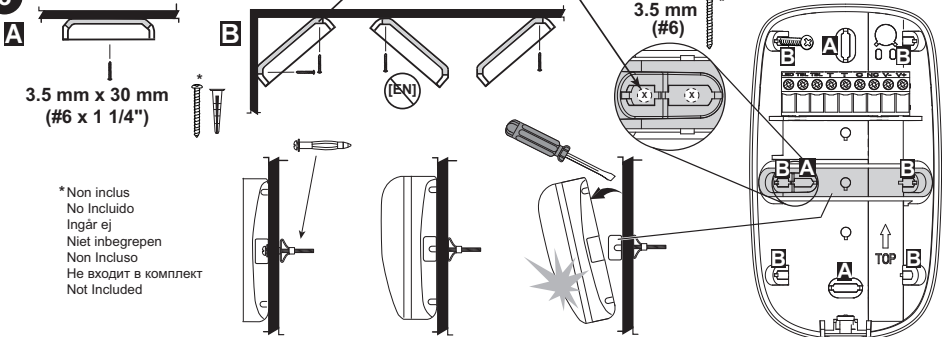

4

Réglage des résistances (EOL) / Ajustes de RFL / EOL-inställningarna / EOL inställingen / Regolazioni EOL / Настройки EOL / EOL Settings

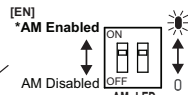
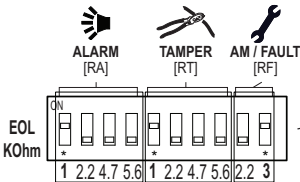

Anti-masque  
Antienmascaramiento  
Anti-masking  
Antimascheramento  
АНТИМАСКИНГ  
Anti-mask

\* [EN] Réglage de la portée hyper / Ajuste del rango de detección / Justeringsområde för mikrovåg / Anpassing bereik radiofrekventie / Regolazione della portata / Настройка микроволнового диапазона / Microwave Range Adjustment

MIN \* [EN] MAX MW SENSITIVITY

Remarque: Réglée au minimum, la couverture du détecteur est réduite à 5m.

Nota: Ajuste en mínimo, el rango del sensor se reduce a 5 m.

OBSI Ståll in på minsta värdet, detektorområdet minskas till 5 m.

Öppmerking: Ingesteld op minimum wordt het sensor bereik gereduceerd tot 5m.

Nota: impostare al minimo, la portata del sensore è ridotta a 5m.

Примечание: При установке на минимум дальность действия датчика сокращается до 5 м.

Note: Set at minimum, the sensor range is reduced to 5m.

\* Réglage usine / valores de fábrica / Fabriksinställning / fabriksinställingen / programmazione di fabbrica / Заводские настройки / factory default

5

0.2-0.52mm<sup>2</sup>

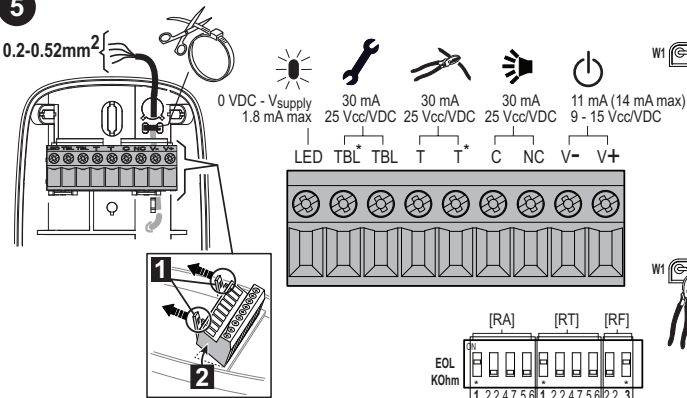

\* 1 boucle / bucle / krets / lus / loop / петля / loop

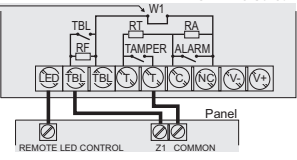

2 boucles / bucles / kretsar / lussen / loop / петли / loops

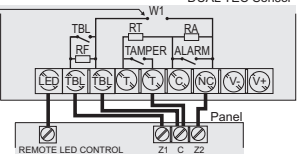

6

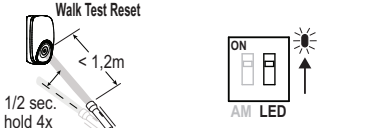
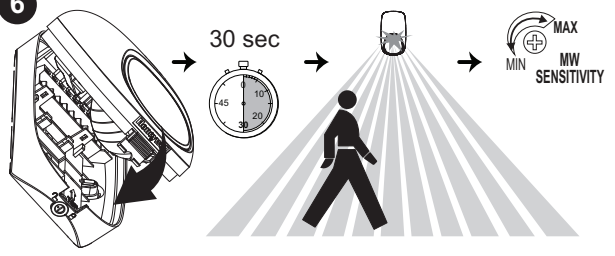

LED	Power Up	Walk Test [10 min.]	Normal	Trouble	
				Fault	Anti-Mask
Red	Slow Blink	ON Alarm	ON Alarm	Fast Blink	OFF
Yellow	OFF	ON Microwave	OFF	OFF	Fast Blink
Green	OFF	ON PIR	OFF	OFF	OFF

7

Vue de dessus  
Vista Desde Arriba  
Sett ovanifrån  
Bovenanzicht  
Vista in pianta  
Вид сверху  
Top View

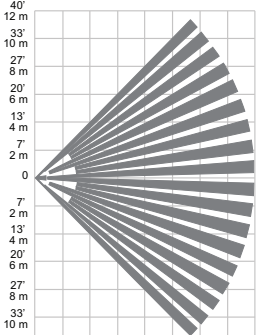

Vue de côté  
Vista Lateral  
Sett från sidan  
Zijaanzicht  
Vista in sezione  
Вид сбоку  
Side View

Approval Listings:



EN50131-2-4:2008, Security Grade 3, Environmental Class II. Suitable for connection to an EN 60950 Class II Limited Power Source.

Note: In EN 50131-2-4 compliant installations, mount the sensor at 2.3m, do not use only the right side corner mounting holes, enable lock window, set the microwave sensitivity to maximum and lock the sensor housing with the cover lock (see "[EN]" where noted in Steps 1-4).

Important: Le détecteur doit être testé au moins une fois par an.

Important: El sensor debe comprobarse al menos una vez al año.

Viktig! Detektorn ska testas minst en gång per år.

Belangrijk: De sensor dient minstens één keer per jaar getest te worden.

Importante: É necessário sottoporre il sensore a test almeno una volta l'anno.

Важное замечание: Датчик следует проверять минимум раз в год ежегодно.

IMPORTANT: The sensor should be tested at least once each year.



AF86

DT8016AF5  
PD6662-2010



NF&A2P 3 bouclers (référéntiel NF324-H58) et conforme aux normes EN50131-2-4 et FTTCS0131-2-4. IP30 IK04

DT8016AF4 - N° de certificat: 2831420015

DT8016AF5 - N° de certificat: 281420015

Organisme de certification: CNPP Cert. : www.cnpp.com et AFNOR Cert. : www.marque-nf.com

Honeywell Security Group - BP1219  
1198 avenue du docteur Maurice Donat  
Sophia Antipolis  
06254 Mougins Cedex.  
TEL: +33.4.92.94.29.50  
FAX: +33.4.92.94.29.60

DT8016AF4  
INCERT  
B-893-0012

Pour toutes informations supplémentaires, se référer svp à notre site Web :  
Para cualquier información adicional, por favor visite nuestra Website.  
Mer information finns på vår webbplats.  
Voor verdere informatie, bezoek aub onze website op:  
Per ogni ulteriore informazione, si prega di fare riferimento al nostro sito Web:  
Дополнительную информацию см. на нашем веб-сайте:  
For any additional information, please refer to our Website:  
<http://www.honeywell.com/security/emea/hscdownload>  
Ou contacter: / o contacte con: / Eller kontakta: / of neem contact op met: / o contactare: / Или обратитесь / or contact:  
Honeywell Security Group  
Newhouse Industrial Estate  
Motherwell  
Lanarkshire ML1 5SB  
Tel: +44(0)1698 738200  
Email: UK64Sales@Honeywell.com



Zones / Zonas / Zoner / Zones / Zone di rilevazione/ Зоны / Zones

A	2 Basses / Ángulo 0 / Vy nedatí / Kruipzones / Antistrisciamiento / Нижний обзор / Look-down
B	12 Courtes / Corto / Lågre / Kort / Inferiori / Нижняя / Lower
C	10 Intermédiaires / Intermedias / Mellanlåg / Midden / Intermedie / Промежуточная / Intermediate
D	36 Longues / Largo / Lång / Lunga portata / Длинная / Long

Contacter un revendeur Honeywell autorisé pour obtenir des informations sur la garantie de ce produit.  
Por favor contacte con su distribuidor Honeywell Security para información sobre la garantía del producto.  
Kontaktka den lokala auktoriserade representanten för Honeywell för produktgarantiförklaring.  
Voor informatie over de productgarantie kunt u het beste contact opnemen met de lokale Honeywell vertegenwoordiger.  
Contatti il suo rappresentante Honeywell per ulteriori informazioni sui prodotti e garanzie.  
\*Чтобы получить информацию о гарантии на продукцию, обратитесь к местному авторизованному представителю Honeywell.  
Please contact your local authorised Honeywell representative for product warranty information.

© 2014 Honeywell International Inc.  
Honeywell and DUAL TEC are registered trademarks of Honeywell International Inc. All other trademarks are the properties of their respective owners. All rights reserved.  
Made in China.



P/N 800-13812 Rev E