

2 Structure

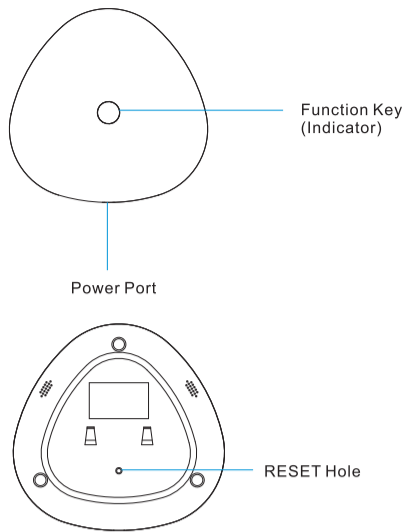

Description of Indicator

Indicator	Status
Blue on	Normal
Blue flashes slowly	AP config mode
Blue flashes quickly	Wireless pairing mode
Red flashes quickly	Alarm happened or connecting internet
Red on	Network connection failed

Description of Function Key

Function Key	Status
Press shortly	Wireless pairing mode
Press for more than 5 seconds	AP config mode

RESET Hole

Press the RESET button for 6s when the power is on, until indicator is off. Restart the hub and restore factory default settings.

3 Start

3.1 Connect Power

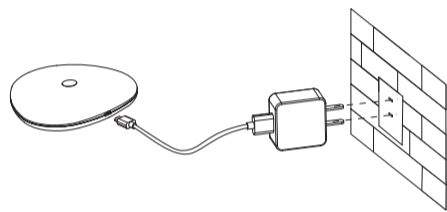

Figure 3-1

3.2 Download APP

Scan QR code below, or search APP client in APP market, download and login APP.

Please refer to APP manual for details.



Note

- Android user, please go to Google Play Store to search and download gDMSS.
- Apple user, please go to Apple Store to search and download iDMSS.

3.3 Add Device

- For the first time, initialize the hub first and carry out AP configuration. For details, please refer to "3.3.1 Device Initialization" and "3.3.2 AP Config".
- In case that info of WiFi connected with the hub shall be modified during normal use, carry out AP configuration process again to modify it. For details, please refer to "3.3.2 AP Config".
- In case that other APP clients need to add this hub during normal use, add them through P2P scanning. For details, please refer to "3.3.3 P2P Scanning".

3.3.1 Device Initialization

Caution

Please make sure that the mobile phone has enabled WiFi function.

Step 1 Open APP, press [Add Device] or [Add Device] in top right corner, and then press [Add Device]. Open "Add Device" interface.

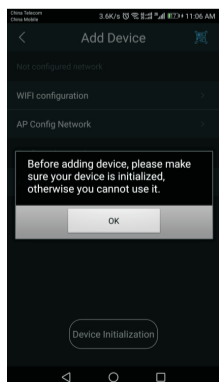

Figure 3-2

Intelligent Alarm Hub

Quick Start Guide

V1.1.0

1.2.51.32.LJ0913-000

Preface

Overview

This document mainly introduces functional feature, installation wiring and operation of wireless intelligent hub.

Symbol Definition

The following symbols may appear in the document. Please refer to the table below for the respective definition.

Symbol	Note
	Danger: It indicates a potentially hazardous situation which, if not avoided, could result in death or serious injury.
	Warning: It indicates a moderate or low level of potential danger which, if not avoided, could result in minor or moderate injury.
	Caution: It indicates a potential risk that, if ignored, could result in damage to device, loss of data, degraded performance, or unpredictable results.
	Anti-static: It means electrostatic-sensitive device.
	Protection against electric shock: It means high-voltage danger.
	Laser radiation: It means intensive laser radiation.
	Tip: It means that it can help you to solve some problems or save your time.
	Note: It means the additional information, which is the emphasis and supplement of the main body.

Important Safeguards and Warnings

The following description is the correct application method of the device. Please read the manual carefully before use, in order to prevent danger and property loss. Strictly conform to the manual during application and keep it properly after reading.

Operating Requirement

- Please don't place and install the device in an area exposed to direct sunlight or near heat generating device.
- Please don't install the device in a humid, dusty or fuliginous area.
- Please keep its horizontal installation, or install it at stable places, and prevent it from falling.
- Please don't drip or splash liquids onto the device; don't put on the device anything filled with liquids, in order to prevent liquids from flowing into the device.
- Please install the device at well-ventilated places; don't block its ventilation opening.
- Use the device only within rated input and output range.
- Please don't dismantle the device arbitrarily.
- Please transport, use and store the device within allowed humidity and temperature range.

Power Requirement

- Please make sure to use batteries according to requirements; otherwise, it may result in fire, explosion or burning risks of batteries!
- To replace batteries, only the same type of batteries can be used!
- The product shall use electric wires (power wires) recommended by this area, which shall be used within its rated specification!
- Please make sure to use standard power adapter matched with this device. Otherwise, the user shall undertake resulting personnel injuries or device damages.
- Please use power supply that meets SELV (safety extra low voltage) requirements, and supply power with rated voltage that conforms to Limited Power Source in IEC60950-1.
- For specific power supply requirements, please refer to device labels.
- Products with category I structure shall be connected to grid power output socket, which is equipped with protective grounding.
- Appliance coupler is a disconnecting device. During normal use, please keep an angle that facilitates operation.

1 Checklist

Please check if device appearance is damaged obviously, and check if accessories are complete. Please refer to quick start guide.

Names of Accessories	Quantity
Intelligent Alarm Hub	1
Power Adaptor	1
Manual	1
Foam Rubber	1
Expansion Pipe	3
Self-tapping Screw	3

Table 1-1

Step 2 Press [OK] to close the prompt, and then press [Device Initialization].

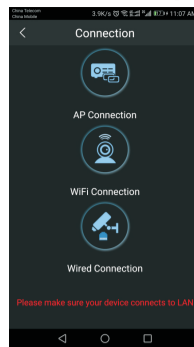

Figure 3-3

Step 3 Take down the bracket on the hub, press [Scan QR Code], scan QR code on the back of the device and obtain device SN.

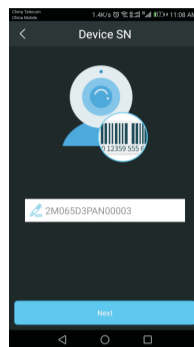

Figure 3-4

Step 4 Press [Next]. Display "AP Config" interface.

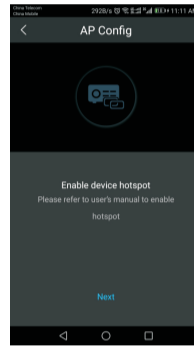

Figure 3-5

Step 5 Press [Next]. Display current WiFi connection interface.

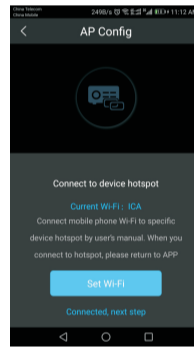

Figure 3-6

Step 6 Short press function key, so blue indicator light will be normally on. Then, press function key for more than 5s. Blue indicator will flash slowly, indicating that AP mode is on.

Step 7 Press [Set WiFi]. Display WiFi list.

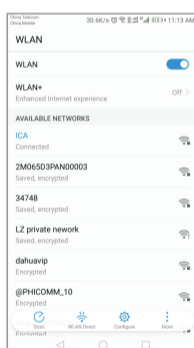

Figure 3-7

Step 8 Select device hotspot, input the password and connect (hotspot name is device SN and default password is 12345678).

Note

If the mobile phone has once connected this device hotspot, it has no need to input hotspot password again.

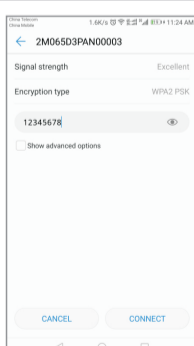

Figure 3-8

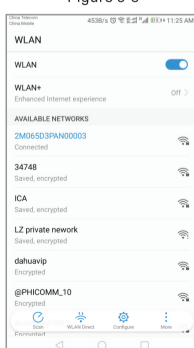

Figure 3-9

Step 9 In APP interface, confirm whether current WiFi is device hotspot.

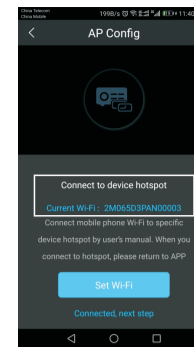

Figure 3-10

Step 10 Press [Connected, next step] and search the device. After it is found successfully, display password setting interface.

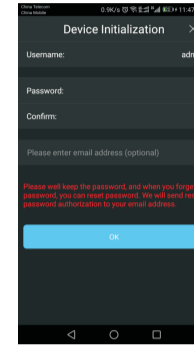

Figure 3-11

Step 11 Set device password and press [OK] to initialize the device. Password should be set to 8 and above, and contains at least two categories, such as upper-and lowercase letters, numbers and symbols.

Step 12 Press [OK] to complete initialization.

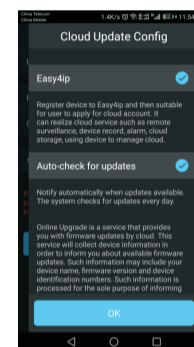

Figure 3-12

3.3.2 AP Config

Caution

Make sure that the device has completed initialization.

Step 1 In "Add Device" interface, press [AP Config Network]. Display "AP Config" interface.

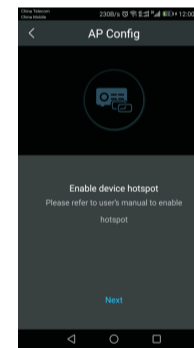

Figure 3-13

Step 2 Press [Next] to display current WiFi connection.

- If current WiFi is device hotspot, press [Connected, next step] and continue further configurations. For details, please refer to "Step 7~ Step 10".

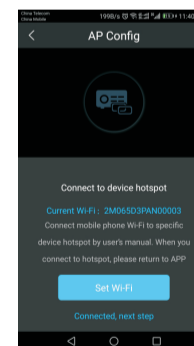

Figure 3-14

- If current WiFi is "not connected", enable device hotspot and continue further configurations. For details, please refer to "Step 3~ Step 10".

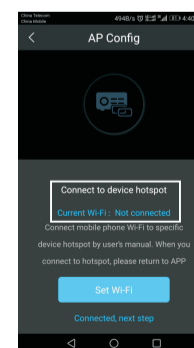

Figure 3-15

Step 3 Short press function key, so blue indicator light will be normally on. Then, press function key for more than 5s. Blue indicator will flash slowly, indicating that AP mode is on.

Note

Omit this step if the hub is in AP mode already.

Step 4 In APP interface, press [Set WiFi]. Display WiFi list.

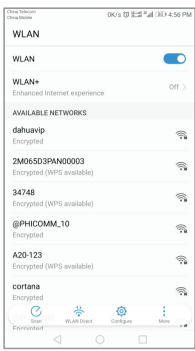

Figure 3-16

Step 5 Select device hotspot, input the hotspot password (hotspot name is device SN and default password is 12345678), connect the mobile phone to device hotspot and connect.

Note

If the mobile phone has once connected this device hotspot, it has no need to input hotspot password again.

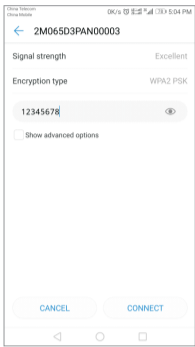

Figure 3-17

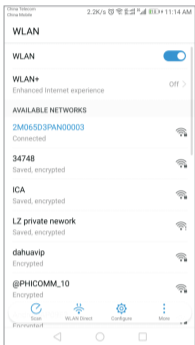

Figure 3-18

Step 6 In APP interface, press [Connected, next step].

Step 7 Press [Scan QR], scan QR code on the back of the device, obtain device SN and input device password. Start to search nearby available WiFi.

Note

Password is the password set during device initialization.

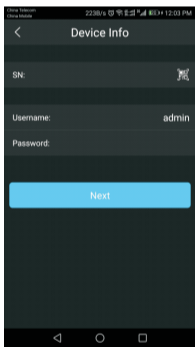

Figure 3-19

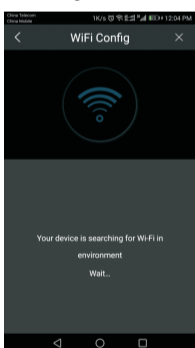

Figure 3-20

Step 8 In the list of available WiFi network, select the WiFi, input password and press [OK]. At this time, red indicator flashes slowly, indicating hub is connecting selected WiFi.

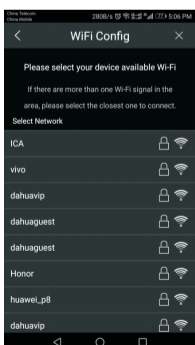

Figure 3-21

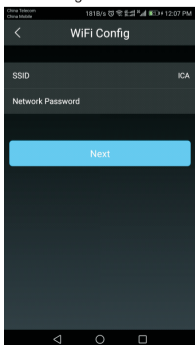

Figure 3-22

Step 9 Observe status of hub indicator.

- If it turns from slow pulse red to solid blue, it is connected successfully. Press [Yes] to continue.
- If it turns from slow pulse red to solid red, it fails to be connected. Press [Load Again] to repeat above steps.

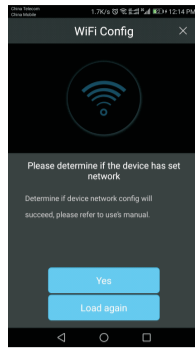

Figure 3-23

Step 10 Input hub name and press [View Alarm Hub]. Press [Home] to arm or disarm.

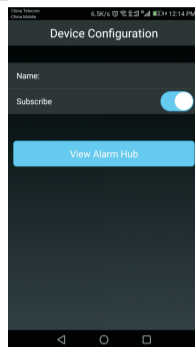

Figure 3-24

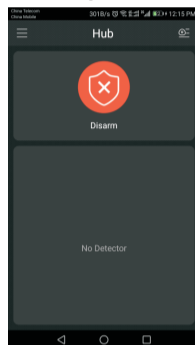

Figure 3-25

3.3.3 P2P Scanning

Caution

Make sure that the device has completed initialization and network configuration.

Step 1 In "Add Device" interface, press [Add Device].

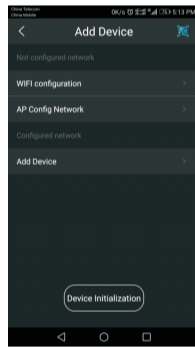

Figure 3-26

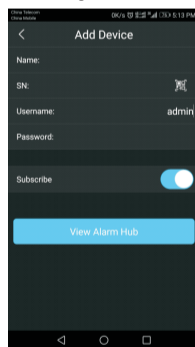

Figure 3-27

Step 2 Press [Scan QR], scan QR code on the back of the device, obtain device SN, input hub name and password.

Step 3 Press [View Alarm Hub].

Press [Home] to arm or disarm.

3.4 Detector/Siren Pairing

In pairing mode of the hub, multiple detectors and sirens can be added one by one.

Step 1 Short press the function key of hub to enter pairing mode, and then the blue indicator flashes quickly.

Step 2 Power on the detector/siren. Its indicator light is normally on and then flashes fast, representing that it enters pairing mode and starts pairing.

- Pair successfully when the hub gives off prompt tone of "beep".

- Fail to pair if red light flashes slowly for 3 times. Repeat above steps, until it is paired successfully. Or slide the tamperproof switch of the case and pair manually.

Note

Hub pairing process will last 120s. After that, exit pairing mode automatically, and blue indicator light is normally on. During pairing, short press the function key, to stop pairing manually.

Take "wireless PIR detector" as an example, position of tamperproof switch is shown as follows:

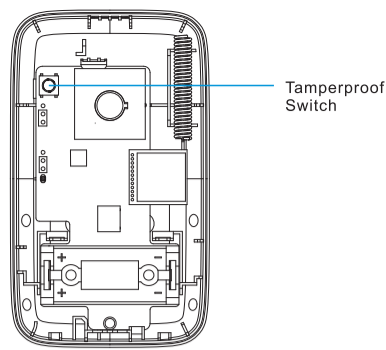

Figure 3-28

3.5 Detector Enters Armed Mode

Only when the detector is enabled, can the alarm be triggered under arm mode.

Caution

After enabling the detector, it shall be armed again to take effect.

Step 1 Press [Home] first and then, press [Display mode setting interface].

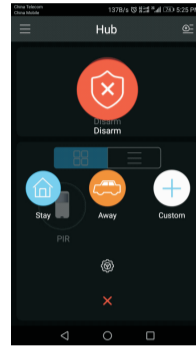

Figure 3-29

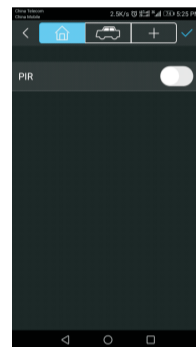

Figure 3-30

Step 2 Press [Power] to enable the detector. Press menu key at the top to switch armed mode.

- [Stay]: stay.
- [Away]: away.
- [Custom]: custom.

Step 3 Press [Power] to save the settings.

3.6 Clear Detector/Siren Pairing Info

If the detector needs to be used with a new hub or restore factory defaults, slide the tamperproof switch of the case for 5 times quickly, to clear config info and restore factory defaults. The indicator light will be normally on and then flash if it clears successfully.

3.7 Remote Control Pairing

Through pairing, multiple wireless remote controls can be bound with the hub, so as to realize quick arm, disarm and emergency alarm function.

Step 1 Short press the function key of hub to enter pairing mode, and then blue indicator flashes quickly.

Step 2 Press any key of wireless remote control for 2s, and then the hub gives off the prompt tone of "beep", which means pairing success. Otherwise, pairing fails. Please pair again.

Note

After entering pairing mode, multiple wireless remote controls can be added in sequence.

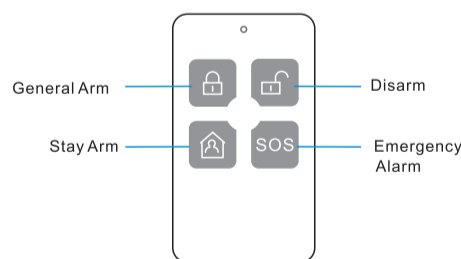

Figure 3-31

3.8 Delete Detector, Siren and Remote Control

- Method 1: In APP, check accessory details and delete according to prompts.
- Method 2: Press the RESET button for 6s when the power is on until indicator is off, then hub will restart and red flashes slowly, indicating all config info has been cleared and factory default settings have been restored.

4 Product Installation

This product provides installation with screw and foam rubber.

4.1 Installation with Screw

Step 1 Take down the bracket and drill holes in the wall according to bracket hole positions.

Step 2 Insert expansion pipe into the hole.

Step 3 Fix the bracket with self-tapping screw.

Step 4 Buckle the hub into the bracket from top to bottom.

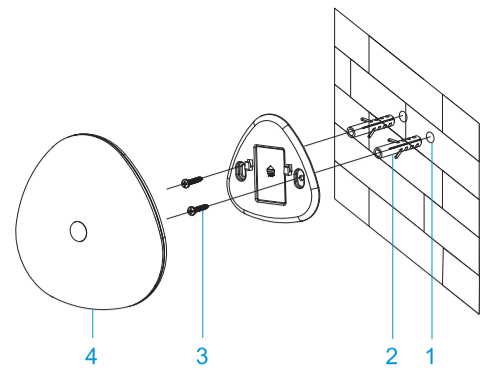

Figure 4-1

4.2 Installation with Foam Rubber

Step 1 Paste 3M foam rubber on the bracket.

Step 2 Paste the device to an appropriate position on the wall.

5 FAQ

Q1: Intelligent alarm hub cannot be booted normally?
A: Please check input power of the hub (including adapter and USB cable).

Q2: Accessory pairing fails?

A:

- Please check if the hub is in wireless pairing mode.
- Please check if electric quantity of accessory battery is sufficient.
- Please check if the accessory has connected with other hubs.
- Please clear configuration and try pairing again.
- Please check if the accessory is too far away from the hub and beyond effective range. Please move the detector closer and try pairing again.

Q3: Accessory is triggered without any response?

A:

- Please check if electric quantity of accessory battery is sufficient.
- Please check if the accessory has been added to arm mode.
- Please check if the hub is armed.
- Please check if cables of the accessory drop off.
- Please check if the accessory exceeds detection scope.

Q4: Mobile phone client doesn't receive messages after an alarm is triggered?

A:

- Please check if network connection of the hub or router is normal.
- Please check if alarm subscription of APP is enabled.

Q5: The accessory goes online and offline frequently?

A:

- Please check if the hub or accessory is power-off frequently.
- Please check if the hub network is normal.
- Please check if the accessory is too far away from the hub and at the critical state of communication.

Appendix 1 Technical Parameters

Parameter	Description
Main Processor	MT7688AN
Wireless Carrier Frequency	433/868/915MHz
WiFi Carrier Frequency	2.4GHz (support 802.11b/g/n Standard)
Wireless Transmitting Power	≤10dBm
WiFi Transmitting Power	≤18dBm
Wireless Transmission Distance	1000m (open air)
Wireless Device Access	Max. 32
Supply Voltage	DC5V
Power Consumption	≤5W
Working Temperature	-10°C~55°C
Installation	Desktop and wall-mounted
Dimension	140mm×142mm×19.5mm (length* width* thickness)
Weight	0.2kg